



SECTION A. Table of Contents

Section A. Facility/Source Identification

Table of Contents
Site Inventory List

Section B. General Title V Requirements

- #001 Definitions
- #002 Prohibition of Air Pollution
- #003 Property Rights
- #004 Permit Expiration
- #005 Permit Renewal
- #006 Transfer of Ownership or Operational Control
- #007 Inspection and Entry
- #008 Compliance Requirements
- #009 Need to Halt or Reduce Activity Not a Defense
- #010 Duty to Provide Information
- #011 Reopening and Revising the Title V Permit for Cause
- #012 Reopening a Title V Permit for Cause by EPA
- #013 Operating Permit Application Review by the EPA
- #014 Significant Operating Permit Modifications
- #015 Minor Operating Permit Modifications
- #016 Administrative Operating Permit Amendments
- #017 Severability Clause
- #018 Fee Payment
- #019 Authorization for De Minimis Emission Increases
- #020 Reactivation of Sources
- #021 Circumvention
- #022 Submissions
- #023 Sampling, Testing and Monitoring Procedures
- #024 Compliance Certification
- #025 Recordkeeping Requirements
- #026 Reporting Requirements
- #027 Operational Flexibility
- #028 Risk Management
- #029 Approved Economic Incentives and Emission Trading Programs
- #030 Permit Shield
- #031 Reporting
- #032 Report Format

Section C. Site Level Title V Requirements

- C-I: Restrictions
- C-II: Testing Requirements
- C-III: Monitoring Requirements
- C-IV: Recordkeeping Requirements
- C-V: Reporting Requirements
- C-VI: Work Practice Standards
- C-VII: Additional Requirements
- C-VIII: Compliance Certification
- C-IX: Compliance Schedule

Section D. Source Level Title V Requirements

- D-I: Restrictions
- D-II: Testing Requirements
- D-III: Monitoring Requirements
- D-IV: Recordkeeping Requirements
- D-V: Reporting Requirements



SECTION A. Table of Contents

D-VI: Work Practice Standards
D-VII: Additional Requirements

Note: These same sub-sections are repeated for each source!

Section E. Source Group Restrictions

E-I: Restrictions
E-II: Testing Requirements
E-III: Monitoring Requirements
E-IV: Recordkeeping Requirements
E-V: Reporting Requirements
E-VI: Work Practice Standards
E-VII: Additional Requirements

Section F. Alternative Operating Scenario(s)

F-I: Restrictions
F-II: Testing Requirements
F-III: Monitoring Requirements
F-IV: Recordkeeping Requirements
F-V: Reporting Requirements
F-VI: Work Practice Standards
F-VII: Additional Requirements

Section G. Emission Restriction Summary

Section H. Miscellaneous

**SECTION A. Site Inventory List**

Source ID	Source Name	Capacity/Throughput		Fuel/Material
111	A-1 MIXING (SCIEN FC 1) & PASTING (FARR CC 4)	200.000	Each/HR	STORAGE BATTERIES
112	A-1 DRY CHARGE AREA (SCIEN FC 7, SCIEN FC 6 & FARR CC 4)	200.000	Each/HR	STORAGE BATTERIES
113	A-1 GRIDCAST (SCIEN FC 6 & SCIEN FC 5)	200.000	Each/HR	STORAGE BATTERIES
114	A-1 BATTERY ASSM (FARR CC 4, SCIEN FC 6 & FC 7)	200.000	Each/HR	STORAGE BATTERIES
116A	A-1 LEAD OXIDE STORAGE SILOS (2) (BIN VENTS)			
126	LEAD OXIDE MILL 1	750.000	CF/HR	NATURAL GAS
		2,600.000	Lbs/HR	LEAD OXIDE
127	LEAD OXIDE MILL 3	750.000	CF/HR	NATURAL GAS
		2,600.000	Lbs/HR	LEAD OXIDE
128	LEAD OXIDE MILL 2	750.000	CF/HR	NATURAL GAS
		2,600.000	Lbs/HR	LEAD OXIDE
129	LEAD OXIDE MILL 4	750.000	CF/HR	NATURAL GAS
		2,600.000	Lbs/HR	LEAD OXIDE
130	A-2 BATTERY ASSEMBLY C (SCIENTIFIC FC 2)	1,100.000	Each/HR	STORAGE BATTERIES
131	A-2 MIXING (SCIEN FC 9) & PASTING (SCIEN FC 2 & 6)	1,100.000	Each/HR	STORAGE BATTERIES
132	A-2 COS & ENVELOPE (SCIEN FC 1 & SCIEN FC 10)	1,100.000	Each/HR	STORAGE BATTERIES
133	A-2 GRIDCAST (SCIEN FC 7, 2 & 10 & SCIEN FC 1)	1,100.000	Each/HR	STORAGE BATTERIES
133A	A-2 CONCASTER (SCIEN FC #1 & SCIEN FC #10)	1,100.000	Each/HR	STORAGE BATTERIES
133E	A-2 STRIP/PUNCHCAST MACH #1-3 (SCIEN FC 1)			
134	A-2 ASSEMBLY (SCIENTIFIC FC 8)	1,100.000	Each/HR	STORAGE BATTERIES
135	IND LEAD OXIDE RECEIVING TANK (3) (BIN VENT)			
136	A-2 LEAD OXIDE STORAGE SILOS (7) (BIN VENTS)	9.500	Tons/HR	LEAD OXIDE
138	A-2 BATT ASMBLY (FARR CC 3)	1,100.000	Each/HR	STORAGE BATTERIES
139	A-2 BATTERY FORMATION (8 MIST ELIMN)	1,100.000	Each/HR	STORAGE BATTERIES
140	A-2 BATT ASMBLY D (FARR CC 4)	1,100.000	Each/HR	STORAGE BATTERIES
141	IND HEATSEAL BOOTH (5)			
143	IND GRIDCASTING (SCIEN #3)	120.000	Each/HR	BATTERY CELLS
144A	IND LEAD OXIDE STORAGE SILOS (6) (BIN VENTS)			
146	IND MIX (SCIEN #2) & PASTE (CARB #1)	120.000	Each/HR	BATTERY CELLS
147	IND BATT ASSY/DRY CHARGE/FORM SUPP (SCIEN #4)	120.000	Each/HR	BATTERY CELLS
148	IND BATT ASSEMBLY (SCIEN #5)	120.000	Each/HR	BATTERY CELLS
149	IND FORMING ROOM & WET CHARGE (4 MIST ELIM)	120.000	Each/HR	BATTERY CELLS
150	IND BATTERY BOOST (4 MIST ELIM)	120.000	Each/HR	BATTERY CELLS
151	A-3 PASTE MIXING (SCIENTIFIC FC #6)	500.000	Each/HR	STORAGE BATTERIES
152	A-3 BATTERY ASSEMBLY (SCIENTIFIC CC #1)	500.000	Each/HR	STORAGE BATTERIES
153	A-3 COS & ENVELOPE A (SCIENTIFIC FC #2)	500.000	Each/HR	STORAGE BATTERIES
154	A-3 LEAD OXIDE STORAGE SILOS (3) (BIN VENTS)	27.300	Tons/HR	LEAD OXIDE
156	A-3 GRIDCAST (SCIENTIFIC FC #6)	500.000	Each/HR	STORAGE BATTERIES
156A	A-3 CONCAST (SCIEN FC 6)	500.000	Each/HR	STORAGE BATTERIES

**SECTION A. Site Inventory List**

Source ID	Source Name	Capacity/Throughput		Fuel/Material
157	A-3 COS & ENVELOPE B (SCIENTIFIC FC #3)	500.000	Each/HR	STORAGE BATTERIES
158	A-3 COS & ENVELOPE D (SCIENTIFIC FC #4)	500.000	Each/HR	STORAGE BATTERIES
159	A-3 COS & STACKING C (SCIENTIFIC FC #5)	500.000	Each/HR	STORAGE BATTERIES
160	LEAD OXIDE MILL 5	2,600.000	Lbs/HR	LEAD OXIDE
		750.000	CF/HR	Natural Gas
161	LEAD OXIDE MILL 6	2,600.000	Lbs/HR	LEAD OXIDE
		750.000	CF/HR	Natural Gas
162	LEAD OXIDE MILL 7	2,600.000	Lbs/HR	LEAD OXIDE
		750.000	CF/HR	Natural Gas
163	LEAD OXIDE MILL 8	2,600.000	Lbs/HR	LEAD OXIDE
		750.000	CF/HR	Natural Gas
169	LEAD OXIDE MILL 9	2,600.000	Lbs/HR	LEAD OXIDE
		750.000	CF/HR	Natural Gas
170	LEAD OXIDE MILL 10	2,600.000	Lbs/HR	LEAD OXIDE
		750.000	CF/HR	Natural Gas
179	S-1 BATTERY ASSEMBLY (SCIENTIFIC FC #6)			
181	S-1 BATTERY ASSEMBLY & DRY CHARGE (SCIENTIFIC FC #3)	300.000	Each/HR	STORAGE BATTERIES
182	S-1 GRIDCAST (SCIENTIFIC FC #1)	300.000	Each/HR	STORAGE BATTERIES
182A	S-1 CONCAST (SCIENTIFIC FC #1)	300.000	Each/HR	STORAGE BATTERIES
183	S-1 GROUP ASSEMBLY (SCIENTIFIC FC #2)	300.000	Each/HR	STORAGE BATTERIES
184	S-1 MIXING (SCIENTIFIC FC #1) & PASTING (SCIENTIFIC FC #4)	300.000	Each/HR	STORAGE BATTERIES
185	S-1 LEAD OXIDE STORAGE SILOS (3) (BIN VENTS)	15.000	Tons/HR	LEAD OXIDE
186	S-1 BATTERY ACTTN/BOOSTIN (5 MIST ELIM)	300.000	Each/HR	STORAGE BATTERIES
187	S-1 BATT FORMATION (10 MIST ELIM)	300.000	Each/HR	STORAGE BATTERIES
188	S-1 UNIGY & GEL BATT ASSEM (SCIENTIFIC FC #5)	300.000	Each/HR	STORAGE BATTERIES
189	S-1 GROUP ASSEMBLY (SCIENTIFIC FC #4)	300.000	Each/HR	STORAGE BATTERIES
191	A-3- BATTERY FORMATION (9 MIST ELIM)	500.000	Each/HR	STORAGE BATTERIES
191A	A-3 BATTERY FORMATION HEATING			
192	A-1 BURN & STACK (SCIENTIFIC FC 5)	200.000	Each/HR	STORAGE BATTERIES
193	A-2 GROUP ASSEMBLY 1 (SCIENTIFIC FC 5)	1,100.000	Each/HR	STORAGE BATTERIES
194	A-2 GROUP ASSEMBLY 2 (SCIENTIFIC FC 6)	1,100.000	Each/HR	STORAGE BATTERIES
195	A-2 GROUP ASSEMBLY 3 (SCIENTIFIC FC 7)	1,100.000	Each/HR	STORAGE BATTERIES
196	LEAD OXIDE MILL 11	2,600.000	Lbs/HR	LEAD OXIDE
		750.000	CF/HR	Natural Gas
197	LEAD OXIDE MILL 12	2,600.000	Lbs/HR	LEAD OXIDE
		750.000	CF/HR	Natural Gas
198	LEAD OXIDE MILL 13	2,600.000	Lbs/HR	LEAD OXIDE
		750.000	CF/HR	Natural Gas
199	LEAD OXIDE MILL 14	2,600.000	Lbs/HR	LEAD OXIDE
		750.000	CF/HR	Natural Gas

**SECTION A. Site Inventory List**

Source ID	Source Name	Capacity/Throughput		Fuel/Material
203	LEAD OXIDE MILL 15	2,600.000	Lbs/HR	LEAD OXIDE
		750.000	CF/HR	Natural Gas
204	LEAD OXIDE MILL 16	2,600.000	Lbs/HR	LEAD OXIDE
		750.000	CF/HR	Natural Gas
205	LEAD OXIDE MILL 17	2,600.000	Lbs/HR	LEAD OXIDE
		750.000	CF/HR	Natural Gas
206	LEAD OXIDE MILL 18	2,600.000	Lbs/HR	LEAD OXIDE
		750.000	CF/HR	Natural Gas
207	LEAD OXIDE MILL 19	2,600.000	Lbs/HR	LEAD OXIDE
		750.000	CF/HR	Natural Gas
208	LEAD OXIDE MILL 20	2,600.000	Lbs/HR	LEAD OXIDE
		750.000	CF/HR	Natural Gas
210	WTP SALT DRYER	0.961	MMBTU/HR	
		961.000	CF/HR	Natural Gas
		1,953.000	Lbs/HR	SALT (WET)
211	WTP SALT TRUCK LOADOUT OPERATION	1,953.000	Lbs/HR	SALT (WET)
212	WTP SALT STORAGE SILOS	30,000.000	Lbs/HR	SALT (DRY)
213	MISCELLANEOUS CHEM			
214	SPRAY BOOTH- CENTRAL MAINT PAINT BOOTH			
221	LEAD OXIDE MILL NO. 21	2,600.000	Lbs/HR	LEAD OXIDE
		750.000	CF/HR	Natural Gas
222	LEAD OXIDE MILL NO. 22	2,600.000	Lbs/HR	LEAD OXIDE
		750.000	CF/HR	Natural Gas
223	LEAD OXIDE MILL NO. 23	2,600.000	Lbs/HR	LEAD OXIDE
		750.000	CF/HR	Natural Gas
224	LEAD OXIDE MILL NO. 24	2,600.000	Lbs/HR	LEAD OXIDE
		750.000	CF/HR	Natural Gas
225	LEAD OXIDE MILL NO. 25	2,600.000	Lbs/HR	LEAD OXIDE
		750.000	CF/HR	Natural Gas
226	LEAD OXIDE MILL NO. 26	2,600.000	Lbs/HR	LEAD OXIDE
		750.000	CF/HR	Natural Gas
227	LEAD OXIDE MILL NO. 27	2,600.000	Lbs/HR	LEAD OXIDE
		750.000	CF/HR	Natural Gas
228	LEAD OXIDE MILL NO. 28	2,600.000	Lbs/HR	LEAD OXIDE
		750.000	CF/HR	Natural Gas
229	LEAD OXIDE MILL NO. 29	0.750	MMBTU/HR	
230	LEAD OXIDE MILL NO. 30	0.750	MMBTU/HR	
231	LEAD OXIDE MILL NO. 31	0.750	MMBTU/HR	
232	LEAD OXIDE MILL NO. 32	0.750	MMBTU/HR	
233	LEAD OXIDE MILL NO. 33	0.750	MMBTU/HR	
234	LEAD OXIDE MILL NO. 34	0.750	MMBTU/HR	
235	LEAD OXIDE MILL NO. 35 (A-4)	2,600.000	Lbs/HR	LEAD OXIDE

**SECTION A. Site Inventory List**

Source ID	Source Name	Capacity/Throughput	Fuel/Material
		500.000 CF/HR	Natural Gas
		8.300 Gal/HR	Propane
236	LEAD OXIDE MILL NO. 36 (A-4)	2,600.000 Lbs/HR	LEAD OXIDE
		500.000 CF/HR	Natural Gas
		8.300 Gal/HR	Propane
237	LEAD OXIDE MILL NO. 37 (A-4)	2,600.000 Lbs/HR	LEAD OXIDE
		500.000 CF/HR	Natural Gas
		8.300 Gal/HR	Propane
238	LEAD OXIDE MILL NO. 38 (A-4)	2,600.000 Lbs/HR	LEAD OXIDE
		500.000 CF/HR	Natural Gas
		8.300 Gal/HR	Propane
239	LEAD OXIDE MILL NO. 39 (A-4)	2,600.000 Lbs/HR	LEAD OXIDE
		500.000 CF/HR	Natural Gas
		8.300 Gal/HR	Propane
240	LEAD OXIDE MILL NO. 40 (A-4)	2,600.000 Lbs/HR	LEAD OXIDE
		500.000 CF/HR	Natural Gas
		8.300 Gal/HR	Propane
301	S-1A BATT ASSEMBLY ANNEX (SCIENTIFIC FC 6)	300.000 Each/HR	STORAGE BATTERIES
302	S-1A FORMATION ANNEX (3 MIST ELIM)	300.000 Each/HR	STORAGE BATTERIES
303	S-1 SILICON DIOXIDE SILO (1 BIN VENT)		
401	A-4 LEAD OXIDE STORAGE SILOS (9) (BIN VENTS)		
402	A-4 MIXING (SCIEN #6) & PASTING (SCIEN #1)	4.800 MMBTU/HR	
403	A-4 GRIDCASTING (SCIEN FC #2)	10.000 MMBTU/HR	
404	A-4 CONCASTING (SCIEN FC #2)	2.000 MMBTU/HR	
405	A-4 THREE-PROCESS-OPR (FC #3 & #4 & #7)	0.800 MMBTU/HR	
406	A-4 BATTERY FORMATION (9) (MIST ELIM)		
407	A-4 BATT ASSEMBLY LINES (SCIEN FC #5)		
502	A-2 SMALL PARTS CASTING (FUGITIVE/UNCONTROL)	1,100.000 Each/HR	STORAGE BATTERIES
503	A-2 RED LEAD OXIDE STORAGE SILO (BIN VENT)	10.000 Tons/HR	LEAD OXIDE RED
504	A-1 SMALL PARTS CASTING (FUGITIVE/UNCONTROL)	200.000 Each/HR	STORAGE BATTERIES
505	A-3 SMALL PARTS CASTING (FUGITIVE/UNCONTROL)	500.000 Each/HR	STORAGE BATTERIES
506	SMALL PARTS CASTING & HYDRACAST	120.000 Each/HR	BATTERYCELLS
507	S-1 SMALL PART CASTING (FUGITIVE/UNCONT)	300.000 Each/HR	STORAGE BATTERIES
508	A-2 COS/ENVELOPE/CONCAST (SCIEN 10)		
511	A-1 HEAT SEAL BOOTHS #1-4		
512	A-2 HEAT SEAL BOOTHS #1-9		
513	A-3 HEAT SEAL BOOTHS #1 - 3		
514	S-1 HEAT SEAL BOOTHS #1-3		
515	MOLDING LID SEAL BOOTHS 1-13: FIBER BEDS OR EQIV		

**SECTION A. Site Inventory List**

Source ID	Source Name	Capacity/Throughput	Fuel/Material
516	A-4 HEAT & LID SEAL BOOTHS 1 - 14: FIBER BEDS OR EQUIV CTRL		
517	SMELTER ANNEX LID SEALER BOOTHS #1-24		
518	IND HEAT SEAL BOOTHS #1 & #2		
601A	EMERGENCY ENGINES PRE-2006		
601B	EMERGENCY SI ENGINES POST-2006		
601C	EMERGENCY CI ENGINES POST-2006		
601D	NON-EMERGENCY GENERATORS PRE-2006		
602	COLD CLEANERS		
603	SMALL PARTS COATING OPERATION		
604	IND BATTERY TOUCH-UP OPERATION		
604B	IND BATTERY TOUCH-UP OPERATION (POST-2012)		
605	BATTERY FINISHING		
608	GASOLINE AND DIESEL HANDLING		
699	5D SOURCES		
700	MISC COMBUSTION SOURCES (NOT 5D, NOT EMERGENCY GEN)		
718	IND BATT FORMATION FOR A-3 (6 MIST ELIM)		
719	IND BATT FINISHING FOR A-3 (2 LINES)		
720	IND ULTRA BATTERY OPERATIONS		
721	IND UNIGY II THREE-PROCESS-OPR		
722	IND UNIGY II GRIDCASTING OPR		
724	IND AUTO COS #3		
725	IND AUTO HEAT SEAL		
726	IND AUTO BATTERY FINISHING		
727	IND AUTO BAT W/BATH FORM (2 MIST ELIMN)		
728	EQUIPMENT DECONSTRUCTION BUILDING		
C01	FABRIC COLLECTOR: A-1 DRY CHARGE/GRIDCAST/BATT ASSEM (SC #6)		
C01A	HEPA: A-1 DRY CHARGE/GRIDCAST/BATT ASSEM (SCIEN #6)		
C08	FABRIC COLLECTOR: A-1 MIXING/PASTING (SCIEN #1) 384		
C08A	HEPA: A-1 MIXING/PASTING (SCIEN #1)		
C09	FABRIC COLLECTOR: A-1 DRY CHARGE (SCIEN #7)		
C09A	HEPA: A-1 DRY CHARGE (SCIEN #7)		
C12	CYCLONE: OXIDE MILL 1		
C13	FABRIC COLLECTOR: OXIDE MILL 1		
C131	FABRIC CLTR: A-2 MIXING & PASTING (SCIEN #9)		
C131A	HEPA: A-2 MIXING & PASTING (SCIEN #9)		
C132	FABRIC COLLECTOR: A-2 COS/ENVEL/PUNCHCAST (SCIEN FC #1)		
C132A	HEPA FILTER: A-2 COS/ENVEL/PUNCHCAST (SCIEN FC #1)		

**SECTION A. Site Inventory List**

Source ID	Source Name	Capacity/Throughput	Fuel/Material
C134	FABRIC FILTER: A-2 COS/ENVELOPER (SCIEN FC #11)		
C134A	HEPA FILTER: A-2 COS/ENVELOPER		
C135	BIN VENTS (3): IND LEAD OXIDE RECEIVE TANK		
C135A	HEPA FILTER (3): IND LEAD OXIDE RECEIVE TANK		
C13A	HEPA: OXIDE MILL NO. 1 (OXIDE)		
C14	CYCLONE: OXIDE MILL 2		
C141	FIBER BEDS (5): IND HEATSEAL (BATT ASSEM)		
C141A	HEPA (5): FIBER BEDS IND HEATSEAL		
C147	FABRIC: IND BATT ASSY/DRY CHARGE (SCIEN #4)		
C147A	HEPA: IND BATT ASSY/DRY CHARGE (SCIEN #4)		
C148	FABRIC: IND BATTERY ASSEMBLY (SCIEN #5)		
C148A	HEPA: IND BATTERY ASSEMBLY (SCIEN #5)		
C15	FABRIC COLLECTOR: OXIDE MILL 2		
C151	FABRIC COLLECTOR: A-3 PASTING/MIX/CASTING (SCIEN #6)		
C151A	HEPA: A-3 MIX/PASTE/CASTING (SCIEN #6)		
C15A	HEPA: OXIDE MILL NO.2 (OXIDE)		
C17	FABRIC CLTR: A-2 COS&ENVEL/CONCAST (CARB 1)		
C18	FABRIC CLTR: A-2 ASSEMBLY (SCIENTIFIC 8)		
C181	FABRIC COLLECTOR: S-1 DRY CHARGE/EASTDOCK (SCIEN FC #3)		
C181A	HEPA: S-1 DRY CHARGE/EASTDOCK (SCIEN FC #3)		
C18A	HEPA: A-2 ASSEMBLY (SCIENTIFIC 8)		
C19	BIN VENTS(7): A-2 OXIDE BINS		
C19A	HEPA(7): A-2 LEAD OXIDE BINS		
C203	FABRIC COLLECTOR: OXIDE MILL 15		
C203A	CYCLONE: OXIDE MILL NO. 15		
C203B	HEPA: OXIDE MILL NO. 15		
C204	FABRIC COLLECTOR: OXIDE MILL 16		
C204A	CYCLONE: OXIDE MILL NO. 16		
C204B	HEPA: OXIDE MILL NO. 16		
C205A	CYCLONE: OXIDE MILL 17		
C205B	FABRIC COLLECTOR: OXIDE MILL 17		
C205C	HEPA: OXIDE MILL 17		
C206A	CYCLONE: OXIDE MILL 18		
C206B	FABRIC COLLECTOR: OXIDE MILL 18		
C206C	HEPA: OXIDE MILL 18		
C207A	CYCLONE: LEAD OXIDE MILL 19		
C207B	FABRIC COLLECTOR: LEAD OXIDE MILL 19		
C207C	HEPA: OXIDE MILL 19		
C208A	CYCLONE: LEAD OXIDE MILL 20		

**SECTION A. Site Inventory List**

Source ID	Source Name	Capacity/Throughput	Fuel/Material
C208B	FABRIC COLLECTOR: OXIDE MILL 20		
C208C	HEPA: OXIDE MILL 20		
C21	SCRUBBERS: A-2 BATTERY FORMATION		
C210	FABRIC COLLECTOR: WTP SALT DRYER (SLY)		
C211	FABRIC COLLECTOR: WTP SALT TRUCK LOADOUT (CYCLONAIRE)		
C212	BIN VENT: WTP SALT SILO (CYCLONAIRE)		
C214	DRY FILTERS: CENTRAL MAINT PAINT BOOTH		
C22	FABRIC COLLECTOR: A-2 BATT ASS/GRIDCAST/PASTE (SCIEN 2)		
C221A	CYCLONE: MILL NO. 21		
C221B	FABRIC COLLECTOR: MILL NO. 21		
C221C	HEPA: MILL NO. 21		
C222A	CYCLONE: MILL NO. 22		
C222B	FABRIC COLLECTOR: MILL NO. 22		
C222C	HEPA: MILL NO. 22		
C223A	CYCLONE: OXIDE MILL NO. 23		
C223B	FABRIC COLLECTOR: OXIDE MILL NO. 23		
C223C	HEPA: OXIDE MILL NO. 23		
C224A	CYCLONE: OXIDE MILL NO. 24		
C224B	FABRIC COLLECTOR: OXIDE MILL NO. 24		
C224C	HEPA: OXIDE MILL NO. 24		
C225A	CYCLONE: OXIDE MILL NO. 25		
C225B	FABRIC COLLECTOR: OXIDE MILL NO. 25		
C225C	HEPA: OXIDE MILL NO. 25		
C226A	CYCLONE: OXIDE MILL NO.26		
C226B	FABRIC COLLECTOR: OXIDE MILL NO. 26		
C226C	HEPA: OXIDE MILL NO. 26		
C227A	CYCLONE: OXIDE MILL NO. 27		
C227B	FABRIC COLLECTOR: OXIDE MILL NO. 27		
C227C	HEPA: OXIDE MILL NO. 27		
C228A	CYCLONE: OXIDE MILL NO. 28		
C228B	FABRIC COLLECTOR: OXIDE MILL NO. 28		
C228C	HEPA: OXIDE MILL NO. 28		
C229A	CYCLONE: OXIDE MILL NO 29		
C229B	FABRIC COLLECTOR: OXIDE MILL NO. 29		
C229C	HEPA: OXIDE MILL NO. 29		
C22A	HEPA: A-2 BATT ASSEMBLY/GRIDCAST/PASTE		
C230A	CYCLONE: OXIDE MILL NO. 30		
C230B	FABRIC COLLECTOR: OXIDE MILL NO. 30		
C230C	HEPA: OXIDE MILL NO. 30		

**SECTION A. Site Inventory List**

Source ID	Source Name	Capacity/Throughput	Fuel/Material
C231A	CYCLONE: OXIDE MILL NO. 31		
C231B	FABRIC COLLECTOR: OXIDE MILL NO. 31		
C231C	HEPA: OXIDE MILL NO. 31		
C232A	CYCLONE: OXIDE MILL NO. 32		
C232B	FABRIC COLLECTOR: OXIDE MILL NO. 32		
C232C	HEPA: OXIDE MILL NO. 32		
C233A	CYCLONE: OXIDE MILL NO. 33		
C233B	FABRIC COLLECTOR: OXIDE MILL NO. 33		
C233C	HEPA: OXIDE MILL NO. 33		
C234A	CYCLONE: OXIDE MILL NO. 34		
C234B	FABRIC COLLECTOR: OXIDE MILL NO. 34		
C234C	HEPA: OXIDE MILL NO. 34		
C235A	CYCLONE: OXIDE MILL NO. 35 (A-4 OXIDE)		
C235B	FABRIC COLLECTOR: OXIDE MILL NO. 35 (A-4 OXIDE)		
C235C	HEPA: OXIDE MILL NO. 35 (A-4 OXIDE)		
C236A	CYCLONE: OXIDE MILL NO. 36 (A-4 OXIDE)		
C236B	FABRIC COLLECTOR: OXIDE MILL NO. 36 (A-4)		
C236C	HEPA: OXIDE MILL NO. 36 (A-4)		
C237A	CYCLONE: OXIDE MILL NO. 37 (A-4 OXIDE)		
C237B	FABRIC COLLECTOR: OXIDE MILL NO. 37 (A-4 OXIDE)		
C237C	HEPA: OXIDE MILL NO. 37 (A-4 OXIDE)		
C238A	CYCLONE: OXIDE MILL NO. 38 (A-4 OXIDE)		
C238B	FABRIC COLLECTOR: OXIDE MILL NO. 38 (A-4 OXIDE)		
C238C	HEPA: OXIDE MILL NO. 38 (A-4 OXIDE)		
C239A	CYCLONE: OXIDE MILL NO. 39 (A-4 OXIDE)		
C239B	FABRIC COLLECTOR: OXIDE MILL NO. 39 (A-4 OXIDE)		
C239C	HEPA: OXIDE MILL NO. 39 (A-4 OXIDE)		
C24	CYCLONE: OXIDE MILL 3		
C240A	CYCLONE: OXIDE MILL NO. 40 (A-4 OXIDE)		
C240B	FABRIC COLLECTOR: OXIDE MILL NO. 40 (A-4 OXIDE)		
C240C	HEPA: OXIDE MILL NO. 40 (A-4 OXIDE)		
C25	FABRIC COLLECTOR: OXIDE MILL 3		
C25A	HEPA: OXIDE MILL NO. 3 (OXIDE)		
C26A	BIN VENTS (6): IND LEAD OXIDE SILOS		
C26AA	HEPA (6): IND LEAD OXIDE SILOS		
C28	FABRIC COLLECTOR: IND MIXING (SCIEN #2)		
C28A	HEPA: IND MIXING (SCIEN #2)		
C29	FABRIC: IND DRY PASTING (CARB #1)		

**SECTION A. Site Inventory List**

Source ID	Source Name	Capacity/Throughput	Fuel/Material
C29A	HEPA: IND DRY PASTING (CARB #1)		
C30	FABRIC COLLECTOR: IND BATT ASSEMBLE (CARB E)		
C301	FABRIC COLLECTOR: S-1A BATT ASSEMBLY (SCIEN FC 6)		
C301A	HEPA: S-1A BATT ASSEMBLY (SCIEN FC 6)		
C302	MIST ELIMS (3): S-1A FORMATION		
C303	BIN VENT: S-1 SILICON DIOXIDE SILO		
C30A	HEPA: IND BATT ASSEMBLY (CARB E)		
C31	MIST ELIMS (4): IND FORMATION (TRIMER)		
C33	MIST ELIMS (4): IND BATT BOOST (TRIMER)		
C34	CYCLONE: OXIDE MILL 4		
C35	FABRIC COLLECTOR: OXIDE MILL 4		
C35A	HEPA: OXIDE MILL NO. 4 (OXIDE)		
C36	BIN VENT: A-1 #1 OXIDE BIN		
C36A	BIN VENTS: A-1 LEAD OXIDE BINS (2)		
C36B	HEPA FILTER: A-1 LEAD OXIDE SILOS		
C38	CART COLLECTOR: A-2 BATT ASSEMBLY (FARR 3)		
C38A	HEPA: A-2 ASSEMBLY (FARR 3) & RED LEAD OXIDE SILO		
C39	FABRIC: IND GRID/CONCAST (SCIEN #3)		
C39A	HEPA: IND GRID/CONCAST (SCIEN #3)		
C40	FABRIC: IND WET PASTING (SCIEN #2)		
C401	BIN VENTS: A-4 LEAD OXIDE STORAGE SILOS (ASS)		
C401A	HEPA: A-4 LEAD OXIDE STORAGE SILOS (ASS)		
C402	FABRIC COLLECTOR: A-4 PASTING OP (SCIEN FC #1)		
C402A	HEPA: A-4 PASTING OPERATION (SCIEN FC #1)		
C403	FABRIC COLLECTOR: A-4 GRID/CONCAST (SCIEN FC #2)		
C403A	HEPA: A-4 GRID/CONCASTING (SCIEN FC #2)		
C405	FABRIC COLLECTOR: A-4 THREE-PROCESS-OPR (SCIEN FC #3)		
C405A	HEPA: A-4 THREE-PROCESS-OPR (SCIEN FC #3)		
C406	ELIMINATORS (9): A-4 BATTERY FORMATION		
C407	FABRIC COLLECTOR: A-4 BATT ASSEMBLY (SCIEN FC #5)		
C407A	HEPA: A-4 BATT ASSEMBLY (SCIEN FC #5)		
C408	FABRIC COLLECTOR: A-4 PASTING OP (SCIEN FC #6)		
C408A	HEPA: A-4 PASTING OPERATION (SCIEN FC #6)		
C40A	HEPA: IND WET PASTING (SCIEN #2)		
C41	CART COLLECTOR: A-1 PASTING/DRY CHARGE/ASSEMBLY (FARR 4)		
C415	FABRIC COLLECTOR: A-4 THREE-PROCESS-OPR (SCIEN FC #4)		

**SECTION A. Site Inventory List**

Source ID	Source Name	Capacity/Throughput	Fuel/Material
C415A	HEPA: A-4 THREE-PROCESS-OPR (SCIEN FC #4)		
C416	FABRIC COLLECTOR: A-4 THREE-PROCESS-OPR (FC #7)		
C416A	HEPA: A-4 THREE-PROCESS-OPR (FC #7)		
C41A	HEPA: A-1 PASTING/DRY CHARGE/ASSEMBLY (FARR CC #4)		
C503	FABRIC COLLECTOR: A-2 RED LEAD OXIDE SILO		
C506	FABRIC COLLECTOR: SA PARTS CASTING		
C506A	HEPA: SA PARTS CASTING		
C508	FABRIC COLLECTOR: A-2 COS/ENVELOP/GRIDCAST (SCIEN #10)		
C508A	HEPA: A-2 COS/ENVELOP/GRIDCASTING (SCIEN #10)		
C509	FABRIC FILTER: A-2 STRIPCAST MACHINE (SCIEN 8)		
C509A	HEPA: A-2 STRIPCAST MACHINE (SCIEN 8)		
C511	FIBER BEDS OR APPROVED EQUIV: A-1 HEAT SEAL BOOTHS 1-4		
C511A	HEPA: A-1 HEAT SEAL BOOTHS #1-4		
C512	FIBER BED: A-2 HEAT SEAL BOOTHS 1 - 9		
C512A	HEPA: A-2 HEAT SEAL BOOTHS #1-9		
C513	FIBER BED: A-3 HEAT SEAL BOOTHS #1-3		
C513A	HEPA: A-3 HEAT SEAL BOOTHS #1-3		
C514	FIBER BED: S-1 HEAT SEAL BOOTHS #1-3		
C514A	HEPA: S-1 HEAT SEAL BOOTHS #1-3		
C515	FIBER BEDS OR EQUIV: MOLDING LID SEAL BOOTHS #1-13		
C515A	HEPA: MOLDING LID SEAL BOOTHS #1-13		
C516	FIBER BEDS OR APPROVED EQUIV: A-4 HEAT SEAL (BATT ASSEM)		
C516A	HEPA: A-4 HEAT SEAL BOOTHS		
C517	SA LID SEAL BOOTHS #1-24: FIBER BEDS OR EQUIVALENT		
C517A	HEPA: SMELTER ANNEX LID SEALER BOOTHS #1-24:		
C518	FIBER BEDS OR APPROVED EQUIV: IND HEAT SEAL		
C52	CART COLLECTOR: A-3 BATT ASSEMBLY (SCIEN 1)		
C52A	HEPA: A-3 BATT ASSEMBLY (SCIEN #1)		
C53	FABRIC COLLECTOR: A-3 COS/ENVELOP (SCIEN 2)		
C53A	HEPA: A-3 COS/ENVELOPE (SCIEN #2)		
C54	BIN VENTS: A-3 LEAD OXIDE BINS		
C54A	HEPA FILTER: A-3 LEAD OXIDE SILOS		
C58	CART COLLECTOR: A-2 BATT ASSEMBLY (FARR 4)		
C58A	HEPA: A-2 BATT ASSEMBLY (FARR#4)		
C59	FABRIC COLLECTOR: A-3 COS/ENVELOPE (SCIEN 3)		
C59A	HEPA: COS/ENVELOPING (SCIENTIFIC #3)		

**SECTION A. Site Inventory List**

Source ID	Source Name	Capacity/Throughput	Fuel/Material
C60	FABRIC COLLECTOR: OXIDE MILL 5		
C603A	DRY FILTERS: SMALL PARTS COATING		
C604	DRY FILTERS: IND BATT TOUCH-UP		
C60A	CYCLONE: OXIDE MILL NO. 5		
C60B	HEPA: OXIDE MILL NO. 5 (OXIDE)		
C61	FABRIC COLLECTOR: OXIDE MILL 6		
C61A	CYCLONE: OXIDE MILL NO. 6		
C61B	HEPA: OXIDE MILL NO. 6 (OXIDE)		
C62	FABRIC COLLECTOR: OXIDE MILL 7		
C62A	CYCLONE: OXIDE MILL NO. 7		
C62B	HEPA: OXIDE MILL NO. 7 (OXIDE)		
C63	FABRIC COLLECTOR: OXIDE MILL 8		
C63A	CYCLONE: OXIDE MILL NO. 8		
C63B	HEPA: OXIDE MILL NO. 8 (OXIDE)		
C64	FABRIC COLLECTOR: A-3 COS/STACKING (SCIEN 5)		
C64A	HEPA: A-3 COS & STACKING (SCIENTIFIC #5)		
C69	FABRIC COLLECTOR: OXIDE MILL 9		
C69A	CYCLONE: OXIDE MILL NO. 9		
C69B	HEPA: OXIDE MILL NO. 9		
C70	FABRIC COLLECTOR: OXIDE MILL 10		
C70A	CYCLONE: OXIDE MILL NO. 10		
C70B	HEPA: OXIDE MILL NO. 10 (OXIDE)		
C718	MIST ELIMS (6): IND FORMATION FOR A-3		
C720	FABRIC CLTR: IND ULTRA BATTERY		
C720A	HEPA: IND ULTRA BATTERY		
C721	FABRIC CLTR: IND UNIGY II THREE-PROCESS-OPR		
C721A	HEPA: IND UNIGY II THREE-PROCESS-OPR		
C722	FABRIC CLTR: IND UNIGY II GRIDCASTING OPR		
C722A	HEPA: IND UNIGY II GRIDCASTING OPR		
C724	FABRIC COLLECTOR: IND AUTO COS #3		
C724A	HEPA: IND AUTO COS #3		
C725	IND AUTO HEAT SEAL: FIBER BEDS OR APPROVED EQUIV		
C727	MIST ELIMN (2): IND AUTO W/BATH FORM		
C728	FABRIC FILTER: EQUIPMENT DECONSTRUCTION BLDG		
C728A	HEPA: EQUIPMENT DECONSTRUCTION BUILDING		
C78	FABRIC COLLECTOR: A-3 BATT ASSEMPASTE (SCIEN 4)608		
C78A	HEPA: A-3 BATT ASSEMBLY/PASTE (SCIEN #4)		
C79	FABRIC COLLECTOR: S-1 BATTERY ASSEMBLY		
C79A	HEPA: S-1 BATTERY ASSEMBLY		

**SECTION A. Site Inventory List**

Source ID	Source Name	Capacity/Throughput	Fuel/Material
C83	FABRIC COLLECTOR: S-1 GROUP ASSEMB/CONCAST (SCIEN #2)		
C83A	HEPA: S-1 GROUP ASSEMBLY/CONCAST (SCIENCE 608)		
C841	FABRIC CLTR: S-1 ASSMBL/GRID CAST/CONCAST/PASTE (SCI #1)		
C841A	HEPA: ASSMBL/GRISCAST/CONCAST/PASTE (SCI #1)		
C85	BIN VENTS (3): S-1 LEAD OXIDE SILOS		
C85A	HEPA FILTER: S-1 LEAD OXIDE SILOS		
C86	MIST ELIMS (3): S-1 BATTERY ACTIVATION		
C87	MIST ELIMS (12): S-1 PLATE FORMATION		
C88	FABRIC COLLECTOR: S-1 UNIGY/GEL ASSEMBLY (SCIEN 736)		
C88A	HEPA: S-1 UNIGY/GEL ASSEMBLY (SCIENCE 736)		
C89	FABRIC COLLECTOR: S-1 ASSEMBLY (SCIEN #4)		
C89A	HEPA: S-1 ASSEMBLY (SCIEN #4)		
C91	MIST ELIMS (9): A-3 FORMATION		
C92	FABRIC COLLECTOR: A-1 BURN & STACK/GRIDCAST (SCIEN 5)		
C92A	HEPA: A-1 STACK & BURN/GRIDCAST		
C93	FABRIC COLLECTOR: A-2 GRP ASSEMBLY 1 (SCIENTIFIC 5)		
C93A	HEPA: A-2 GRP ASS #1 (SCIEN #5)		
C94	FABRIC COLLECTOR: A-2 GA 2/GRIDCAST/PASTE (SCIEN FC 6)		
C94A	HEPA: A-2 GR ASSEM #2/GRIDCAST/PASTE (SCIEN #6)		
C95	FABRIC COLLECTOR: A-2 GRP ASSEMBLY 3 (SCIENTIFIC 7)		
C95A	HEPA: A-2 GRP ASSEMBLY 3 (SCIEN 7)		
C96	FABRIC COLLECTOR: OXIDE MILL 11		
C96A	CYCLONE: OXIDE MILL 11		
C96B	HEPA: OXIDE MILL 11		
C97	FABRIC COLLECTOR: OXIDE MILL 12		
C97A	CYCLONE: OXIDE MILL NO. 12		
C97B	HEPA: OXIDE MILL NO. 12		
C98	FABRIC COLLECTOR: OXIDE MILL 13		
C98A	CYCLONE: OXIDE MILL NO. 13		
C98B	HEPA: OXIDE MILL NO. 13		
C99	FABRIC COLLECTOR: OXIDE MILL 14		
C99A	CYCLONE: OXIDE MILL NO. 14		
C99B	HEPA: OXIDE MILL NO. 14		
FM001	PROPANE TANK FARM		
FM002	NATURAL GAS PIPELINE		
FM003	DIESEL TANK		

**SECTION A. Site Inventory List**

Source ID	Source Name	Capacity/Throughput	Fuel/Material
S01	STACK: DRY CHARGE/GRIDCAST/BATT ASSEM (SCIEN #6)		
S07	STACK: A-1 MIXING & PASTING (SCIEN #1)		
S08	STACK: A-1 DRY CHARGE (SCIEN #7)		
S11	STACK: OXIDE MILL 1		
S12	STACK: OXIDE MILL 2		
S131	STACK: A-2 MIXING & PASTING (SCIEN #9)		
S132	STACK: COS/ENVEL/PUNCHCAST		
S134	STACK: A-2 COS/ENVELOPER		
S135	STACK (3): IND LEAD OXIDE RECEIVE TANK		
S141	STACKS (5): IND HEATSEAL		
S147	STACK: IND BATT ASSY/DRY CHARGE (SCIEN #4)		
S148	STACK: IND BATTERY ASSEMBLY (SCIEN #5)		
S151	STACK: A-3 PASTING/MIX/CASTING (SCIENTIFIC #6)		
S16	STACK (7): A-2 LEAD OXIDE		
S18	STACKS: A-2 BATTERY FORMATION		
S19	STACK: A-2 ASSBLY/MIX/PASTE/GRIDCAST (SCIEN 2)		
S203	STACK: OXIDE MILL 15		
S204	STACK: OXIDE MILL 16		
S205	STACK: OXIDE MILL 17		
S206	STACK: OXIDE MILL 18		
S207	STACK: OXIDE MILL 19		
S208	STACK: OXIDE MILL 20		
S21	STACK: OXIDE MILL 3		
S210	STACK: WTP SALT DRYER (SLY FC)		
S211	STACK: WTP SALT TRUCK LOADOUT (CYCLONAIRE)		
S212	STACK: WTP SALT STORAGE SILOS (CYCLONAIRE)		
S214	STACK: CENTRAL MAINT PAINT BOOTH		
S221	STACK: OXIDE MILL NO. 21		
S222	STACK: OXIDE MILL NO. 22		
S223	STACK: OXIDE MILL NO. 23		
S224	STACK: OXIDE MILL NO. 24		
S225	STACK: OXIDE MILL NO. 25		
S226	STACK: OXIDE MILL NO. 26		
S227	STACK: OXIDE MILL NO. 27		
S228	STACK: OXIDE MILL NO. 28		
S229	STACK: OXIDE MILL NO. 29		
S22A	STACKS (5): IND LEAD OXIDE SILOS		
S230	STACK: OXIDE MILL NO. 30		
S231	STACK: OXIDE MILL NO. 31		

**SECTION A. Site Inventory List**

Source ID	Source Name	Capacity/Throughput	Fuel/Material
S232	STACK: OXIDE MILL NO.32		
S233	STACK: OXIDE MILL NO. 33		
S234	STACK: OXIDE MILL NO. 34		
S235	STACK: OXIDE MILL NO. 35 (A-4 OXIDE)		
S236	STACK: OXIDE MILL NO. 36 (A-4 OXIDE)		
S237	STACK: OXIDE MILL NO 37 (A-4 OXIDE)		
S238	STACK: OXIDE MILL NO. 38 (A-4 OXIDE)		
S239	STACK: OXIDE MILL NO. 39 (A-4 OXIDE)		
S24	STACK: IND WET PASTING (SCIEN #2)		
S240	STACK: OXIDE MILL NO. 40 (A-4 OXIDE)		
S25	STACK: IND DRY PASTING (CARB #1)		
S27	STACKS (11): IND FORMATION		
S29	STACKS (4): IND BATTERY BOOST		
S30	STACK: OXIDE MILL 4		
S301	STACK: S-1A BATT ASSEMBLY (SCIEN FC 6)		
S302	STACK: S-1A FORMATION		
S303	STACK: S-1 SILICON DIOXIDE SILO		
S32A	STACKS (2): A-1 LEAD OXIDE BINS (VENTS)		
S33	STACK: A-2 ASSEMBLY (FARR 3)		
S35	STACK: A-1 SMALL PARTS CASTING		
S37	STACK: A-1 DRY CHARGE/ASSEMBLY/PASTING (FARR 4)		
S38	STACK: IND GRID/CONCAST (SCIEN #3)		
S40	STACK: A-3 COS & ENVELOPE (SCIEN FC 3)		
S401	STACKS: A-4 LEAD OXIDE STORAGE SILOS (ASS)		
S402	STACK: A-4 PASTING OPERATION (SCIEN FC #1)		
S403	STACK: A-4 GRID/CONCAST (SCIEN FC #2)		
S405	STACK: A-4 THREE-PROCESS-OPR (SCIEN FC #3)		
S406	STACK: A-4 BATTERY FORMATION (ELIM)		
S407	STACK: A-4 BATTERY ASSEMBLY (SCIEN FC #5)		
S408	STACK: A-4 PASTING OPERATION (SCIEN FC #6)		
S415	STACK: A-4 THREE-PROCESS-OPR (SCIEN FC #4)		
S416	STACK: A-4 THREE-PROCESS-OPR (FC #7)		
S502	STACK: A-2 SMALL PARTS CASTING		
S506	STACK: SA PARTS CASTING		
S508	STACK: A-2 COS/ENVELOP/GRIDCASTING (SCIEN #10)		
S509	STACK: A-2 STRIPCAST MACHINE		
S511	STACK: A-1 HEAT SEAL		
S512	STACKS: A-2 HEAT SEAL		
S513	STACKS: A-3 HEAT SEAL		
S514	STACKS: S-1 HEAT SEAL		

**SECTION A. Site Inventory List**

Source ID	Source Name	Capacity/Throughput	Fuel/Material
S515	STACK: MOLDING HEAT SEALING OPS		
S516	STACKS: A-4 HEAT SEALING (BATT ASSEM)		
S517	SMELTER ANNEX LID SEALERS STACKS		
S518	STACK: IND HEAT SEAL		
S52	STACK: A-3 BATT ASSEMBLY (SCIEN FC 1)		
S53	STACK: A-3 COS & ENVELOPE (SCIEN FC 2)		
S54	STACK: A-3 LEAD OXIDE BINS		
S58	STACK: A-2 ASSEMBLY/RED LEAD (FARR 4)		
S59	STACKS: A-3 GRID/SMALL PARTS CASTING		
S59A	STACKS: A3 CONCASTING		
S60	STACK: OXIDE MILL 5		
S601A	STACKS: EMERGENCY ENGINES PRE-2006		
S601B	STACKS: EMERGENCY SI ENGINES POST-2006		
S601C	STACKS: EMERGENCY CI ENGINES POST-2006		
S601D	STACKS: NON-EMERGENCY GENERATORS PRE-2006		
S603	STACK: SMALL PARTS COATING		
S604	STACK: IND BATT TOUCH-UP		
S61	STACK: OXIDE MILL 6		
S62	STACK: OXIDE MILL 7		
S63	STACK: OXIDE MILL 8		
S66	STACK: A-3 STK & COS (SCIEN FC 5)		
S69	STACK: OXIDE MILL 9		
S699	5D SOURCES EXHAUSTS		
S70	STACK: OXIDE MILL 10		
S700	SOURCE 700 EXHAUSTS		
S718	STACKS (6) IND FORMATION FOR A-3		
S720	STACK: IND ULTRA BATTERY		
S721	STACK: IND UNIGY II THREE-PROCESS-OPR		
S722	STACK: IND UNIGY II GRIDCASTING OPR		
S724	STACK: IND AUTO COS #3		
S725	STACK: IND AUTO HEAT SEAL		
S727	STACK: IND AUTO W/BATH FORM		
S728	STACK: EQUIPMENT DECONSTRUCTION BUILDING		
S78	STACK: A-3 ASSEMBLY/PASTE (SCIEN 4)		
S79	STACK: S-1 ASSEMBLY (SCIEN FC 6)		
S81	STACK: S-1 ASSEMBLY/DRY CHARGE (SCIENTIFIC)		
S82E	STACK: S-1 GRID/SMALL PARTS CASTING EAST ST		
S83	STACK: S-1 GROUP ASSEMBLY/CONCAST (SCIEN #2)		
S841	STACK: ASSMBL/GRIDCAST/CONCAST/PASTE (SCI #1)		

**SECTION A. Site Inventory List**

Source ID	Source Name	Capacity/Throughput	Fuel/Material
S85	STACKS(3): S-1 LEAD OXIDE BINS		
S86	STACKS(3): S-1 BATT ACTIVATION		
S87	STACKS(6): S-1 FORMATION		
S88	STACK: S-1 UNIGY/GEL ASSBLY (SCIEN 736)		
S89E	STACK: S-1 ASSEMBLY EAST ST (SCIENT #4)		
S89W	STACK: S-1 ASSEMBLY WEST ST (SCIENT 736)		
S91	STACKS (9): A-3 FORMATION		
S91A	STACKS: A-3 BATTERY FORMATION HEATING		
S92	STACK: A-1 STK & BURN/GRIDCAST (SCIENTIFIC 5)		
S93	STACK: A-2 GA 1 (SCIENTIFIC FC 5)		
S94	STACK: A-2 GA 2/PASTING/GRIDCAST (SCIEN 6)		
S95	STACK: A-2 GA 3 (SCIENTIFIC 7)		
S96	STACK: OXIDE MILL 11		
S97	STACK: OXIDE MILL 12		
S98	STACK: OXIDE MILL 13		
S99	STACK: OXIDE MILL 14		
Z213	FUGITIVE : KEROSENE CLEANING		
Z400	FUGITIVE: A-4 MISCELLANEOUS COMBUSTION		
Z602	FUGITIVE: COLD CLEANERS & PART WASHERS		
Z605	FUGITIVE: BATTERY FINISHING		
Z608	FUGITIVE EMISSIONS		
Z64	FUGITIVE: A-1 PROCESS & HEAT		
Z65	FUGITIVE: IND- PROCESS & HEAT		
Z66	FUGITIVE: A-2 PROCESS & HEAT		
Z67	FUGITIVE: A-3 PROCESS & HEAT		
Z719	FUGITIVE: IND BATT FINISHING FOR A-3		
Z726	FUGITIVES: IND AUTO BATTERY FINISHING		
Z80	FUGITIVE: S-1 PROCESS & HEAT		

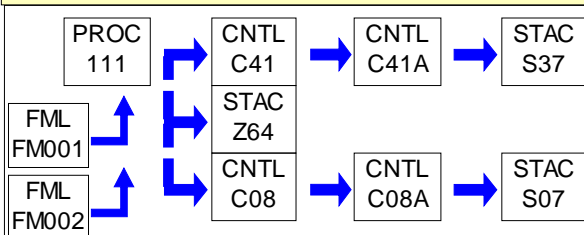
PERMIT MAPS



PERMIT MAPS

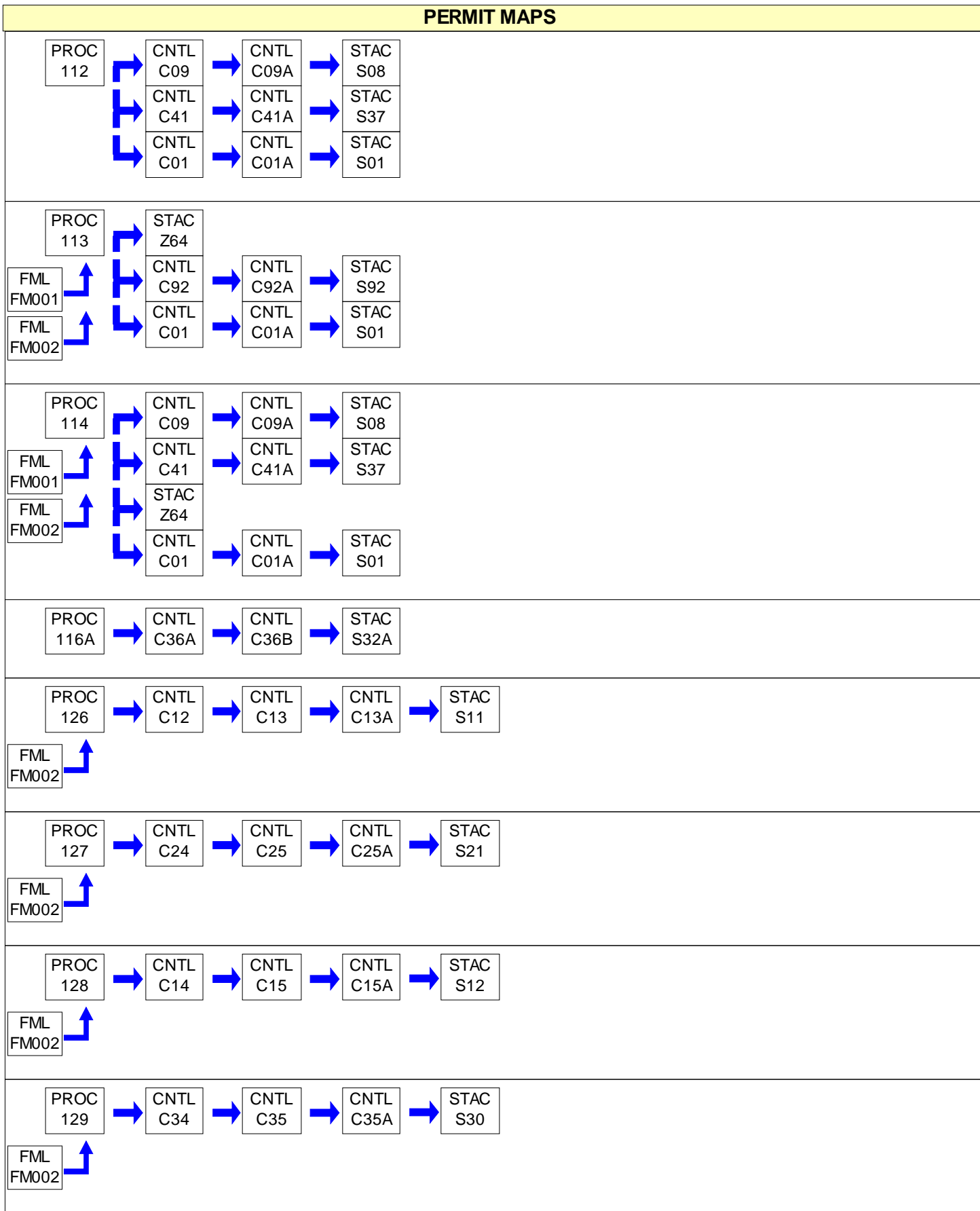



PERMIT MAPS

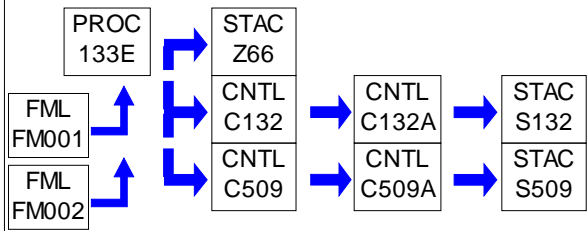
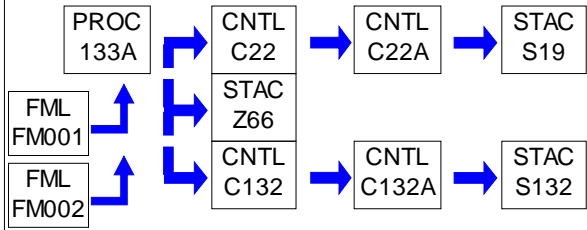
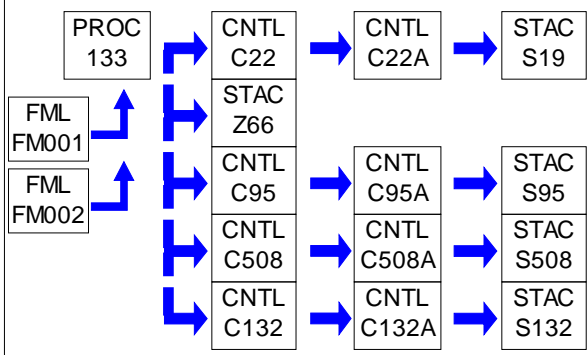
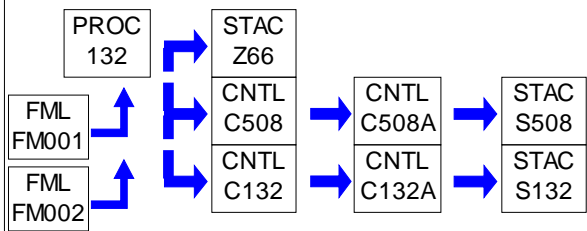
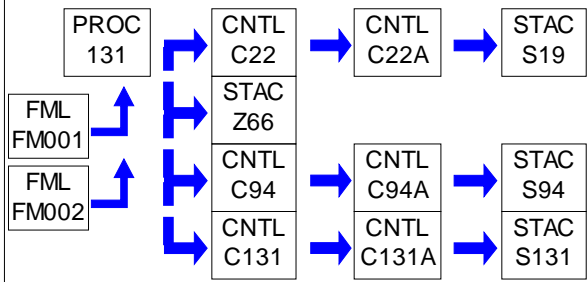
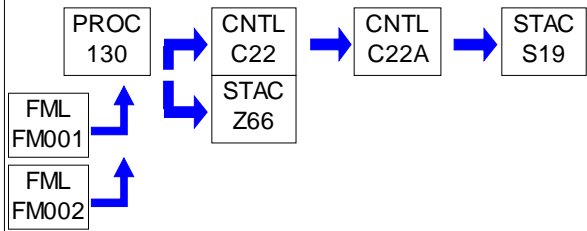



PERMIT MAPS

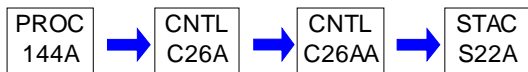
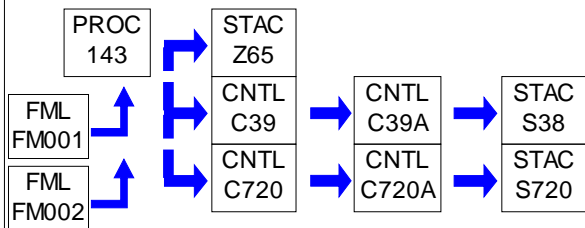
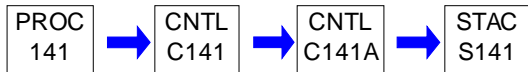
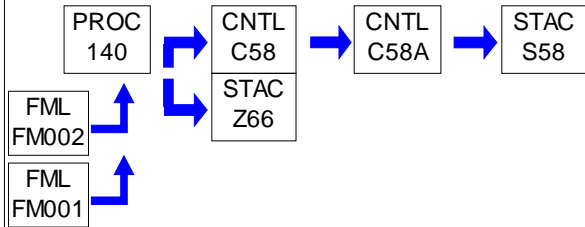
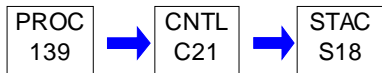
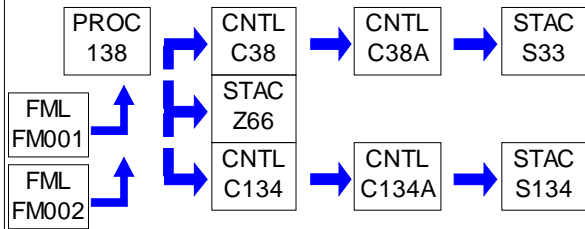
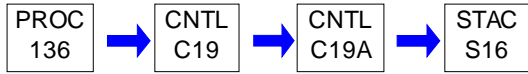
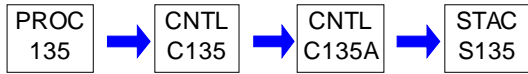
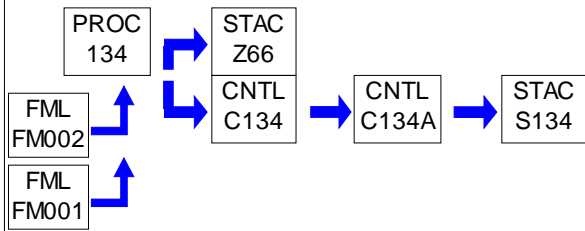



PERMIT MAPS

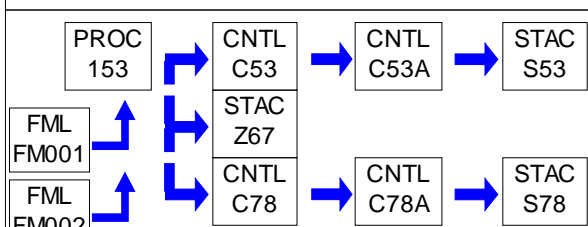
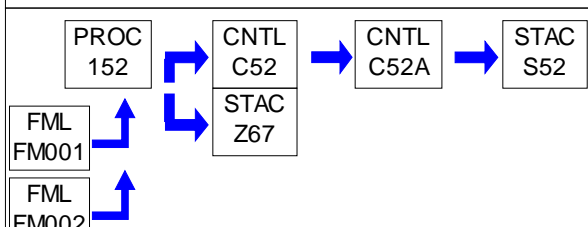
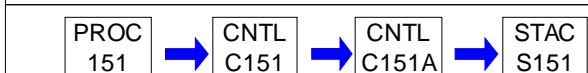
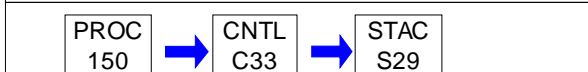
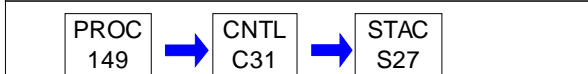
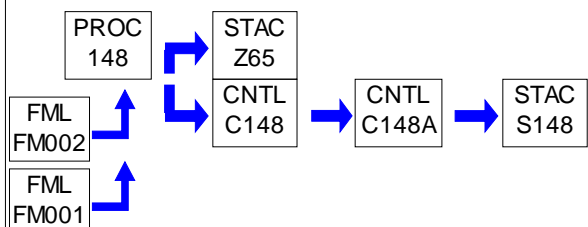
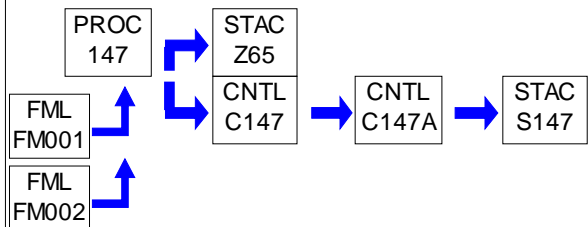
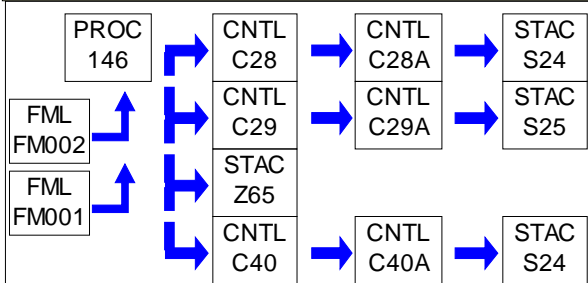



PERMIT MAPS

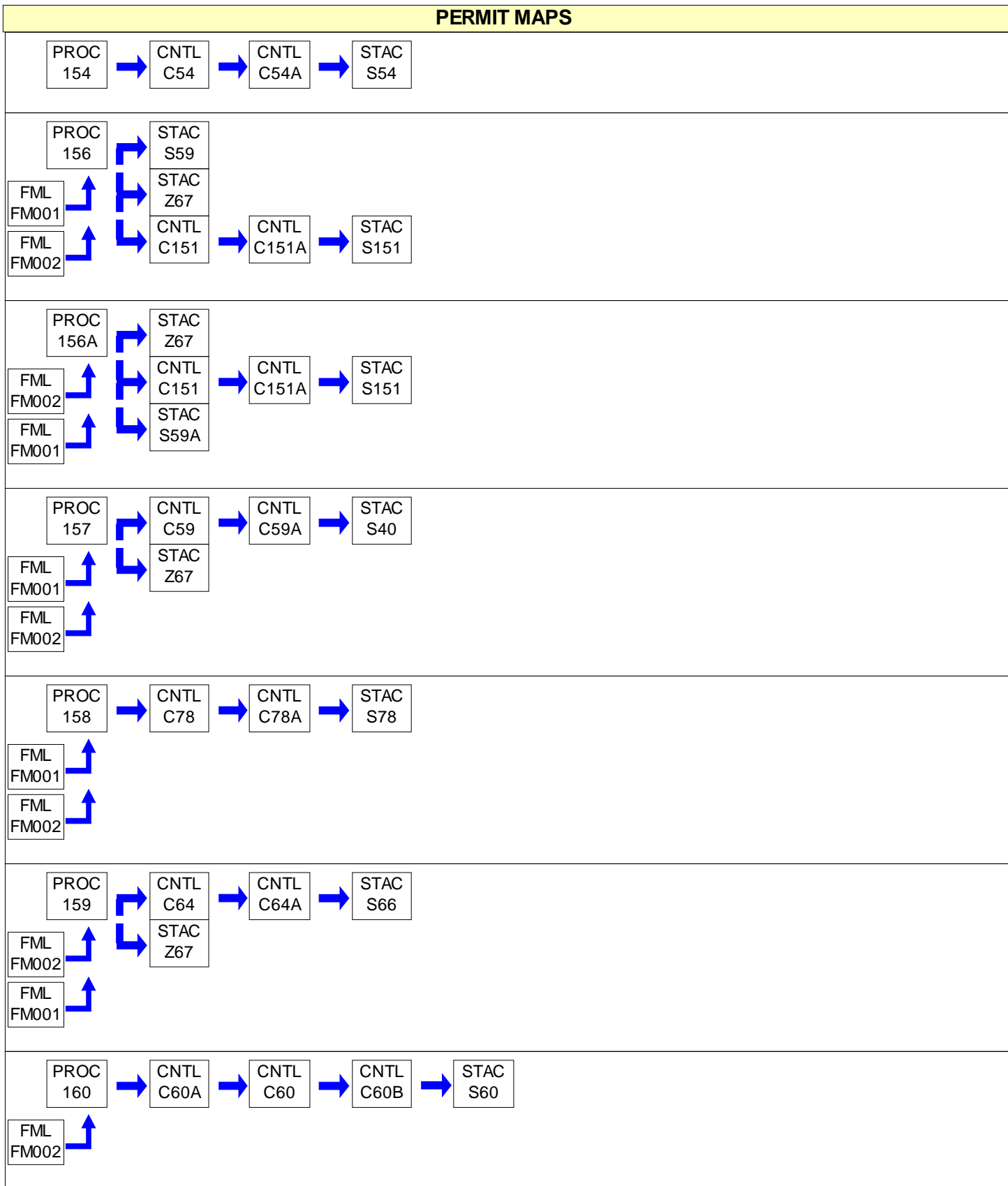



PERMIT MAPS

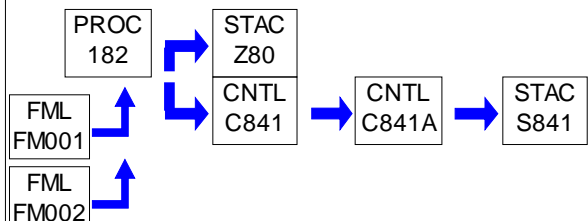
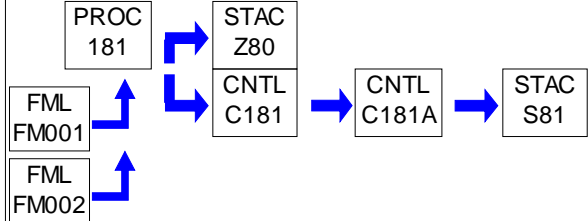
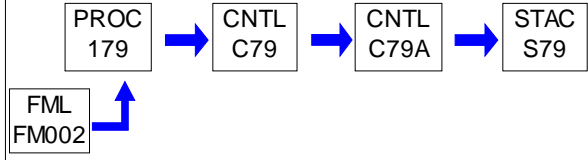
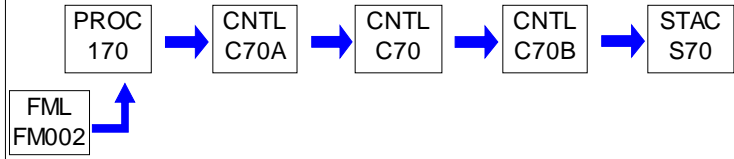
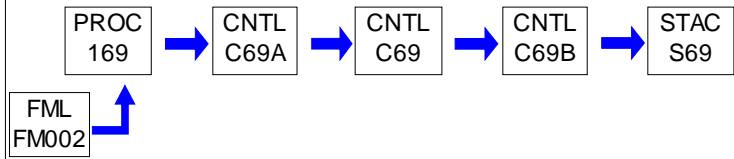
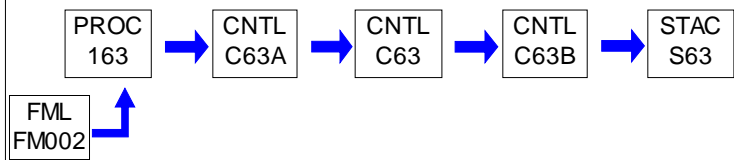
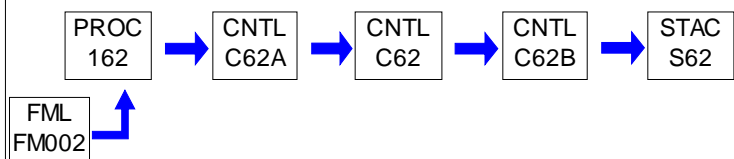
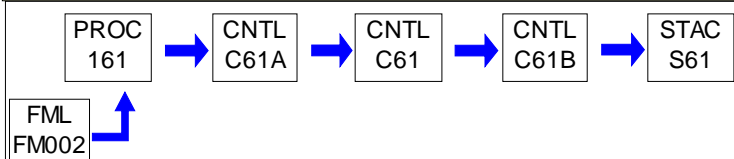



PERMIT MAPS

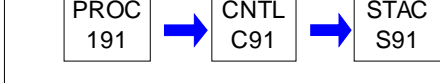
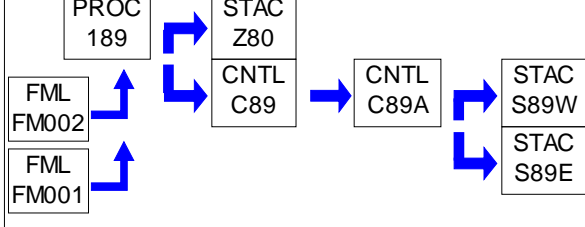
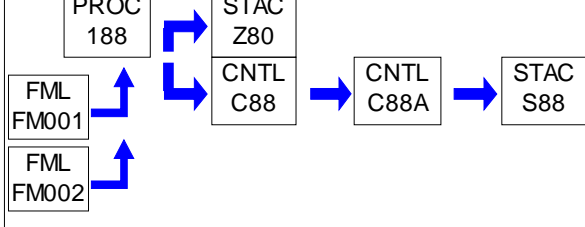
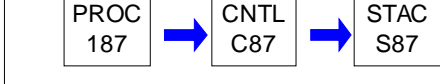
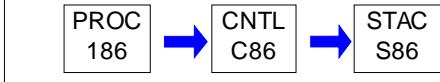
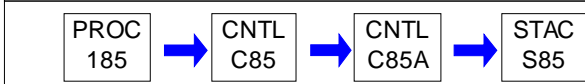
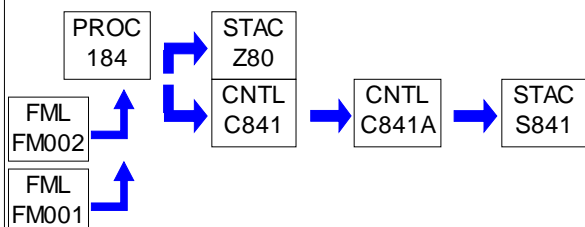
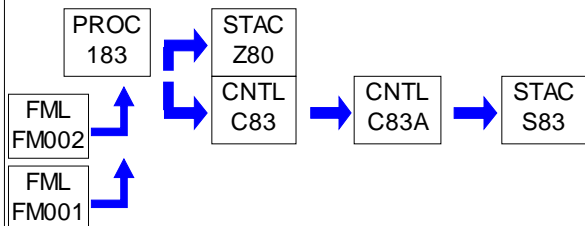
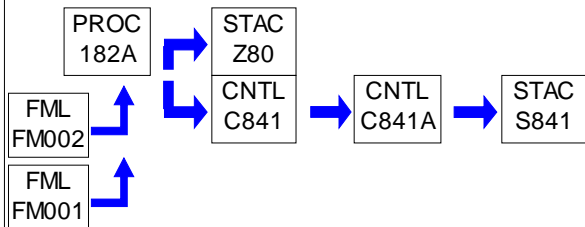



PERMIT MAPS

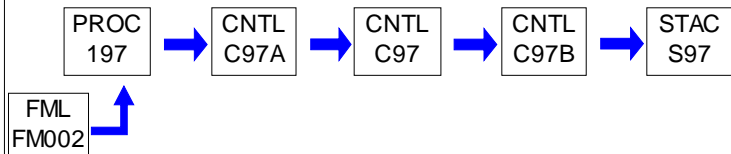
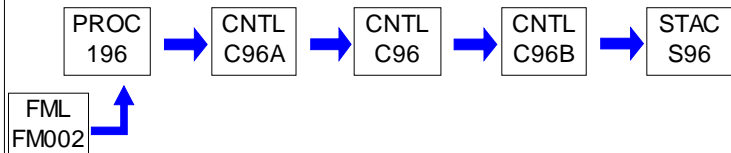
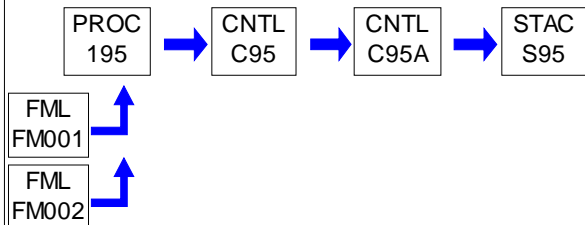
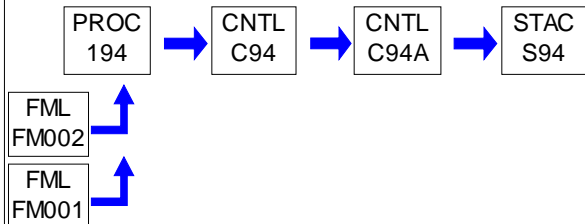
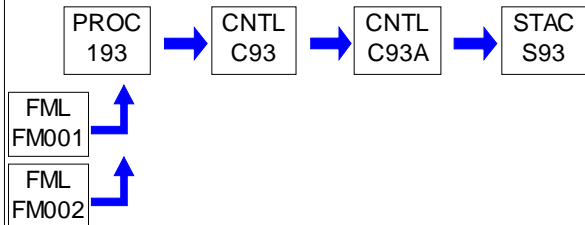
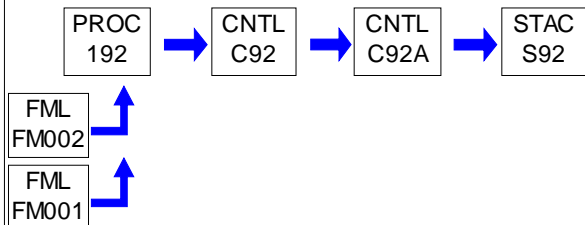
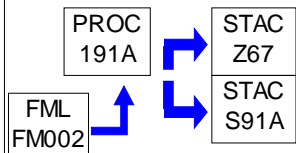



PERMIT MAPS

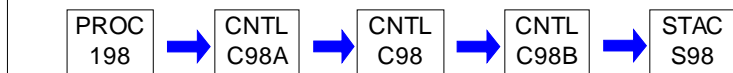

FML FM002

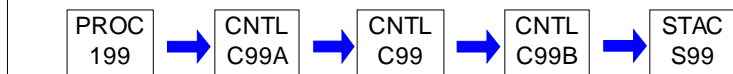

FML FM002

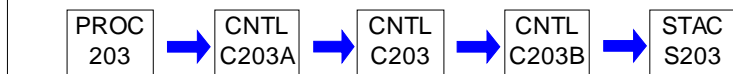

FML FM002

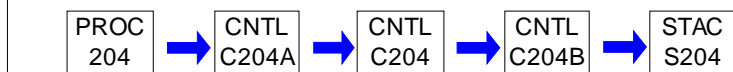

FML FM002

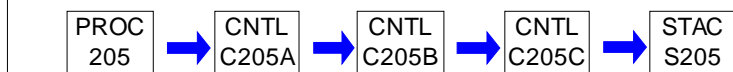

FML FM002

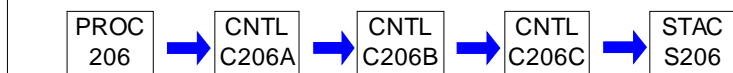

FML FM002

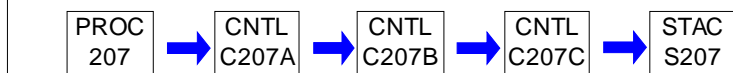

FML FM002

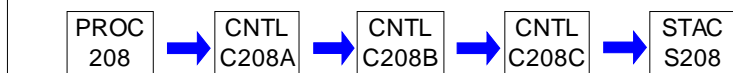

FML FM002

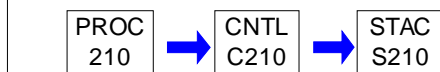

FML FM002



PERMIT MAPS

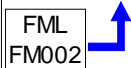
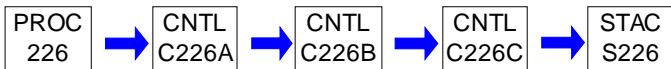
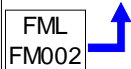
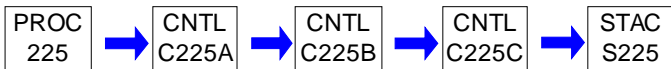
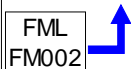
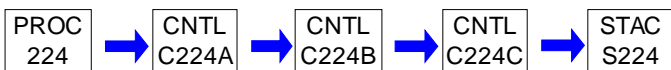
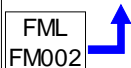
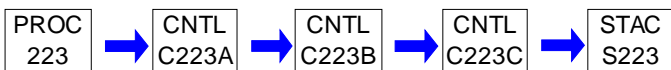
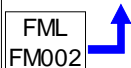
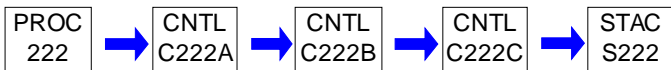
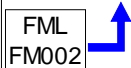
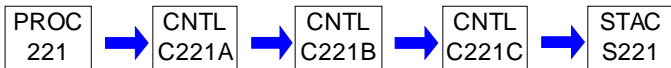
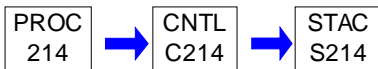
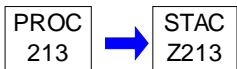
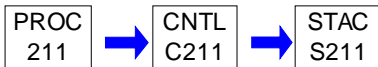



PERMIT MAPS

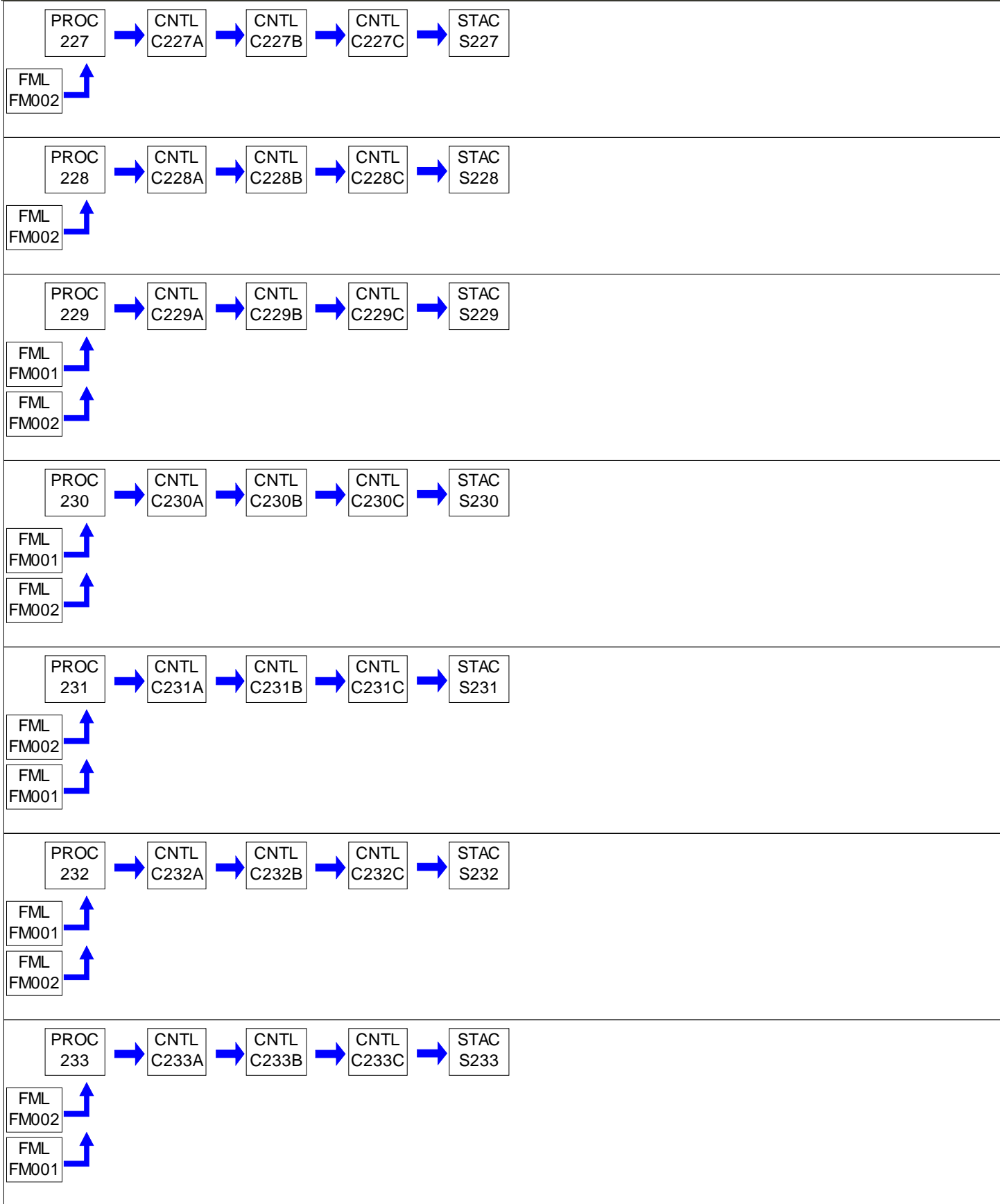



PERMIT MAPS

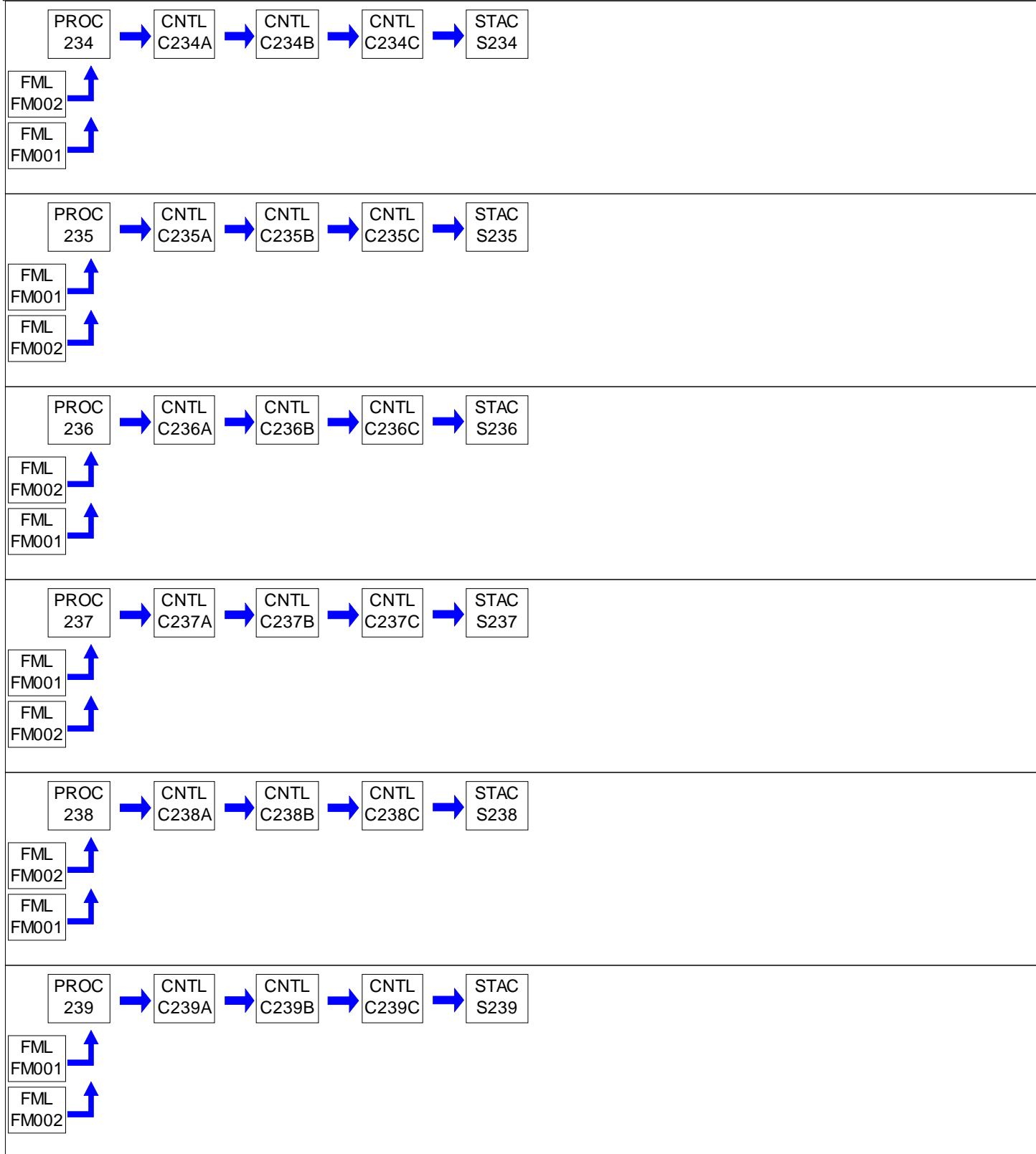



PERMIT MAPS

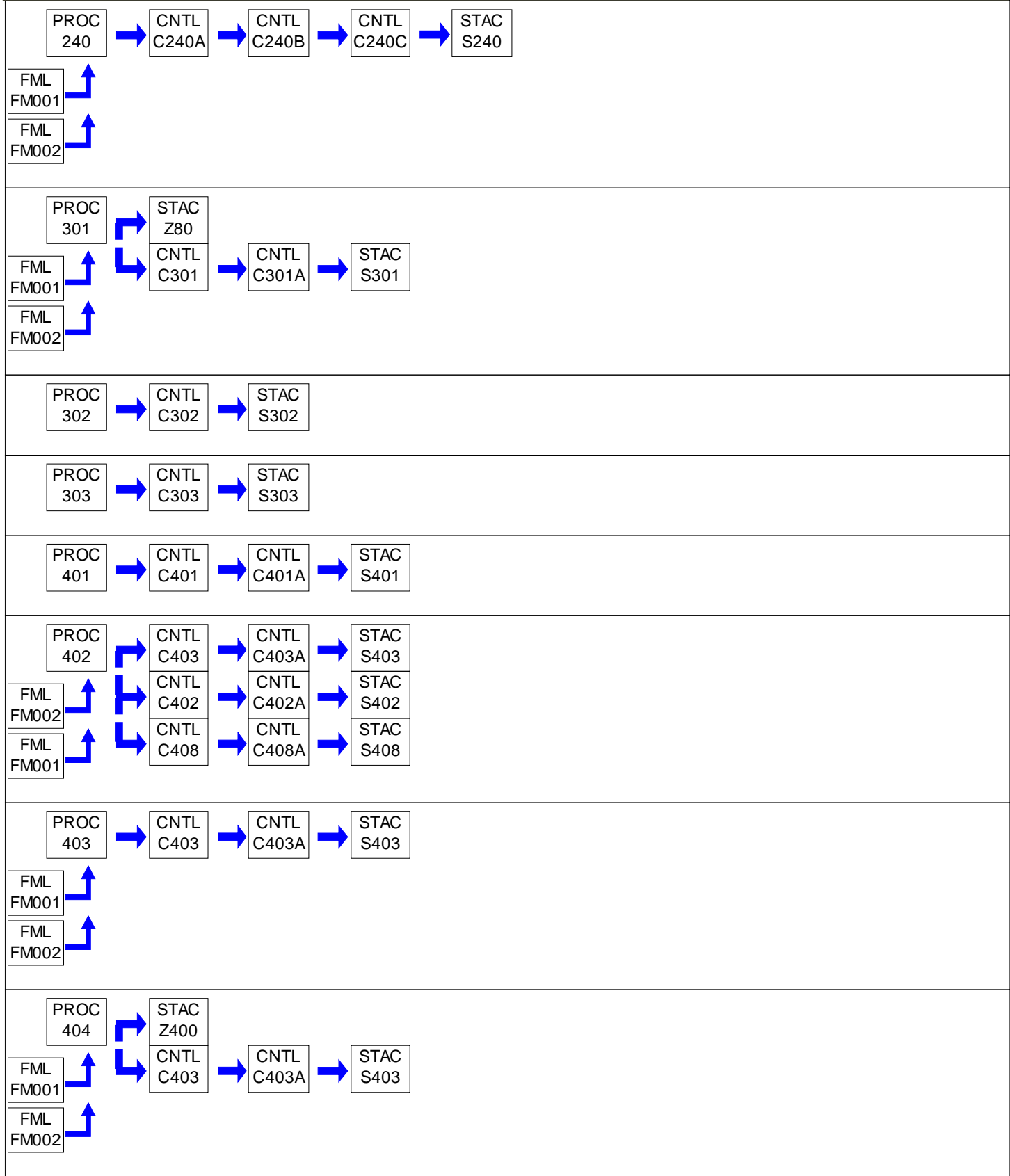



PERMIT MAPS

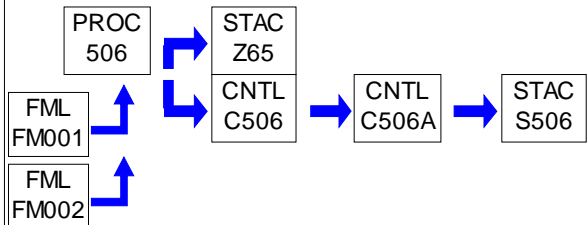
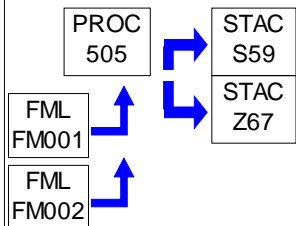
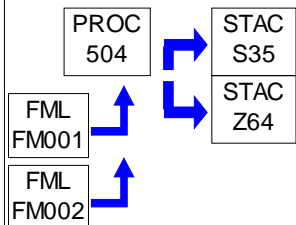
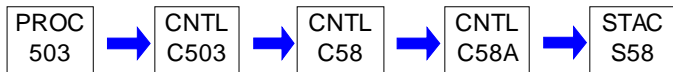
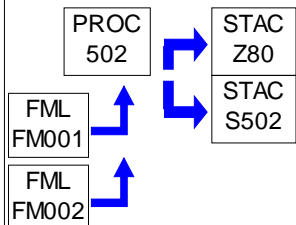
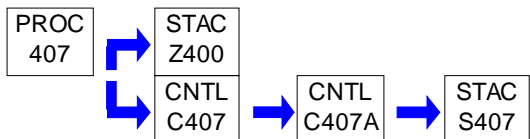
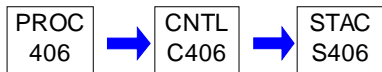
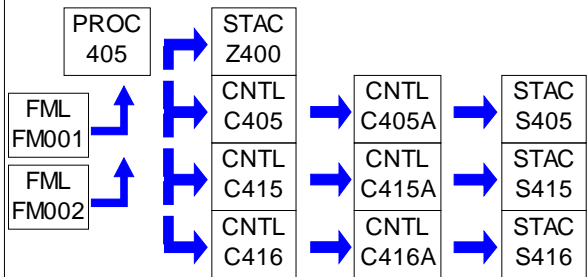



PERMIT MAPS

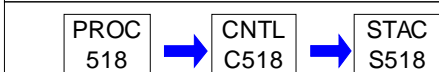
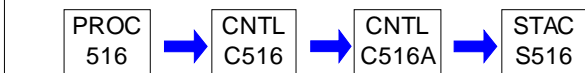
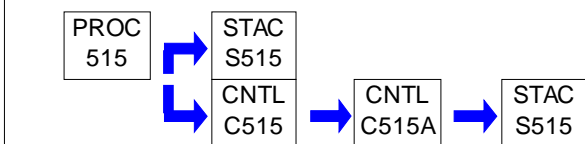
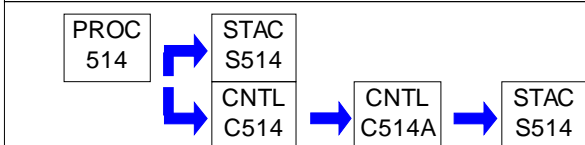
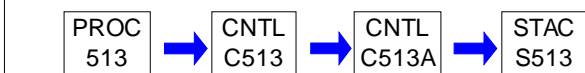
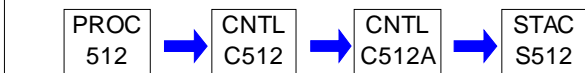
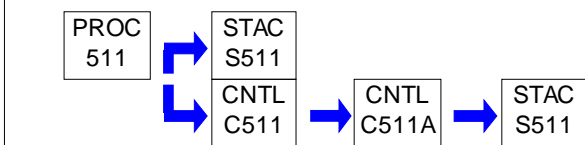
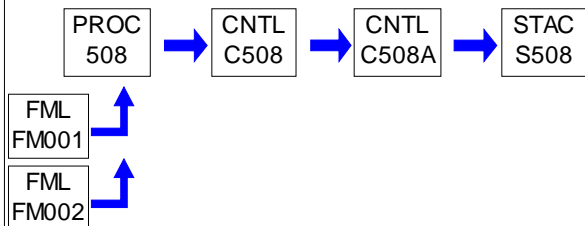
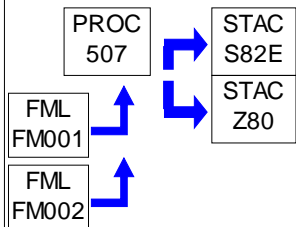



PERMIT MAPS

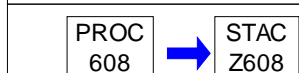
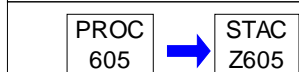
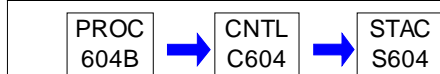
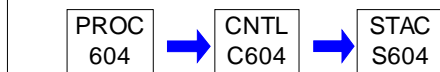
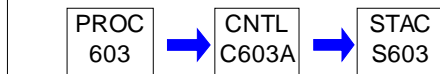
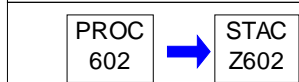
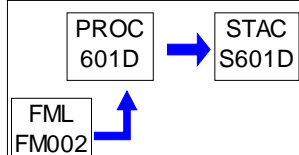
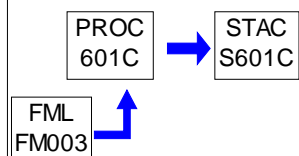
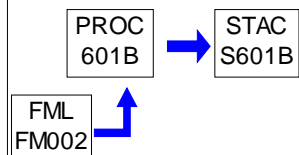
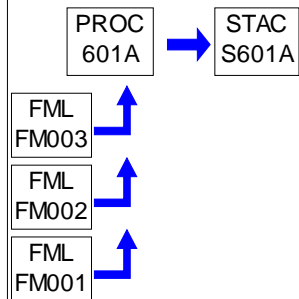



PERMIT MAPS

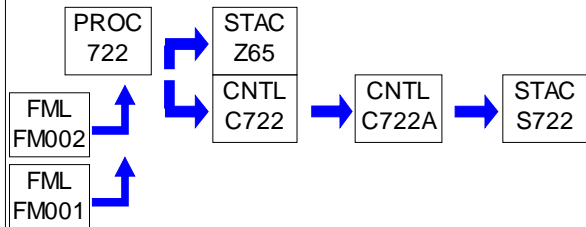
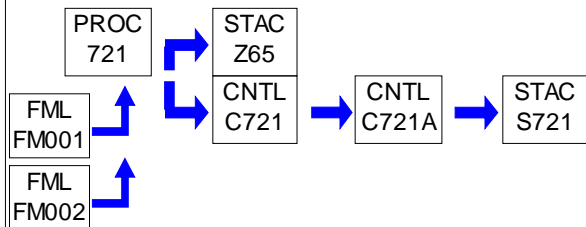
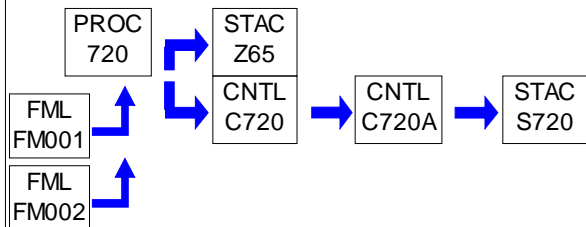
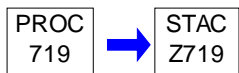
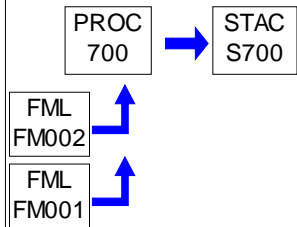
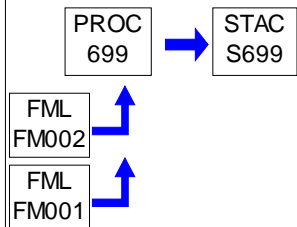



PERMIT MAPS

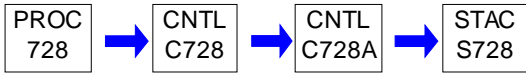
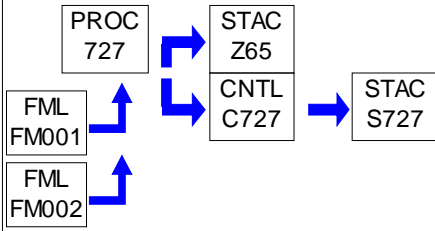
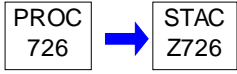
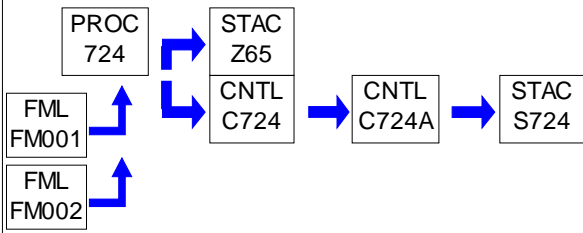

**SECTION B. General Title V Requirements****#001 [25 Pa. Code § 121.1]****Definitions**

Words and terms that are not otherwise defined in this permit shall have the meanings set forth in Section 3 of the Air Pollution Control Act (35 P.S. § 4003) and 25 Pa. Code § 121.1.

#002 [25 Pa. Code § 121.7]**Prohibition of Air Pollution**

No person may permit air pollution as that term is defined in the Air Pollution Control Act (35 P.S. §§ 4001-4015).

#003 [25 Pa. Code § 127.512(c)(4)]**Property Rights**

This permit does not convey property rights of any sort, or any exclusive privileges.

#004 [25 Pa. Code § 127.446(a) and (c)]**Permit Expiration**

This operating permit is issued for a fixed term of five (5) years and shall expire on the date specified on Page 1 of this permit. The terms and conditions of the expired permit shall automatically continue pending issuance of a new Title V permit, provided the permittee has submitted a timely and complete application and paid applicable fees required under 25 Pa. Code Chapter 127, Subchapter I and the Department is unable, through no fault of the permittee, to issue or deny a new permit before the expiration of the previous permit. An application is complete if it contains sufficient information to begin processing the application, has the applicable sections completed and has been signed by a responsible official.

#005 [25 Pa. Code §§ 127.412, 127.413, 127.414, 127.446(e), 127.503 & 127.704(b)]**Permit Renewal**

(a) An application for the renewal of the Title V permit shall be submitted to the Department at least six (6) months, and not more than 18 months, before the expiration date of this permit. The renewal application is timely if a complete application is submitted to the Department's Regional Air Manager within the timeframe specified in this permit condition.

(b) The application for permit renewal shall include the current permit number, the appropriate permit renewal fee, a description of any permit revisions and off-permit changes that occurred during the permit term, and any applicable requirements that were promulgated and not incorporated into the permit during the permit term. The fees shall be made payable to "The Commonwealth of Pennsylvania Clean Air Fund" and submitted with the fee form to the respective regional office.

(c) The renewal application shall also include submission of proof that the local municipality and county, in which the facility is located, have been notified in accordance with 25 Pa. Code § 127.413. The application for renewal of the Title V permit shall also include submission of compliance review forms which have been used by the permittee to update information submitted in accordance with either 25 Pa. Code § 127.412(b) or § 127.412(j).

(d) The permittee, upon becoming aware that any relevant facts were omitted or incorrect information was submitted in the permit application, shall promptly submit such supplementary facts or corrected information during the permit renewal process. The permittee shall also promptly provide additional information as necessary to address any requirements that become applicable to the source after the date a complete renewal application was submitted but prior to release of a draft permit.

#006 [25 Pa. Code §§ 127.450(a)(4) & 127.464(a)]**Transfer of Ownership or Operational Control**

(a) In accordance with 25 Pa. Code § 127.450(a)(4), a change in ownership or operational control of the source shall be treated as an administrative amendment if:

(1) The Department determines that no other change in the permit is necessary;

(2) A written agreement has been submitted to the Department identifying the specific date of the transfer of permit

**SECTION B. General Title V Requirements**

responsibility, coverage and liability between the current and the new permittee; and,

(3) A compliance review form has been submitted to the Department and the permit transfer has been approved by the Department.

(b) In accordance with 25 Pa. Code § 127.464(a), this permit may not be transferred to another person except in cases of transfer-of-ownership which are documented and approved to the satisfaction of the Department.

#007 [25 Pa. Code § 127.513, 35 P.S. § 4008 and § 114 of the CAA]**Inspection and Entry**

(a) Upon presentation of credentials and other documents as may be required by law for inspection and entry purposes, the permittee shall allow the Department of Environmental Protection or authorized representatives of the Department to perform the following:

(1) Enter at reasonable times upon the permittee's premises where a Title V source is located or emissions related activity is conducted, or where records are kept under the conditions of this permit;

(2) Have access to and copy or remove, at reasonable times, records that are kept under the conditions of this permit;

(3) Inspect at reasonable times, facilities, equipment including monitoring and air pollution control equipment, practices, or operations regulated or required under this permit;

(4) Sample or monitor, at reasonable times, substances or parameters, for the purpose of assuring compliance with the permit or applicable requirements as authorized by the Clean Air Act, the Air Pollution Control Act, or the regulations promulgated under the Acts.

(b) Pursuant to 35 P.S. § 4008, no person shall hinder, obstruct, prevent or interfere with the Department or its personnel in the performance of any duty authorized under the Air Pollution Control Act.

(c) Nothing in this permit condition shall limit the ability of the EPA to inspect or enter the premises of the permittee in accordance with Section 114 or other applicable provisions of the Clean Air Act.

#008 [25 Pa. Code §§ 127.25, 127.444, & 127.512(c)(1)]**Compliance Requirements**

(a) The permittee shall comply with the conditions of this permit. Noncompliance with this permit constitutes a violation of the Clean Air Act and the Air Pollution Control Act and is grounds for one (1) or more of the following:

(1) Enforcement action

(2) Permit termination, revocation and reissuance or modification

(3) Denial of a permit renewal application

(b) A person may not cause or permit the operation of a source, which is subject to 25 Pa. Code Article III, unless the source(s) and air cleaning devices identified in the application for the plan approval and operating permit and the plan approval issued to the source are operated and maintained in accordance with specifications in the applications and the conditions in the plan approval and operating permit issued by the Department. A person may not cause or permit the operation of an air contamination source subject to 25 Pa. Code Chapter 127 in a manner inconsistent with good operating practices.

(c) For purposes of Sub-condition (b) of this permit condition, the specifications in applications for plan approvals and operating permits are the physical configurations and engineering design details which the Department determines are essential for the permittee's compliance with the applicable requirements in this Title V permit.

**SECTION B. General Title V Requirements****#009 [25 Pa. Code § 127.512(c)(2)]****Need to Halt or Reduce Activity Not a Defense**

It shall not be a defense for a permittee in an enforcement action that it would have been necessary to halt or reduce the permitted activity in order to maintain compliance with the conditions of this permit.

#010 [25 Pa. Code §§ 127.411(d) & 127.512(c)(5)]**Duty to Provide Information**

(a) The permittee shall furnish to the Department, within a reasonable time, information that the Department may request in writing to determine whether cause exists for modifying, revoking and reissuing, or terminating the permit, or to determine compliance with the permit.

(b) Upon request, the permittee shall also furnish to the Department copies of records that the permittee is required to keep by this permit, or for information claimed to be confidential, the permittee may furnish such records directly to the Administrator of EPA along with a claim of confidentiality.

#011 [25 Pa. Code §§ 127.463, 127.512(c)(3) & 127.542]**Reopening and Revising the Title V Permit for Cause**

(a) This Title V permit may be modified, revoked, reopened and reissued or terminated for cause. The filing of a request by the permittee for a permit modification, revocation and reissuance, or termination, or of a notification of planned changes or anticipated noncompliance does not stay a permit condition.

(b) This permit may be reopened, revised and reissued prior to expiration of the permit under one or more of the following circumstances:

(1) Additional applicable requirements under the Clean Air Act or the Air Pollution Control Act become applicable to a Title V facility with a remaining permit term of three (3) or more years prior to the expiration date of this permit. The Department will revise the permit as expeditiously as practicable but not later than 18 months after promulgation of the applicable standards or regulations. No such revision is required if the effective date of the requirement is later than the expiration date of this permit, unless the original permit or its terms and conditions has been extended.

(2) Additional requirements, including excess emissions requirements, become applicable to an affected source under the acid rain program. Upon approval by the Administrator of EPA, excess emissions offset plans for an affected source shall be incorporated into the permit.

(3) The Department or the EPA determines that this permit contains a material mistake or inaccurate statements were made in establishing the emissions standards or other terms or conditions of this permit.

(4) The Department or the Administrator of EPA determines that the permit must be revised or revoked to assure compliance with the applicable requirements.

(c) Proceedings to revise this permit shall follow the same procedures which apply to initial permit issuance and shall affect only those parts of this permit for which cause to revise exists. The revision shall be made as expeditiously as practicable.

(d) Regardless of whether a revision is made in accordance with (b)(1) above, the permittee shall meet the applicable standards or regulations promulgated under the Clean Air Act within the time frame required by standards or regulations.

#012 [25 Pa. Code § 127.543]**Reopening a Title V Permit for Cause by EPA**

As required by the Clean Air Act and regulations adopted thereunder, this permit may be modified, reopened and reissued, revoked or terminated for cause by EPA in accordance with procedures specified in 25 Pa. Code § 127.543.

**SECTION B. General Title V Requirements****#013 [25 Pa. Code § 127.522(a)]****Operating Permit Application Review by the EPA**

The applicant may be required by the Department to provide a copy of the permit application, including the compliance plan, directly to the Administrator of the EPA. Copies of title V permit applications to EPA, pursuant to 25 PA Code §127.522(a), shall be submitted, if required, to the following EPA e-mail box:

R3_Air_Apps_and_Notices@epa.gov

Please place the following in the subject line: TV [permit number], [Facility Name].

#014 [25 Pa. Code § 127.541]**Significant Operating Permit Modifications**

When permit modifications during the term of this permit do not qualify as minor permit modifications or administrative amendments, the permittee shall submit an application for significant Title V permit modifications in accordance with 25 Pa. Code § 127.541. Notifications to EPA, pursuant to 25 PA Code §127.522(a), if required, shall be submitted, to the following EPA e-mail box:

R3_Air_Apps_and_Notices@epa.gov

Please place the following in the subject line: TV [permit number], [Facility Name].

#015 [25 Pa. Code §§ 121.1 & 127.462]**Minor Operating Permit Modifications**

The permittee may make minor operating permit modifications (as defined in 25 Pa. Code §121.1), on an expedited basis, in accordance with 25 Pa. Code §127.462 (relating to minor operating permit modifications). Notifications to EPA, pursuant to 25 PA Code §127.462(c), if required, shall be submitted, to the following EPA e-mail box:

R3_Air_Apps_and_Notices@epa.gov

Please place the following in the subject line: TV [permit number], [Facility Name].

#016 [25 Pa. Code § 127.450]**Administrative Operating Permit Amendments**

(a) The permittee may request administrative operating permit amendments, as defined in 25 Pa. Code §127.450(a). Copies of request for administrative permit amendment to EPA, pursuant to 25 PA Code §127.450(c)(1), if required, shall be submitted to the following EPA e-mail box:

R3_Air_Apps_and_Notices@epa.gov

Please place the following in the subject line: TV [permit number], [Facility Name].

(b) Upon final action by the Department granting a request for an administrative operating permit amendment covered under §127.450(a)(5), the permit shield provisions in 25 Pa. Code § 127.516 (relating to permit shield) shall apply to administrative permit amendments incorporated in this Title V Permit in accordance with §127.450(c), unless precluded by the Clean Air Act or the regulations thereunder.

#017 [25 Pa. Code § 127.512(b)]**Severability Clause**

The provisions of this permit are severable, and if any provision of this permit is determined by the Environmental Hearing Board or a court of competent jurisdiction, or US EPA to be invalid or unenforceable, such a determination will not affect the remaining provisions of this permit.

**SECTION B. General Title V Requirements****#018 [25 Pa. Code §§ 127.704, 127.705 & 127.707]****Fee Payment**

- (a) The permittee shall pay fees to the Department in accordance with the applicable fee schedules in 25 Pa. Code Chapter 127, Subchapter I (relating to plan approval and operating permit fees). The applicable fees shall be made payable to "The Commonwealth of Pennsylvania Clean Air Fund" with the permit number clearly indicated and submitted to the respective regional office.
- (b) Emission Fees. The permittee shall, on or before September 1st of each year, pay applicable annual Title V emission fees for emissions occurring in the previous calendar year as specified in 25 Pa. Code § 127.705. The permittee is not required to pay an emission fee for emissions of more than 4,000 tons of each regulated pollutant emitted from the facility.
- (c) As used in this permit condition, the term "regulated pollutant" is defined as a VOC, each pollutant regulated under Sections 111 and 112 of the Clean Air Act and each pollutant for which a National Ambient Air Quality Standard has been promulgated, except that carbon monoxide is excluded.
- (d) Late Payment. Late payment of emission fees will subject the permittee to the penalties prescribed in 25 Pa. Code § 127.707 and may result in the suspension or termination of the Title V permit. The permittee shall pay a penalty of fifty percent (50%) of the fee amount, plus interest on the fee amount computed in accordance with 26 U.S.C.A. § 6621(a)(2) from the date the emission fee should have been paid in accordance with the time frame specified in 25 Pa. Code § 127.705(c).
- (e) The permittee shall pay an annual operating permit maintenance fee according to the following fee schedule established in 25 Pa. Code § 127.704(d) on or before December 31 of each year for the next calendar year.
- (1) Eight thousand dollars (\$8,000) for calendar years 2021—2025.
 - (2) Ten thousand dollars (\$10,000) for calendar years 2026—2030.
 - (3) Twelve thousand five hundred dollars (\$12,500) for the calendar years beginning with 2031.

#019 [25 Pa. Code §§ 127.14(b) & 127.449]**Authorization for De Minimis Emission Increases**

(a) This permit authorizes de minimis emission increases from a new or existing source in accordance with 25 Pa. Code §§ 127.14 and 127.449 without the need for a plan approval or prior issuance of a permit modification. The permittee shall provide the Department with seven (7) days prior written notice before commencing any de minimis emissions increase that would result from either: (1) a physical change of minor significance under § 127.14(c)(1); or (2) the construction, installation, modification or reactivation of an air contamination source. The written notice shall:

- (1) Identify and describe the pollutants that will be emitted as a result of the de minimis emissions increase.
- (2) Provide emission rates expressed in tons per year and in terms necessary to establish compliance consistent with any applicable requirement.

The Department may disapprove or condition de minimis emission increases at any time.

(b) Except as provided below in (c) and (d) of this permit condition, the permittee is authorized during the term of this permit to make de minimis emission increases (expressed in tons per year) up to the following amounts without the need for a plan approval or prior issuance of a permit modification:

- (1) Four tons of carbon monoxide from a single source during the term of the permit and 20 tons of carbon monoxide at the facility during the term of the permit.
- (2) One ton of NO_x from a single source during the term of the permit and 5 tons of NO_x at the facility during the term of the permit.
- (3) One and six-tenths tons of the oxides of sulfur from a single source during the term of the permit and 8.0 tons of

**SECTION B. General Title V Requirements**

oxides of sulfur at the facility during the term of the permit.

(4) Six-tenths of a ton of PM₁₀ from a single source during the term of the permit and 3.0 tons of PM₁₀ at the facility during the term of the permit. This shall include emissions of a pollutant regulated under Section 112 of the Clean Air Act unless precluded by the Clean Air Act or 25 Pa. Code Article III.

(5) One ton of VOCs from a single source during the term of the permit and 5.0 tons of VOCs at the facility during the term of the permit. This shall include emissions of a pollutant regulated under Section 112 of the Clean Air Act unless precluded by the Clean Air Act or 25 Pa. Code Article III.

(c) In accordance with § 127.14, the permittee may install the following minor sources without the need for a plan approval:

(1) Air conditioning or ventilation systems not designed to remove pollutants generated or released from other sources.

(2) Combustion units rated at 2,500,000 or less Btu per hour of heat input.

(3) Combustion units with a rated capacity of less than 10,000,000 Btu per hour heat input fueled by natural gas supplied by a public utility, liquefied petroleum gas or by commercial fuel oils which are No. 2 or lighter, viscosity less than or equal to 5.82 c St, and which meet the sulfur content requirements of 25 Pa. Code § 123.22 (relating to combustion units). For purposes of this permit, commercial fuel oil shall be virgin oil which has no reprocessed, recycled or waste material added.

(4) Space heaters which heat by direct heat transfer.

(5) Laboratory equipment used exclusively for chemical or physical analysis.

(6) Other sources and classes of sources determined to be of minor significance by the Department.

(d) This permit does not authorize de minimis emission increases if the emissions increase would cause one or more of the following:

(1) Increase the emissions of a pollutant regulated under Section 112 of the Clean Air Act except as authorized in Subparagraphs (b)(4) and (5) of this permit condition.

(2) Subject the facility to the prevention of significant deterioration requirements in 25 Pa. Code Chapter 127, Subchapter D and/or the new source review requirements in Subchapter E.

(3) Violate any applicable requirement of the Air Pollution Control Act, the Clean Air Act, or the regulations promulgated under either of the acts.

(4) Changes which are modifications under any provision of Title I of the Clean Air Act and emission increases which would exceed the allowable emissions level (expressed as a rate of emissions or in terms of total emissions) under the Title V permit.

(e) Unless precluded by the Clean Air Act or the regulations thereunder, the permit shield described in 25 Pa. Code § 127.516 (relating to permit shield) shall extend to the changes made under 25 Pa. Code § 127.449 (relating to de minimis emission increases).

(f) Emissions authorized under this permit condition shall be included in the monitoring, recordkeeping and reporting requirements of this permit.

(g) Except for de minimis emission increases allowed under this permit, 25 Pa. Code § 127.449, or sources and physical changes meeting the requirements of 25 Pa. Code § 127.14, the permittee is prohibited from making physical changes or engaging in activities that are not specifically authorized under this permit without first applying for a plan approval. In accordance with § 127.14(b), a plan approval is not required for the construction, modification, reactivation, or installation of the sources creating the de minimis emissions increase.

**SECTION B. General Title V Requirements**

(h) The permittee may not meet de minimis emission threshold levels by offsetting emission increases or decreases at the same source.

#020 [25 Pa. Code §§ 127.11a & 127.215]**Reactivation of Sources**

(a) The permittee may reactivate a source at the facility that has been out of operation or production for at least one year, but less than or equal to five (5) years, if the source is reactivated in accordance with the requirements of 25 Pa. Code §§ 127.11a and 127.215. The reactivated source will not be considered a new source.

(b) A source which has been out of operation or production for more than five (5) years but less than 10 years may be reactivated and will not be considered a new source if the permittee satisfies the conditions specified in 25 Pa. Code § 127.11a(b).

#021 [25 Pa. Code §§ 121.9 & 127.216]**Circumvention**

(a) The owner of this Title V facility, or any other person, may not circumvent the new source review requirements of 25 Pa. Code Chapter 127, Subchapter E by causing or allowing a pattern of ownership or development, including the phasing, staging, delaying or engaging in incremental construction, over a geographic area of a facility which, except for the pattern of ownership or development, would otherwise require a permit or submission of a plan approval application.

(b) No person may permit the use of a device, stack height which exceeds good engineering practice stack height, dispersion technique or other technique which, without resulting in reduction of the total amount of air contaminants emitted, conceals or dilutes an emission of air contaminants which would otherwise be in violation of this permit, the Air Pollution Control Act or the regulations promulgated thereunder, except that with prior approval of the Department, the device or technique may be used for control of malodors.

#022 [25 Pa. Code §§ 127.402(d) & 127.513(1)]**Submissions**

(a) Reports, test data, monitoring data, notifications and requests for renewal of the permit shall be submitted to the:

Regional Air Program Manager
PA Department of Environmental Protection
(At the address given on the permit transmittal letter, or otherwise notified)

(b) Any report or notification for the EPA Administrator or EPA Region III should be addressed to:

Enforcement & Compliance Assurance Division
Air, RCRA and Toxics Branch (3ED21)
Four Penn Center
1600 John F. Kennedy Boulevard
Philadelphia, PA 19103-2852

The Title V compliance certification shall be emailed to EPA at R3_APD_Permits@epa.gov.

(c) An application, form, report or compliance certification submitted pursuant to this permit condition shall contain certification by a responsible official as to truth, accuracy, and completeness as required under 25 Pa. Code § 127.402(d). Unless otherwise required by the Clean Air Act or regulations adopted thereunder, this certification and any other certification required pursuant to this permit shall state that, based on information and belief formed after reasonable inquiry, the statements and information in the document are true, accurate and complete.

#023 [25 Pa. Code §§ 127.441(c) & 127.463(e); Chapter 139; & 114(a)(3), 504(b) of the CAA]**Sampling, Testing and Monitoring Procedures**

(a) The permittee shall perform the emissions monitoring and analysis procedures or test methods for applicable requirements of this Title V permit. In addition to the sampling, testing and monitoring procedures specified in this

**SECTION B. General Title V Requirements**

permit, the Permittee shall comply with any additional applicable requirements promulgated under the Clean Air Act after permit issuance regardless of whether the permit is revised.

(b) The sampling, testing and monitoring required under the applicable requirements of this permit, shall be conducted in accordance with the requirements of 25 Pa. Code Chapter 139 unless alternative methodology is required by the Clean Air Act (including §§ 114(a)(3) and 504(b)) and regulations adopted thereunder.

#024 [25 Pa. Code § 127.513]**Compliance Certification**

(a) One year after the date of issuance of the Title V permit, and each year thereafter, unless specified elsewhere in the permit, the permittee shall submit to the Department and EPA Region III a certificate of compliance with the terms and conditions in this permit, for the previous year, including the emission limitations, standards or work practices.

This certification shall include:

- (1) The identification of each term or condition of the permit that is the basis of the certification.
- (2) The compliance status.
- (3) The methods used for determining the compliance status of the source, currently and over the reporting period.
- (4) Whether compliance was continuous or intermittent.

(b) The compliance certification shall be postmarked or hand-delivered no later than thirty days after each anniversary of the date of issuance of this Title V Operating Permit, or on the submittal date specified elsewhere in the permit, to the Department in accordance with the submission requirements specified in Section B, Condition #022 of this permit. The Title V compliance certification shall be emailed to EPA at R3_APD_Permits@epa.gov.

#025 [25 Pa. Code §§ 127.511 & Chapter 135]**Recordkeeping Requirements**

(a) The permittee shall maintain and make available, upon request by the Department, records of required monitoring information that include the following:

- (1) The date, place (as defined in the permit) and time of sampling or measurements.
- (2) The dates the analyses were performed.
- (3) The company or entity that performed the analyses.
- (4) The analytical techniques or methods used.
- (5) The results of the analyses.
- (6) The operating conditions as existing at the time of sampling or measurement.

(b) The permittee shall retain records of the required monitoring data and supporting information for at least five (5) years from the date of the monitoring sample, measurement, report or application. Supporting information includes the calibration data and maintenance records and original strip-chart recordings for continuous monitoring instrumentation, and copies of reports required by the permit.

(c) The permittee shall maintain and make available to the Department upon request, records including computerized records that may be necessary to comply with the reporting, recordkeeping and emission statement requirements in 25 Pa. Code Chapter 135 (relating to reporting of sources). In accordance with 25 Pa. Code Chapter 135, § 135.5, such records may include records of production, fuel usage, maintenance of production or pollution control equipment or other information determined by the Department to be necessary for identification and quantification of potential and actual air contaminant emissions. If direct recordkeeping is not possible or practical, sufficient records shall be kept to provide the needed information by indirect means.

**SECTION B. General Title V Requirements****#026 [25 Pa. Code §§ 127.411(d), 127.442, 127.463(e) & 127.511(c)]****Reporting Requirements**

(a) The permittee shall comply with the reporting requirements for the applicable requirements specified in this Title V permit. In addition to the reporting requirements specified herein, the permittee shall comply with any additional applicable reporting requirements promulgated under the Clean Air Act after permit issuance regardless of whether the permit is revised.

(b) Pursuant to 25 Pa. Code § 127.511(c), the permittee shall submit reports of required monitoring at least every six (6) months unless otherwise specified in this permit. Instances of deviations (as defined in 25 Pa. Code § 121.1) from permit requirements shall be clearly identified in the reports. The reporting of deviations shall include the probable cause of the deviations and corrective actions or preventative measures taken, except that sources with continuous emission monitoring systems shall report according to the protocol established and approved by the Department for the source. The required reports shall be certified by a responsible official.

(c) Every report submitted to the Department under this permit condition shall comply with the submission procedures specified in Section B, Condition #022(c) of this permit.

(d) Any records, reports or information obtained by the Department or referred to in a public hearing shall be made available to the public by the Department except for such records, reports or information for which the permittee has shown cause that the documents should be considered confidential and protected from disclosure to the public under Section 4013.2 of the Air Pollution Control Act and consistent with Sections 112(d) and 114(c) of the Clean Air Act and 25 Pa. Code § 127.411(d). The permittee may not request a claim of confidentiality for any emissions data generated for the Title V facility.

#027 [25 Pa. Code § 127.3]**Operational Flexibility**

The permittee is authorized to make changes within the Title V facility in accordance with the following provisions in 25 Pa. Code Chapter 127 which implement the operational flexibility requirements of Section 502(b)(10) of the Clean Air Act and Section 6.1(i) of the Air Pollution Control Act:

- (1) Section 127.14 (relating to exemptions)
- (2) Section 127.447 (relating to alternative operating scenarios)
- (3) Section 127.448 (relating to emissions trading at facilities with federally enforceable emissions caps)
- (4) Section 127.449 (relating to de minimis emission increases)
- (5) Section 127.450 (relating to administrative operating permit amendments)
- (6) Section 127.462 (relating to minor operating permit amendments)
- (7) Subchapter H (relating to general plan approvals and operating permits)

#028 [25 Pa. Code §§ 127.441(d), 127.512(i) and 40 CFR Part 68]**Risk Management**

(a) If required by Section 112(r) of the Clean Air Act, the permittee shall develop and implement an accidental release program consistent with requirements of the Clean Air Act, 40 CFR Part 68 (relating to chemical accident prevention provisions) and the Federal Chemical Safety Information, Site Security and Fuels Regulatory Relief Act (P.L. 106-40).

(b) The permittee shall prepare and implement a Risk Management Plan (RMP) which meets the requirements of Section 112(r) of the Clean Air Act, 40 CFR Part 68 and the Federal Chemical Safety Information, Site Security and Fuels Regulatory Relief Act when a regulated substance listed in 40 CFR § 68.130 is present in a process in more than the listed threshold quantity at the Title V facility. The permittee shall submit the RMP to the federal Environmental Protection Agency according to the following schedule and requirements:

- (1) The permittee shall submit the first RMP to a central point specified by EPA no later than the latest of the following:

**SECTION B. General Title V Requirements**

- (i) Three years after the date on which a regulated substance is first listed under § 68.130; or,
 - (ii) The date on which a regulated substance is first present above a threshold quantity in a process.
- (2) The permittee shall submit any additional relevant information requested by the Department or EPA concerning the RMP and shall make subsequent submissions of RMPs in accordance with 40 CFR § 68.190.
- (3) The permittee shall certify that the RMP is accurate and complete in accordance with the requirements of 40 CFR Part 68, including a checklist addressing the required elements of a complete RMP.
- (c) As used in this permit condition, the term "process" shall be as defined in 40 CFR § 68.3. The term "process" means any activity involving a regulated substance including any use, storage, manufacturing, handling, or on-site movement of such substances or any combination of these activities. For purposes of this definition, any group of vessels that are interconnected, or separate vessels that are located such that a regulated substance could be involved in a potential release, shall be considered a single process.
- (d) If the Title V facility is subject to 40 CFR Part 68, as part of the certification required under this permit, the permittee shall:
- (1) Submit a compliance schedule for satisfying the requirements of 40 CFR Part 68 by the date specified in 40 CFR § 68.10(a); or,
 - (2) Certify that the Title V facility is in compliance with all requirements of 40 CFR Part 68 including the registration and submission of the RMP.
- (e) If the Title V facility is subject to 40 CFR Part 68, the permittee shall maintain records supporting the implementation of an accidental release program for five (5) years in accordance with 40 CFR § 68.200.
- (f) When the Title V facility is subject to the accidental release program requirements of Section 112(r) of the Clean Air Act and 40 CFR Part 68, appropriate enforcement action will be taken by the Department if:
- (1) The permittee fails to register and submit the RMP or a revised plan pursuant to 40 CFR Part 68.
 - (2) The permittee fails to submit a compliance schedule or include a statement in the compliance certification required under Section B, Condition #026 of this permit that the Title V facility is in compliance with the requirements of Section 112(r) of the Clean Air Act, 40 CFR Part 68, and 25 Pa. Code § 127.512(i).

#029 [25 Pa. Code § 127.512(e)]**Approved Economic Incentives and Emission Trading Programs**

No permit revision shall be required under approved economic incentives, marketable permits, emissions trading and other similar programs or processes for changes that are provided for in this Title V permit.

#030 [25 Pa. Code §§ 127.516, 127.450(d), 127.449(f) & 127.462(g)]**Permit Shield**

(a) The permittee's compliance with the conditions of this permit shall be deemed in compliance with applicable requirements (as defined in 25 Pa. Code § 121.1) as of the date of permit issuance if either of the following applies:

- (1) The applicable requirements are included and are specifically identified in this permit.
- (2) The Department specifically identifies in the permit other requirements that are not applicable to the permitted facility or source.

(b) Nothing in 25 Pa. Code § 127.516 or the Title V permit shall alter or affect the following:

- (1) The provisions of Section 303 of the Clean Air Act, including the authority of the Administrator of the EPA provided thereunder.
- (2) The liability of the permittee for a violation of an applicable requirement prior to the time of permit issuance.

**SECTION B. General Title V Requirements**

(3) The applicable requirements of the acid rain program, consistent with Section 408(a) of the Clean Air Act.

(4) The ability of the EPA to obtain information from the permittee under Section 114 of the Clean Air Act.

(c) Unless precluded by the Clean Air Act or regulations thereunder, final action by the Department incorporating a significant permit modification in this Title V Permit shall be covered by the permit shield at the time that the permit containing the significant modification is issued.

#031 [25 Pa. Code §135.3]**Reporting**

(a) The permittee shall submit by March 1 of each year an annual emissions report for the preceding calendar year. The report shall include information for all active previously reported sources, new sources which were first operated during the preceding calendar year, and sources modified during the same period which were not previously reported. All air emissions from the facility should be estimated and reported.

(b) A source owner or operator may request an extension of time from the Department for the filing of an annual emissions report, and the Department may grant the extension for reasonable cause.

#032 [25 Pa. Code §135.4]**Report Format**

Emissions reports shall contain sufficient information to enable the Department to complete its emission inventory. Emissions reports shall be made by the source owner or operator in a format specified by the Department.

**SECTION C. Site Level Requirements****I. RESTRICTIONS.****Emission Restriction(s).****# 001 [25 Pa. Code §123.1]****Prohibition of certain fugitive emissions**

a. No person may permit the emission into the outdoor atmosphere of fugitive air contaminants from a source other than the following:

1. Construction or demolition of buildings or structures.
2. Grading, paving and maintenance of roads and streets.
3. Use of roads and streets. Emissions from material in or on trucks, railroad cars and other vehicular equipment are not considered as emissions from use of roads and streets.
4. Clearing of land.
5. Stockpiling of materials.

b. Sources and classes of sources other than those identified in paragraphs (a) - (e), for which the operator has obtained a determination from the Department in accordance with 25 Pa. Code Section 123.1(b) that fugitive emissions from the source, after appropriate control, meet the following requirements:

1. The emissions are of minor significance with respect to causing air pollution; and
2. The emissions are not preventing or interfering with the attainment or maintenance of any ambient air quality standard.

002 [25 Pa. Code §123.2]**Fugitive particulate matter**

No person shall permit fugitive particulate matter to be emitted into the outdoor atmosphere from a source specified in the preceding permit Condition #001, Section C, if such emissions are visible at the point the emissions pass outside the person's property.

003 [25 Pa. Code §123.31]**Limitations**

No person shall emit any malodorous air contaminants into the outdoor atmosphere from any source in such a manner that the malodors are detectable outside the property of the person on whose land the source is being operated.

004 [25 Pa. Code §123.41]**Limitations**

No person shall emit visible air contaminants into the outdoor atmosphere in such a manner that the opacity of the emission is either of the following unless otherwise stated in this permit:

- a. Equal to or greater than 20 percent for a period or periods aggregating more than three minutes in any one hour.
- b. Equal to or greater than 60 percent at any time.

005 [25 Pa. Code §127.441]**Operating permit terms and conditions.**

The permittee shall limit the emissions from the sources within this permit to less than 80.1 tons of nitrogen oxides (NO_x) as NO₂ during any consecutive 12-month period.

**SECTION C. Site Level Requirements****# 006 [25 Pa. Code §127.441]****Operating permit terms and conditions.**

[Additional authority for this condition is derived from Plan Approval 06-05069Q]

The permittee shall limit the total facility volatile organic compound emissions to the outdoor atmosphere from the various concasting operations to 13.52 tons during any consecutive 12-month period. The permittee shall maintain a record of the volatile organic compound emissions from the various concasters at the facility.

II. TESTING REQUIREMENTS.**# 007 [25 Pa. Code §123.43]****Measuring techniques**

Visible emissions may be measured by using either of the following:

- a. A device approved by the Department and maintained to provide accurate opacity measurements.
- b. Observers, trained and qualified to measure plume opacity with the naked eye or with the aid of any devices approved by the Department.

008 [25 Pa. Code §127.441]**Operating permit terms and conditions.**

[Additional authority for parts of this condition are derived from 40 CFR Part, Subpart KK, NSPS]

The permittee shall use the following test methods to determine compliance with the various emission limits unless another test method is approved by the Department:

- a. Particulate - US EPA Method 5 as found in 40 CFR Part 60.
- b. Sulfuric Acid Mist - US EPA Method 8 as found in 40 CFR Part 60.
- c. Lead - US EPA Method 12 as found in 40 CFR Part 60.
- d. Volatile Organic Compounds from the Concaster Wheel - Alcoa Field Test Method 1470-94/ Alcoa Laboratory Analysis Method 1471-94.
- e. Visible Emissions - US EPA Method 9 as found in 40 CFR Part 60 or US EPA Method 22 as found in 40 CFR Part 60.

009 [25 Pa. Code §127.441]**Operating permit terms and conditions.**

The Department reserves the right to require exhaust stack testing of any source as necessary during the permit term to verify emissions for purposes including emission fees, malfunctions or permit condition violations.

010 [25 Pa. Code §127.441]**Operating permit terms and conditions.**

Upon the request of the Department, the permittee shall provide adequate sampling ports, safe sampling platforms and adequate utilities for the performance by the Department of tests on such source. The Department will set forth, in the request, the time period in which the facilities shall be provided as well as the specifications for such facilities.

011 [25 Pa. Code §127.441]**Operating permit terms and conditions.**

For any testing the permittee shall do the following:

- a. Pursuant to 25 Pa. Code Section 139.3 at least 90 calendar days prior to commencing an emissions testing program, a test protocol shall be submitted to the Department for review and approval. The test protocol shall meet all applicable requirements specified in the most current version of the Department's Source Testing Manual.

**SECTION C. Site Level Requirements**

- b. Pursuant to 25 Pa. Code Section 139.3 at least 15 calendar days prior to commencing an emission testing program, notification as to the date and time of testing shall be given to the appropriate Regional Office. Notification shall also be sent to the Division of Source Testing and Monitoring. Notification shall not be made without prior receipt of a protocol acceptance letter from the Department.
- c. Pursuant to 25 Pa. Code Section 139.53(a)(3) within 15 calendar days after completion of the on-site testing portion of an emission test program, if a complete test report has not yet been submitted, an electronic mail notification shall be sent to the Department's Division of Source Testing and Monitoring and the appropriate Regional Office indicating the completion date of the on-site testing.
- d. Pursuant to 40 CFR Part 60.8(a), 40 CFR Part 61.13(f) and 40 CFR Part 63.7(g) a complete test report shall be submitted to the Department no later than 60 calendar days after completion of the on-site testing portion of an emission test program. For those tests being conducted pursuant to 40 CFR Part 61, a complete test report shall be submitted within 31 days after completion of the test
- e. Pursuant to 25 Pa. Code Section 139.53(b) a complete test report shall include a summary of the emission results on the first page of the report indicating if each pollutant measured is within permitted limits and a statement of compliance or non-compliance with all applicable permit conditions. The summary results will include, at a minimum, the following information:
1. A statement that the owner or operator has reviewed the report from the emissions testing body and agrees with the findings.
 2. Permit number(s) and condition(s) which are the basis for the evaluation.
 3. Summary of results with respect to each applicable permit condition.
 4. Statement of compliance or non-compliance with each applicable permit condition.
- f. Pursuant to 25 Pa. Code Section 139.3 all submittals shall meet all applicable requirements specified in the most current version of the Department's Source Testing Manual.
- g. All testing shall be performed in accordance with the provisions of Chapter 139 of the Rules and Regulations of the Department of Environmental Protection.
- (h) Pursuant to 25 Pa. Code Section 139.53(a)(1) and 139.53(a)(3) all submittals, besides notifications, shall be accomplished through PSIMS*Online available through <https://www.depgreenport.state.pa.us/ecommm/Login.jsp> when it becomes available. If internet submittal cannot be accomplished, one digital copy of each submittal shall be made to each of the following:
- Regional Office:
Digital copy: RA-epscstacktesting@pa.gov
- Bureau of Air Quality:
Digital copy: RA-epstacktesting@pa.gov
- (h)(1) A complete paper copy of each submittal shall be made to PA DEP, Bureau of Air Quality, Division of Source Testing and Monitoring, 400 Market Street, 12th Floor Rachael Carson State Office Building, Harrisburg, PA 17105-8468
- (h)(2) A paper copy of (only) the cover letter/page (for both protocols and reports) and summary table (for reports only), of each submittal shall be made to Program Manager, Air Quality Program, PA DEP Southcentral Regional Office, 909 Elmerton Avenue, Harrisburg, PA 17110
- (i) The permittee shall ensure all federal reporting requirements contained in the applicable subpart of 40 CFR are followed, including timelines more stringent than those contained herein. In the event of an inconsistency or any conflicting requirements between state and the federal, the most stringent provision, term, condition, method or rule shall be used by default.

**SECTION C. Site Level Requirements****III. MONITORING REQUIREMENTS.****# 012 [25 Pa. Code §127.441]****Operating permit terms and conditions.**

90% MONITORING CONDITION:

For any monitoring which references this condition, the permittee shall ensure that the monitoring is conducted for at least 90% of the assigned intervals during any 6-month reporting period. The permittee shall keep records sufficient to demonstrate compliance with this condition.

013 [25 Pa. Code §127.441]**Operating permit terms and conditions.**

The permittee shall conduct periodic inspections around the facility periphery during the daylight hours when the facility is in production to detect visible emissions, fugitive emissions and malodors as follows:

- a. Visible emissions in excess of the limits stated in condition #004, Section C or any other limits specifically stated in this permit. Visible emissions may be measured according to the methods specified in Condition #007, Section C. As an alternative, facility personnel who observe such visible emissions shall report each incident to the department within two hours of each occurrence and make arrangements for a certified observer to read the visible emissions.
- b. Presence of visible fugitive emissions and fugitive particulate matter beyond the plant boundaries, as stated in Condition #002, Section C.
- c. Presence of odors beyond the facility property boundaries that have the potential to be malodorous as stated in Condition #003, section C.
- d. The frequency of these inspections shall be weekly, except as provided in the Section C 90% Monitoring Condition.

IV. RECORDKEEPING REQUIREMENTS.**# 014 [25 Pa. Code §127.441]****Operating permit terms and conditions.**

The permittee shall record the results of the weekly inspections around the facility on the approved check sheets. The check sheets shall be made available to the Department upon request.

015 [25 Pa. Code §127.441]**Operating permit terms and conditions.**

[Additional authority for this condition is derived from 25 Pa Code Section 129.91, RACT]

The permittee shall maintain sufficient records so that monthly and 12-month rolling total emissions of the items listed below from the facility's sources can be maintained.

For the purpose of Prevention of Significant Deterioration (PSD), New Source Review (NSR), Reasonably Available Control Technology (RACT) and any other applicable federal or state air quality program, the permittee shall maintain the above 12-month rolling total of the below emissions from the battery assembly facility sources and a combined total emissions of the battery assembly facility and the adjacent smelter:

- a. PM-10 (minus sulfuric acid mist)
- b. PM-2.5 (minus sulfuric acid mist)
- c. Nitrogen Oxides (NO_x)
- d. Sulfur Oxides (SO_x)
- e. Carbon Monoxide (CO)
- f. Volatile Organic Compounds (VOC)
- g. Lead (Pb)
- h. Sulfuric Acid Mist (H₂SO₄)

Note: These emissions shall be calculated using methods and/or emission factors approved by the Department or

**SECTION C. Site Level Requirements**

certified continuous emission monitors. Sulfuric Acid Mist (H₂SO₄) shall be reported as particulate from all sources at the smelter, while all assembly source shall report the acid mists as mist and not particulate.

016 [25 Pa. Code §127.441]**Operating permit terms and conditions.**

[Additional authority for this condition is derived from 25 Pa Code Section 129.91, RACT]

The permittee shall maintain permanent records of the fuel consumption on a monthly basis in a method approved by the Department. The records shall contain the following minimum information:

- a. Monthly fuel consumption
- b. Type of fuel
- c. Heating value of each fuel used in BTUs
- d. Monthly fuel consumption in BTUs
- e. 12-month rolling total of BTUs fired

017 [25 Pa. Code §127.441]**Operating permit terms and conditions.**

The permittee shall maintain an inventory of all process related emission points for each battery assembly plant and the oxide plant. This inventory shall be updated, at a minimum, once every calendar quarter. The inventory shall be submitted to the Department in conjunction with the AIMS submission. The inventory shall include each source, air pollution control device and stack.

V. REPORTING REQUIREMENTS.**# 018 [25 Pa. Code §127.511]****Monitoring and related recordkeeping and reporting requirements.**

The permittee shall report malfunctions to the Department. A malfunction is any sudden, infrequent, and not reasonably preventable failure of air pollution control equipment, process equipment, or a process to operate in a normal or usual manner that affects the facility's ability to comply with a permit term. Failures that are caused in part by poor maintenance or careless operation are not malfunctions. Malfunctions shall be reported as follows:

(a) Malfunctions which pose an imminent danger to public health, safety, welfare and the environment, shall be immediately reported to the Department by telephone. The telephone report of such malfunctions shall occur no later than two hours after discovery of the incident. Telephone reports can be made to the Reading District Office at (610) 916-0100 during normal business hours, or to the Department's Emergency Hotline at any time. The Emergency Hotline phone number is changed/updated periodically. The current Emergency Hotline phone number can be found at <https://www.dep.pa.gov/About/Regional/SouthcentralRegion/Pages/default.aspx>. The permittee shall submit a written report of instances of such malfunctions to the Department within three (3) days of the telephone report.

(b) Unless otherwise approved by DEP, all malfunctions shall be reported through the Department's Greenport PUP system available through: <https://greenport.pa.gov/ePermitPublicAccess/PublicSubmission/Home>

VI. WORK PRACTICE REQUIREMENTS.**# 019 [25 Pa. Code §123.1]****Prohibition of certain fugitive emissions**

The permittee shall take all reasonable actions to prevent particulate matter from the sources identified in Condition #001, Section C from becoming airborne. These actions shall include, but not be limited to, the following:

- a. Use, where possible, of water or chemicals for control of dust in the demolition of buildings or structures, construction operations, the grading of roads or the clearing of land.
- b. Application of asphalt, oil, water or suitable chemicals on dirt roads, material stockpiles and other surfaces which may

**SECTION C. Site Level Requirements**

give rise to airborne dusts.

c. Paving and maintenance of roadways.

d. Prompt removal of earth or other material from paved streets onto which earth or other material has been transported by trucking or earth moving equipment, erosion by water or other means.

020 [25 Pa. Code §127.441]**Operating permit terms and conditions.**

[Additional authority for this condition is derived from 25 PA Code Section 129.91, RACT]

The permittee shall operate all of the sources which include combustion of fuel in accordance with good air pollution control practice (e.g. operating sources in accordance with manufacturer specifications and preventative maintenance requirements) to limit the NO_x, CO and VOC emissions.

021 [25 Pa. Code §127.441]**Operating permit terms and conditions.**

CAM RANGE CONDITION:

Should any daily, weekly or quarterly pressure drop readings or visible emission readings deviate from the normal range or limit, the permittee shall record the incident and take corrective actions. All corrective actions shall be recorded.

The normal operational pressure drop ranges of each type of control device operated at EPMs Lyon Station, PA Battery Manufacturing Facility equipped with a pressure differential monitoring device are as follows:

Fabric filter dust collector - 0.1 to 10 inches of water.

Mist eliminator - 0.1 to 6 inches of water.

HEPA filter - 0.1 to 6 inches of water.

Fiber bed filter - 0.1 to 15 inches of water.

022 [25 Pa. Code §127.441]**Operating permit terms and conditions.**

[Additional authority for this condition is derived from 25 Pa Code Section 129.91, RACT]

The permittee shall maintain each air pollution control device as identified in the source inventory to control emissions from the associated source. Nevertheless, if a baghouse goes down, the permittee may finish out the operation of the process for that shift, provided that the building housing the process remains under negative pressure. The permittee shall keep adequate records to demonstrate compliance with this condition.

023 [25 Pa. Code §127.441]**Operating permit terms and conditions.**

Equipment (a differential manometer or equivalent, as approved by the Department), shall be provided and maintained so that at any time the pressure drop across each particulate, H₂SO₄ and/or lead control device can be measured.

VII. ADDITIONAL REQUIREMENTS.**# 024 [25 Pa. Code §123.42]****Exceptions**

The limitations of 25 Pa. Code Section 123.41 (relating to limitations) do not apply to a visible emission in any of the following instances:

a. When the presence of uncombined water is the only reason for failure of the emission to meet the limitations.

**SECTION C. Site Level Requirements**

b. When the emission results from the operation of equipment used solely to train and test persons in observing the opacity of visible emissions.

c. When the emission results from sources specified in Condition #001, Section C (relating to prohibition of certain fugitive emissions).

025 [25 Pa. Code §127.208]**ERC use and transfer requirements.**

(a) In accordance with 25 PA Code Section 127.208(2) the Department authorizes the transfer and use of 47 tons of NOx Emission Reduction Credits (ERC's) for offset purposes from Anew Environmental, LLC to East Penn Manufacturing Company, Inc. The 47 tpy of NOx ERCs were generated from the shutdown of a source at the Team Ten facility in Tyrone Borough, Blair County, Pennsylvania. The Department certified and registered the 47 tpy of NOx ERCs.

(b) In accordance with 25 PA Code Section 127.208(2), the 47 tons per year of NOx ERCs are no longer subject to the ten year expiration date under Section 127.206(f) except as specified in Section 127.206(g). If the NOx ERCs are not used and are subsequently re-entered into the ERC registry, the applicable ten-year expiration date will not be extended.

[Additional authority for this permit condition is derived from PA 06-05069AD]

026 [25 Pa. Code §127.208]**ERC use and transfer requirements.**

In Plan Approval 06-05069W, in accordance with 25 PA Code §127.208(2) the Department authorized the transfer and use of 59.46 tons of NOx Emission Reduction Credits (ERCs) for offset purposes from Kelman Bottles, LLC (formerly known as Port Glenshaw Glass, LLC) to East Penn Manufacturing Co., Inc.

The 59.46 tons of NOx ERCs previously registered to Kelman Bottles, LLC (formerly known as Port Glenshaw Glass, LLC) were generated from the shutdown of sources at the Port Glenshaw Manufacturing Facility located in Allegheny County, Pennsylvania, on November 24, 2004. The Department certified and registered the 59.46 tons of NOx ERCs on January 24, 2006.

On November 13, 2014, the offsetting NOx ERCs were approved for use by East Penn Manufacturing Co., Inc. in removing the fuel consumption limit of 1,090,000 million Btu during any consecutive 12-month period from Section C, Condition #005 of Title V Operating Permit No. 06-05069. This approval was in accordance with the requirements of 25 PA Code Chapter 127, Subpart E (relating to New Source Review) including 127.205(4) and 127.210.

In accordance with 25 PA Code Section 127.208(2), the 59.46 tons per year of NOx ERCs are no longer subject to the ten-year expiration date under Section 127.206(f) except as specified in Section 127.206(g). If the NOx ERCs are not used and are subsequently re-entered into the ERC registry, the applicable ten-year expiration date will not be extended.

027 [25 Pa. Code §127.208]**ERC use and transfer requirements.**

In Plan Approval 06-05069S, in accordance with 25 PA Code Section 127.208(2) the Department authorized the transfer and use of 53 tons of NOx Emission Reduction Credits (ERC's) for offset purposes from GenOn Energy REMA, LLC (a.k.a. Reliant Energy Mid-Atlantic Power Holdings, LLC) to East Penn Manufacturing Company, Inc.

The 53 tpy of NOx ERCs previously registered to GenOn Energy REMA, LLC were generated from the shutdown of sources at the Warren Generating Station in Warren County, Pennsylvania on September 29, 2002. The Department certified and registered the 53 tpy of NOx ERCs on July 26, 2006.

On September 12, 2012, the offsetting NOx ERC's were approved for use by East Penn Manufacturing Company, Inc. in upgrading formation operations in their A-3 facility. This approval was in accordance with the requirements of 25 PA Code Chapter 127, Subpart E (relating to New Source Review) including 127.205(4) and 127.210.

**SECTION C. Site Level Requirements**

In accordance with 25 PA Code Section 127.208(2), the 53 tons per year of NO_x ERC's are no longer subject to the ten-year expiration date under Section 127.206(f) except as specified in Section 127.206(g). If the NO_x ERC's are not used and are subsequently re-entered into the ERC registry, the applicable ten-year expiration date will not be extended.

028 [25 Pa. Code §127.441]**Operating permit terms and conditions.**

[Additional authority for this condition is derived from 40 CFR Part 60, Subpart KK, NSPS]

For those control devices that have multiple sources being exhausted to them with multiple emission limits, the allowable emission limit shall be determined by using the air volume weighted averaging method as found in 40 CFR Part 60, Section 60.372(b).

$$Se = \text{SUM} (1 \text{ through } N) Sa * (Qsda / Q sdt)$$

Where:

Se = The equivalent standard for the total exhaust stream.

Sa = The actual standard for each exhaust stream ducted to the common control device.

N = The total number of exhaust streams ducted to the common control device.

Qsda = The dry standard volumetric flow rate of the effluent gas stream from each source ducted to the common control device.

Qsdt = The total dry standard volumetric flow rate of all effluent gas streams ducted to the common control device.

029 [25 Pa. Code §127.441]**Operating permit terms and conditions.**

(a) This Title V Operating Permit incorporates by reference all of the provisions of Plan Approval 06-05069AF. Based on this incorporation, any violation of the plan approval would also be deemed a violation of this Title V Operating Permit.

(b) This incorporation of Plan Approval 06-05069AF into this Title V Operating Permit shall not be construed to require the permittee to implement the projects that are the subject of the plan approval, unless an enforcement action, regulation or statute independently requires otherwise.

(c) This Title V permit shall not be construed to provide any independent, ongoing authority for the construction or operation of the project that is the subject of Plan Approval 06-05069AF unless and until the permittee applies for, and is granted, future administrative amendment(s) to this Title V permit for the project. Application for an administrative amendment would occur after the plan approval equipment has been determined by DEP to have completed its temporary operation phase under the authority of the plan approval.

030 [25 Pa. Code §127.441]**Operating permit terms and conditions.**

The permittee shall submit within thirty days of 01/01/2027 a certificate of compliance with all permit terms and conditions set forth in this Title V permit as required under condition #024 of section B of this permit, and annually thereafter.

031 [25 Pa. Code §129.14]**Open burning operations**

a. No person shall conduct open burning of materials in such a manner that:

1. The emissions are visible, at any time, at the point such emissions pass outside the property of the person on whose land the open burning is being conducted.

2. Malodorous air contaminants from the open burning are detectable outside the property of the person on whose land



SECTION C. Site Level Requirements

the open burning is being conducted.

3. The emissions interfere with the reasonable enjoyment of life and property.

4. The emissions cause damage to vegetation or property.

5. The emissions are or may be deleterious to human or animal health.

b. These limits do not apply where the open burning operations result from the following:

1. A fire set to prevent or abate a fire hazard, when approved by the Department and set by or under the supervision of a public officer.

2. Any fire set for the purpose of instructing personnel in fire fighting, when approved by the Department.

3. A fire set for the prevention and control of disease or pests, when approved by the Department.

4. A fire set in conjunction with the production of agricultural commodities in their unmanufactured state on the premises of the farm operation.

5. A fire set solely for recreational or ceremonial purposes.

6. A fire set solely for cooking food.

c. This permit does not constitute authorization to burn solid waste pursuant to Section 610(3) of the Solid Waste Management Act, 35 P. S. Section 6018.610(3), or any other provision of the Solid Waste Management Act.

VIII. COMPLIANCE CERTIFICATION.

No additional compliance certifications exist except as provided in other sections of this permit including Section B (relating to Title V General Requirements).

IX. COMPLIANCE SCHEDULE.

No compliance milestones exist.

***** Permit Shield In Effect *****

**SECTION D. Source Level Requirements**

Source ID: 111

Source Name: A-1 MIXING (SCIEN FC 1) & PASTING (FARR CC 4)

Source Capacity/Throughput: 200.000 Each/HR STORAGE BATTERIES

Conditions for this source occur in the following groups: SG 01 A-1 BATTERY ASSEMBLY
SG12 BAGHOUSE CAM

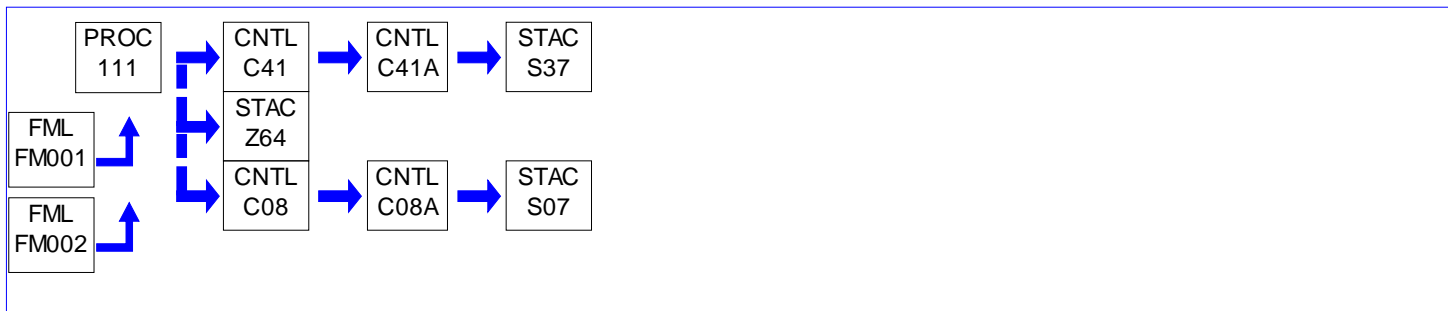
**I. RESTRICTIONS.**

No additional requirements exist except as provided in other sections of this permit including Section B (Title V General Requirements) and/or Section E (Source Group Restrictions).

II. TESTING REQUIREMENTS.

No additional testing requirements exist except as provided in other sections of this permit including Section B (Title V General Requirements) and/or Section E (Source Group Restrictions).

III. MONITORING REQUIREMENTS.

No additional monitoring requirements exist except as provided in other sections of this permit including Section B (Title V General Requirements) and/or Section E (Source Group Restrictions).

IV. RECORDKEEPING REQUIREMENTS.

No additional record keeping requirements exist except as provided in other sections of this permit including Section B (Title V General Requirements) and/or Section E (Source Group Restrictions).

V. REPORTING REQUIREMENTS.

No additional reporting requirements exist except as provided in other sections of this permit including Section B (Title V General Requirements) and/or Section E (Source Group Restrictions).

VI. WORK PRACTICE REQUIREMENTS.

No additional work practice requirements exist except as provided in other sections of this permit including Section B (Title V General Requirements) and/or Section E (Source Group Restrictions).

VII. ADDITIONAL REQUIREMENTS.

No additional requirements exist except as provided in other sections of this permit including Section B (Title V General Requirements) and/or Section E (Source Group Restrictions).

***** Permit Shield in Effect. *****

**SECTION D. Source Level Requirements**

Source ID: 112

Source Name: A-1 DRY CHARGE AREA (SCIEN FC 7, SCIEN FC 6 & FARR CC 4)

Source Capacity/Throughput: 200.000 Each/HR STORAGE BATTERIES

Conditions for this source occur in the following groups: SG 01 A-1 BATTERY ASSEMBLY
SG12 BAGHOUSE CAM

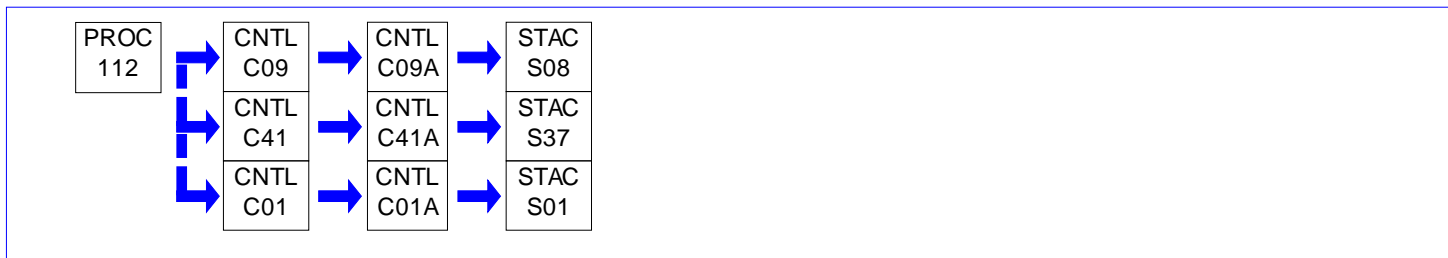
**I. RESTRICTIONS.**

No additional requirements exist except as provided in other sections of this permit including Section B (Title V General Requirements) and/or Section E (Source Group Restrictions).

II. TESTING REQUIREMENTS.

No additional testing requirements exist except as provided in other sections of this permit including Section B (Title V General Requirements) and/or Section E (Source Group Restrictions).

III. MONITORING REQUIREMENTS.

No additional monitoring requirements exist except as provided in other sections of this permit including Section B (Title V General Requirements) and/or Section E (Source Group Restrictions).

IV. RECORDKEEPING REQUIREMENTS.

No additional record keeping requirements exist except as provided in other sections of this permit including Section B (Title V General Requirements) and/or Section E (Source Group Restrictions).

V. REPORTING REQUIREMENTS.

No additional reporting requirements exist except as provided in other sections of this permit including Section B (Title V General Requirements) and/or Section E (Source Group Restrictions).

VI. WORK PRACTICE REQUIREMENTS.

No additional work practice requirements exist except as provided in other sections of this permit including Section B (Title V General Requirements) and/or Section E (Source Group Restrictions).

VII. ADDITIONAL REQUIREMENTS.

No additional requirements exist except as provided in other sections of this permit including Section B (Title V General Requirements) and/or Section E (Source Group Restrictions).

***** Permit Shield in Effect. *****

**SECTION D. Source Level Requirements**

Source ID: 113

Source Name: A-1 GRIDCAST (SCIEN FC 6 & SCIEN FC 5)

Source Capacity/Throughput: 200.000 Each/HR STORAGE BATTERIES

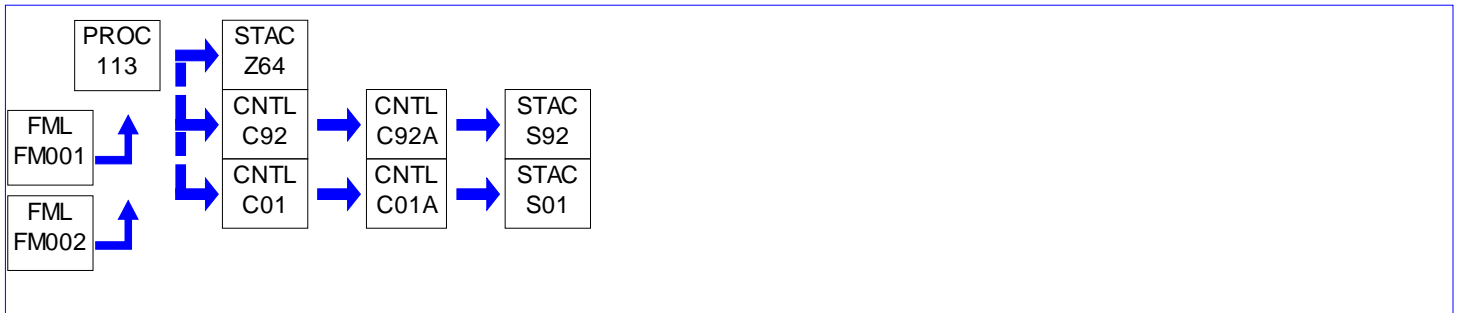
Conditions for this source occur in the following groups: SG 01 A-1 BATTERY ASSEMBLY
SG12 BAGHOUSE CAM**I. RESTRICTIONS.**

No additional requirements exist except as provided in other sections of this permit including Section B (Title V General Requirements) and/or Section E (Source Group Restrictions).

II. TESTING REQUIREMENTS.

No additional testing requirements exist except as provided in other sections of this permit including Section B (Title V General Requirements) and/or Section E (Source Group Restrictions).

III. MONITORING REQUIREMENTS.

No additional monitoring requirements exist except as provided in other sections of this permit including Section B (Title V General Requirements) and/or Section E (Source Group Restrictions).

IV. RECORDKEEPING REQUIREMENTS.

No additional record keeping requirements exist except as provided in other sections of this permit including Section B (Title V General Requirements) and/or Section E (Source Group Restrictions).

V. REPORTING REQUIREMENTS.

No additional reporting requirements exist except as provided in other sections of this permit including Section B (Title V General Requirements) and/or Section E (Source Group Restrictions).

VI. WORK PRACTICE REQUIREMENTS.

No additional work practice requirements exist except as provided in other sections of this permit including Section B (Title V General Requirements) and/or Section E (Source Group Restrictions).

VII. ADDITIONAL REQUIREMENTS.

No additional requirements exist except as provided in other sections of this permit including Section B (Title V General Requirements) and/or Section E (Source Group Restrictions).

***** Permit Shield in Effect. *****

**SECTION D. Source Level Requirements**

Source ID: 114

Source Name: A-1 BATTERY ASSM (FARR CC 4, SCIEN FC 6 & FC 7)

Source Capacity/Throughput: 200.000 Each/HR STORAGE BATTERIES

Conditions for this source occur in the following groups: SG 01 A-1 BATTERY ASSEMBLY
SG12 BAGHOUSE CAM

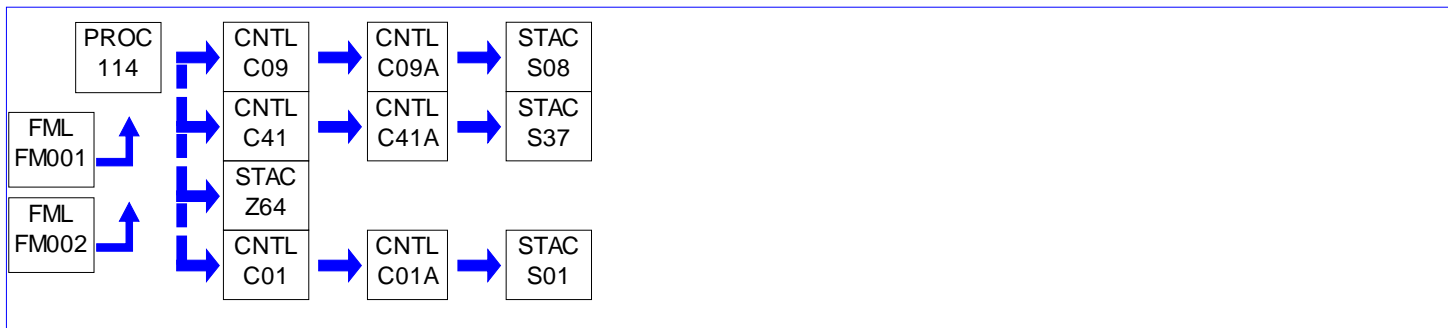
**I. RESTRICTIONS.**

No additional requirements exist except as provided in other sections of this permit including Section B (Title V General Requirements) and/or Section E (Source Group Restrictions).

II. TESTING REQUIREMENTS.

No additional testing requirements exist except as provided in other sections of this permit including Section B (Title V General Requirements) and/or Section E (Source Group Restrictions).

III. MONITORING REQUIREMENTS.

No additional monitoring requirements exist except as provided in other sections of this permit including Section B (Title V General Requirements) and/or Section E (Source Group Restrictions).

IV. RECORDKEEPING REQUIREMENTS.

No additional record keeping requirements exist except as provided in other sections of this permit including Section B (Title V General Requirements) and/or Section E (Source Group Restrictions).

V. REPORTING REQUIREMENTS.

No additional reporting requirements exist except as provided in other sections of this permit including Section B (Title V General Requirements) and/or Section E (Source Group Restrictions).

VI. WORK PRACTICE REQUIREMENTS.

No additional work practice requirements exist except as provided in other sections of this permit including Section B (Title V General Requirements) and/or Section E (Source Group Restrictions).

VII. ADDITIONAL REQUIREMENTS.

No additional requirements exist except as provided in other sections of this permit including Section B (Title V General Requirements) and/or Section E (Source Group Restrictions).

*** Permit Shield in Effect. ***

**SECTION D. Source Level Requirements**

Source ID: 116A

Source Name: A-1 LEAD OXIDE STORAGE SILOS (2) (BIN VENTS)

Source Capacity/Throughput:

Conditions for this source occur in the following groups: SG 01 A-1 BATTERY ASSEMBLY

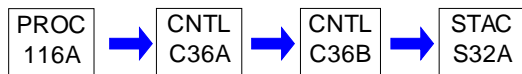
**I. RESTRICTIONS.**

No additional requirements exist except as provided in other sections of this permit including Section B (Title V General Requirements) and/or Section E (Source Group Restrictions).

II. TESTING REQUIREMENTS.

No additional testing requirements exist except as provided in other sections of this permit including Section B (Title V General Requirements) and/or Section E (Source Group Restrictions).

III. MONITORING REQUIREMENTS.

No additional monitoring requirements exist except as provided in other sections of this permit including Section B (Title V General Requirements) and/or Section E (Source Group Restrictions).

IV. RECORDKEEPING REQUIREMENTS.

No additional record keeping requirements exist except as provided in other sections of this permit including Section B (Title V General Requirements) and/or Section E (Source Group Restrictions).

V. REPORTING REQUIREMENTS.

No additional reporting requirements exist except as provided in other sections of this permit including Section B (Title V General Requirements) and/or Section E (Source Group Restrictions).

VI. WORK PRACTICE REQUIREMENTS.

No additional work practice requirements exist except as provided in other sections of this permit including Section B (Title V General Requirements) and/or Section E (Source Group Restrictions).

VII. ADDITIONAL REQUIREMENTS.

No additional requirements exist except as provided in other sections of this permit including Section B (Title V General Requirements) and/or Section E (Source Group Restrictions).

***** Permit Shield in Effect. *****

**SECTION D. Source Level Requirements**

Source ID: 126

Source Name: LEAD OXIDE MILL 1

Source Capacity/Throughput:	750.000 CF/HR	NATURAL GAS
	2,600.000 Lbs/HR	LEAD OXIDE

Conditions for this source occur in the following groups: SG 05 OXIDE PLANT

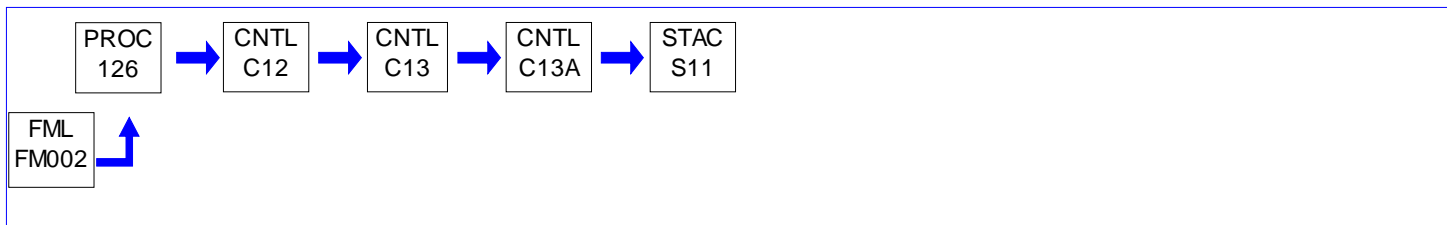
**I. RESTRICTIONS.**

No additional requirements exist except as provided in other sections of this permit including Section B (Title V General Requirements) and/or Section E (Source Group Restrictions).

II. TESTING REQUIREMENTS.

No additional testing requirements exist except as provided in other sections of this permit including Section B (Title V General Requirements) and/or Section E (Source Group Restrictions).

III. MONITORING REQUIREMENTS.

No additional monitoring requirements exist except as provided in other sections of this permit including Section B (Title V General Requirements) and/or Section E (Source Group Restrictions).

IV. RECORDKEEPING REQUIREMENTS.

No additional record keeping requirements exist except as provided in other sections of this permit including Section B (Title V General Requirements) and/or Section E (Source Group Restrictions).

V. REPORTING REQUIREMENTS.

No additional reporting requirements exist except as provided in other sections of this permit including Section B (Title V General Requirements) and/or Section E (Source Group Restrictions).

VI. WORK PRACTICE REQUIREMENTS.

No additional work practice requirements exist except as provided in other sections of this permit including Section B (Title V General Requirements) and/or Section E (Source Group Restrictions).

VII. ADDITIONAL REQUIREMENTS.

No additional requirements exist except as provided in other sections of this permit including Section B (Title V General Requirements) and/or Section E (Source Group Restrictions).

***** Permit Shield in Effect. *****

**SECTION D. Source Level Requirements**

Source ID: 127

Source Name: LEAD OXIDE MILL 3

Source Capacity/Throughput:	750.000 CF/HR	NATURAL GAS
	2,600.000 Lbs/HR	LEAD OXIDE

Conditions for this source occur in the following groups: SG 05 OXIDE PLANT

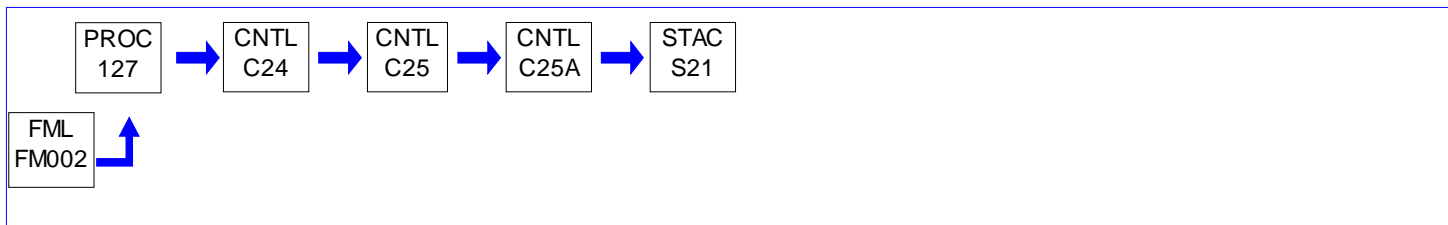
**I. RESTRICTIONS.**

No additional requirements exist except as provided in other sections of this permit including Section B (Title V General Requirements) and/or Section E (Source Group Restrictions).

II. TESTING REQUIREMENTS.

No additional testing requirements exist except as provided in other sections of this permit including Section B (Title V General Requirements) and/or Section E (Source Group Restrictions).

III. MONITORING REQUIREMENTS.

No additional monitoring requirements exist except as provided in other sections of this permit including Section B (Title V General Requirements) and/or Section E (Source Group Restrictions).

IV. RECORDKEEPING REQUIREMENTS.

No additional record keeping requirements exist except as provided in other sections of this permit including Section B (Title V General Requirements) and/or Section E (Source Group Restrictions).

V. REPORTING REQUIREMENTS.

No additional reporting requirements exist except as provided in other sections of this permit including Section B (Title V General Requirements) and/or Section E (Source Group Restrictions).

VI. WORK PRACTICE REQUIREMENTS.

No additional work practice requirements exist except as provided in other sections of this permit including Section B (Title V General Requirements) and/or Section E (Source Group Restrictions).

VII. ADDITIONAL REQUIREMENTS.

No additional requirements exist except as provided in other sections of this permit including Section B (Title V General Requirements) and/or Section E (Source Group Restrictions).

***** Permit Shield in Effect. *****

**SECTION D. Source Level Requirements**

Source ID: 128

Source Name: LEAD OXIDE MILL 2

Source Capacity/Throughput:	750.000 CF/HR	NATURAL GAS
	2,600.000 Lbs/HR	LEAD OXIDE

Conditions for this source occur in the following groups: SG 05 OXIDE PLANT

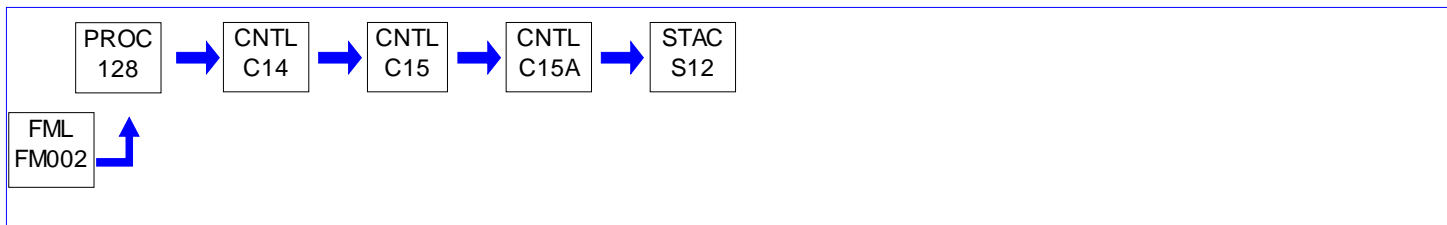
**I. RESTRICTIONS.**

No additional requirements exist except as provided in other sections of this permit including Section B (Title V General Requirements) and/or Section E (Source Group Restrictions).

II. TESTING REQUIREMENTS.

No additional testing requirements exist except as provided in other sections of this permit including Section B (Title V General Requirements) and/or Section E (Source Group Restrictions).

III. MONITORING REQUIREMENTS.

No additional monitoring requirements exist except as provided in other sections of this permit including Section B (Title V General Requirements) and/or Section E (Source Group Restrictions).

IV. RECORDKEEPING REQUIREMENTS.

No additional record keeping requirements exist except as provided in other sections of this permit including Section B (Title V General Requirements) and/or Section E (Source Group Restrictions).

V. REPORTING REQUIREMENTS.

No additional reporting requirements exist except as provided in other sections of this permit including Section B (Title V General Requirements) and/or Section E (Source Group Restrictions).

VI. WORK PRACTICE REQUIREMENTS.

No additional work practice requirements exist except as provided in other sections of this permit including Section B (Title V General Requirements) and/or Section E (Source Group Restrictions).

VII. ADDITIONAL REQUIREMENTS.

No additional requirements exist except as provided in other sections of this permit including Section B (Title V General Requirements) and/or Section E (Source Group Restrictions).

***** Permit Shield in Effect. *****

**SECTION D. Source Level Requirements**

Source ID: 129

Source Name: LEAD OXIDE MILL 4

Source Capacity/Throughput:	750.000 CF/HR	NATURAL GAS
	2,600.000 Lbs/HR	LEAD OXIDE

Conditions for this source occur in the following groups: SG 05 OXIDE PLANT

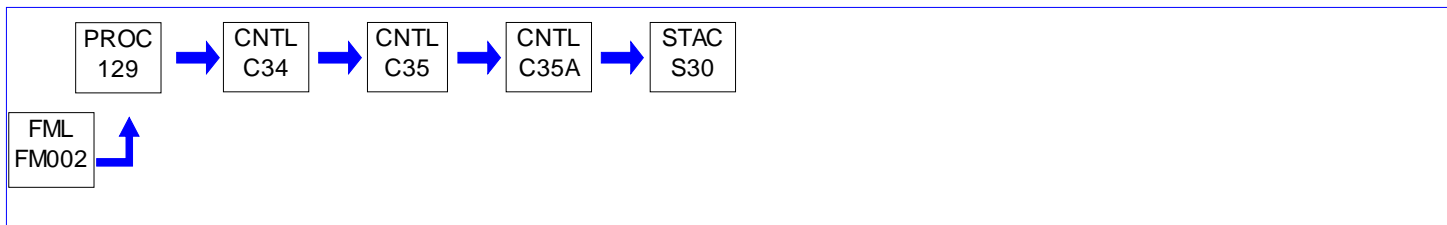
**I. RESTRICTIONS.**

No additional requirements exist except as provided in other sections of this permit including Section B (Title V General Requirements) and/or Section E (Source Group Restrictions).

II. TESTING REQUIREMENTS.

No additional testing requirements exist except as provided in other sections of this permit including Section B (Title V General Requirements) and/or Section E (Source Group Restrictions).

III. MONITORING REQUIREMENTS.

No additional monitoring requirements exist except as provided in other sections of this permit including Section B (Title V General Requirements) and/or Section E (Source Group Restrictions).

IV. RECORDKEEPING REQUIREMENTS.

No additional record keeping requirements exist except as provided in other sections of this permit including Section B (Title V General Requirements) and/or Section E (Source Group Restrictions).

V. REPORTING REQUIREMENTS.

No additional reporting requirements exist except as provided in other sections of this permit including Section B (Title V General Requirements) and/or Section E (Source Group Restrictions).

VI. WORK PRACTICE REQUIREMENTS.

No additional work practice requirements exist except as provided in other sections of this permit including Section B (Title V General Requirements) and/or Section E (Source Group Restrictions).

VII. ADDITIONAL REQUIREMENTS.

No additional requirements exist except as provided in other sections of this permit including Section B (Title V General Requirements) and/or Section E (Source Group Restrictions).

***** Permit Shield in Effect. *****

**SECTION D. Source Level Requirements**

Source ID: 130

Source Name: A-2 BATTERY ASSEMBLY C (SCIENTIFIC FC 2)

Source Capacity/Throughput: 1,100.000 Each/HR STORAGE BATTERIES

Conditions for this source occur in the following groups: SG 02 A-2 BATTERY ASSEMBLY
SG12 BAGHOUSE CAM

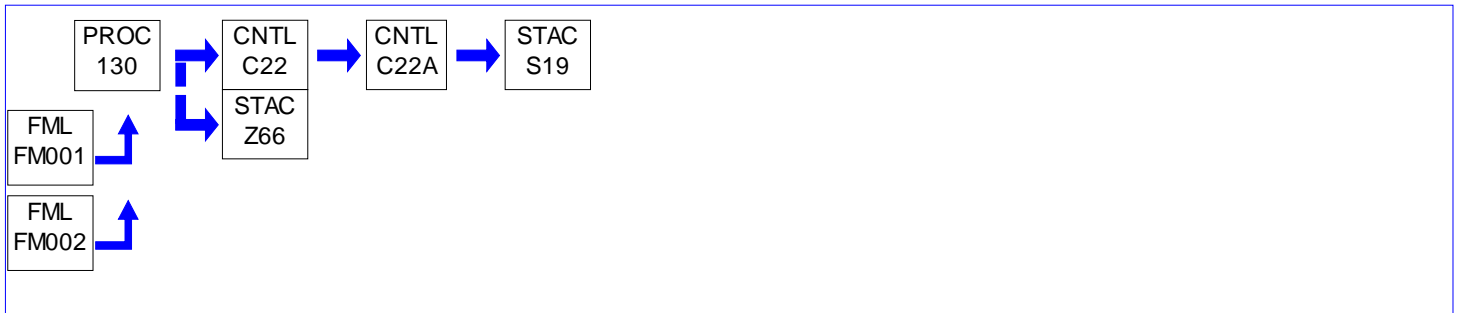
**I. RESTRICTIONS.**

No additional requirements exist except as provided in other sections of this permit including Section B (Title V General Requirements) and/or Section E (Source Group Restrictions).

II. TESTING REQUIREMENTS.

No additional testing requirements exist except as provided in other sections of this permit including Section B (Title V General Requirements) and/or Section E (Source Group Restrictions).

III. MONITORING REQUIREMENTS.

No additional monitoring requirements exist except as provided in other sections of this permit including Section B (Title V General Requirements) and/or Section E (Source Group Restrictions).

IV. RECORDKEEPING REQUIREMENTS.

No additional record keeping requirements exist except as provided in other sections of this permit including Section B (Title V General Requirements) and/or Section E (Source Group Restrictions).

V. REPORTING REQUIREMENTS.

No additional reporting requirements exist except as provided in other sections of this permit including Section B (Title V General Requirements) and/or Section E (Source Group Restrictions).

VI. WORK PRACTICE REQUIREMENTS.

No additional work practice requirements exist except as provided in other sections of this permit including Section B (Title V General Requirements) and/or Section E (Source Group Restrictions).

VII. ADDITIONAL REQUIREMENTS.

No additional requirements exist except as provided in other sections of this permit including Section B (Title V General Requirements) and/or Section E (Source Group Restrictions).

***** Permit Shield in Effect. *****

**SECTION D. Source Level Requirements**

Source ID: 131

Source Name: A-2 MIXING (SCIEN FC 9) & PASTING (SCIEN FC 2 & 6)

Source Capacity/Throughput: 1,100.000 Each/HR STORAGE BATTERIES

Conditions for this source occur in the following groups: SG 02 A-2 BATTERY ASSEMBLY
SG12 BAGHOUSE CAM

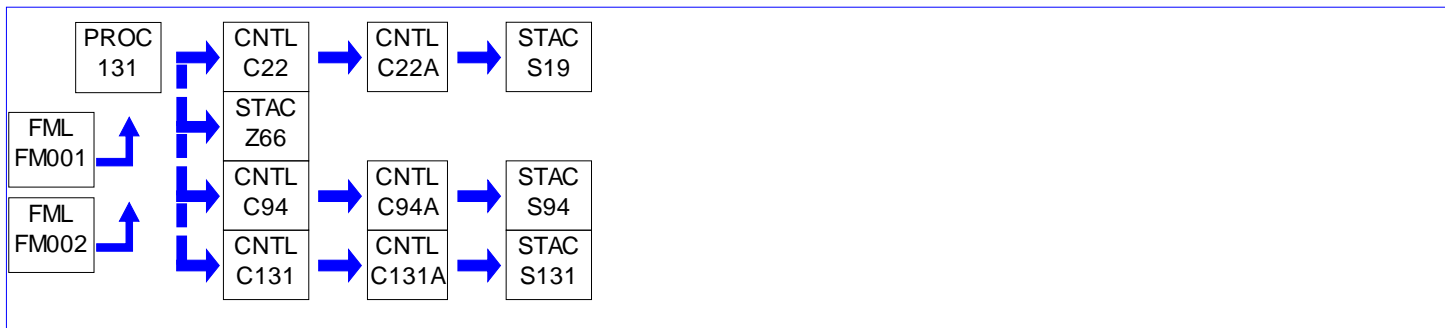
**I. RESTRICTIONS.**

No additional requirements exist except as provided in other sections of this permit including Section B (Title V General Requirements) and/or Section E (Source Group Restrictions).

II. TESTING REQUIREMENTS.

No additional testing requirements exist except as provided in other sections of this permit including Section B (Title V General Requirements) and/or Section E (Source Group Restrictions).

III. MONITORING REQUIREMENTS.

No additional monitoring requirements exist except as provided in other sections of this permit including Section B (Title V General Requirements) and/or Section E (Source Group Restrictions).

IV. RECORDKEEPING REQUIREMENTS.

No additional record keeping requirements exist except as provided in other sections of this permit including Section B (Title V General Requirements) and/or Section E (Source Group Restrictions).

V. REPORTING REQUIREMENTS.

No additional reporting requirements exist except as provided in other sections of this permit including Section B (Title V General Requirements) and/or Section E (Source Group Restrictions).

VI. WORK PRACTICE REQUIREMENTS.

No additional work practice requirements exist except as provided in other sections of this permit including Section B (Title V General Requirements) and/or Section E (Source Group Restrictions).

VII. ADDITIONAL REQUIREMENTS.

No additional requirements exist except as provided in other sections of this permit including Section B (Title V General Requirements) and/or Section E (Source Group Restrictions).

***** Permit Shield in Effect. *****

**SECTION D. Source Level Requirements**

Source ID: 132

Source Name: A-2 COS & ENVELOPE (SCIEN FC 1 & SCIEN FC 10)

Source Capacity/Throughput: 1,100.000 Each/HR STORAGE BATTERIES

Conditions for this source occur in the following groups: SG 02 A-2 BATTERY ASSEMBLY
SG12 BAGHOUSE CAM

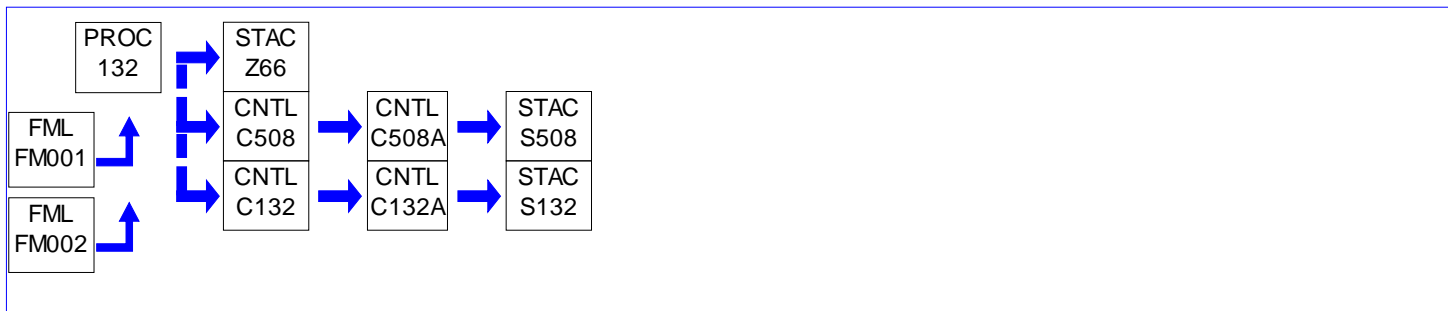
**I. RESTRICTIONS.**

No additional requirements exist except as provided in other sections of this permit including Section B (Title V General Requirements) and/or Section E (Source Group Restrictions).

II. TESTING REQUIREMENTS.

No additional testing requirements exist except as provided in other sections of this permit including Section B (Title V General Requirements) and/or Section E (Source Group Restrictions).

III. MONITORING REQUIREMENTS.

No additional monitoring requirements exist except as provided in other sections of this permit including Section B (Title V General Requirements) and/or Section E (Source Group Restrictions).

IV. RECORDKEEPING REQUIREMENTS.

No additional record keeping requirements exist except as provided in other sections of this permit including Section B (Title V General Requirements) and/or Section E (Source Group Restrictions).

V. REPORTING REQUIREMENTS.

No additional reporting requirements exist except as provided in other sections of this permit including Section B (Title V General Requirements) and/or Section E (Source Group Restrictions).

VI. WORK PRACTICE REQUIREMENTS.

No additional work practice requirements exist except as provided in other sections of this permit including Section B (Title V General Requirements) and/or Section E (Source Group Restrictions).

VII. ADDITIONAL REQUIREMENTS.

No additional requirements exist except as provided in other sections of this permit including Section B (Title V General Requirements) and/or Section E (Source Group Restrictions).

***** Permit Shield in Effect. *****

**SECTION D. Source Level Requirements**

Source ID: 133

Source Name: A-2 GRIDCAST (SCIEN FC 7, 2 &10 & SCIEN FC 1)

Source Capacity/Throughput: 1,100.000 Each/HR STORAGE BATTERIES

Conditions for this source occur in the following groups: SG 02 A-2 BATTERY ASSEMBLY
SG12 BAGHOUSE CAM

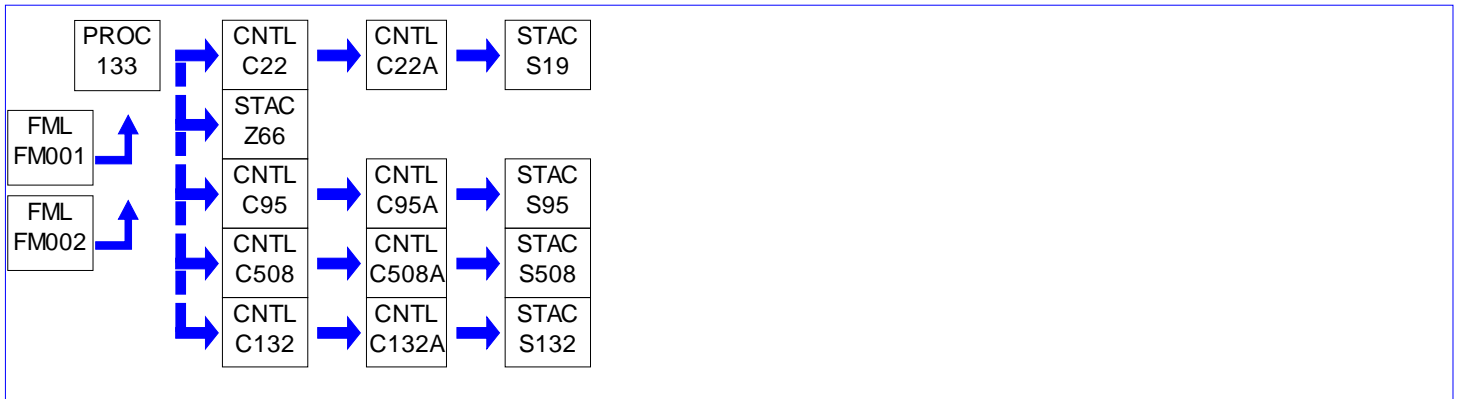
**I. RESTRICTIONS.**

No additional requirements exist except as provided in other sections of this permit including Section B (Title V General Requirements) and/or Section E (Source Group Restrictions).

II. TESTING REQUIREMENTS.

No additional testing requirements exist except as provided in other sections of this permit including Section B (Title V General Requirements) and/or Section E (Source Group Restrictions).

III. MONITORING REQUIREMENTS.

No additional monitoring requirements exist except as provided in other sections of this permit including Section B (Title V General Requirements) and/or Section E (Source Group Restrictions).

IV. RECORDKEEPING REQUIREMENTS.

No additional record keeping requirements exist except as provided in other sections of this permit including Section B (Title V General Requirements) and/or Section E (Source Group Restrictions).

V. REPORTING REQUIREMENTS.

No additional reporting requirements exist except as provided in other sections of this permit including Section B (Title V General Requirements) and/or Section E (Source Group Restrictions).

VI. WORK PRACTICE REQUIREMENTS.

No additional work practice requirements exist except as provided in other sections of this permit including Section B (Title V General Requirements) and/or Section E (Source Group Restrictions).

VII. ADDITIONAL REQUIREMENTS.

No additional requirements exist except as provided in other sections of this permit including Section B (Title V General Requirements) and/or Section E (Source Group Restrictions).



SECTION D. Source Level Requirements

***** Permit Shield in Effect. *****

**SECTION D. Source Level Requirements**

Source ID: 133A

Source Name: A-2 CONCASTER (SCIEN FC #1 & SCIEN FC #10)

Source Capacity/Throughput: 1,100.000 Each/HR STORAGE BATTERIES

Conditions for this source occur in the following groups: SG 02 A-2 BATTERY ASSEMBLY
 SG10B RACT 2
 SG12 BAGHOUSE CAM
 SG20 RACT III PRESUMPTIVE

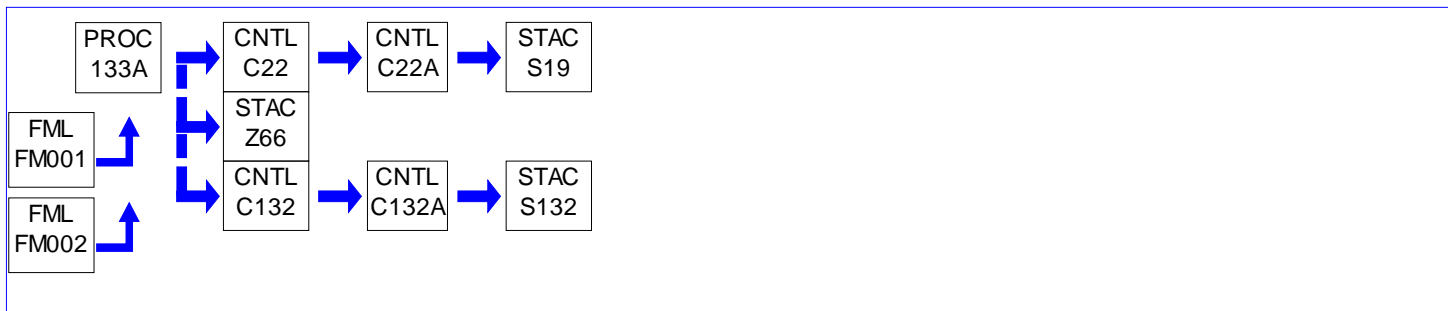
**I. RESTRICTIONS.**

No additional requirements exist except as provided in other sections of this permit including Section B (Title V General Requirements) and/or Section E (Source Group Restrictions).

II. TESTING REQUIREMENTS.

No additional testing requirements exist except as provided in other sections of this permit including Section B (Title V General Requirements) and/or Section E (Source Group Restrictions).

III. MONITORING REQUIREMENTS.

No additional monitoring requirements exist except as provided in other sections of this permit including Section B (Title V General Requirements) and/or Section E (Source Group Restrictions).

IV. RECORDKEEPING REQUIREMENTS.

No additional record keeping requirements exist except as provided in other sections of this permit including Section B (Title V General Requirements) and/or Section E (Source Group Restrictions).

V. REPORTING REQUIREMENTS.

No additional reporting requirements exist except as provided in other sections of this permit including Section B (Title V General Requirements) and/or Section E (Source Group Restrictions).

VI. WORK PRACTICE REQUIREMENTS.

No additional work practice requirements exist except as provided in other sections of this permit including Section B (Title V General Requirements) and/or Section E (Source Group Restrictions).

VII. ADDITIONAL REQUIREMENTS.

No additional requirements exist except as provided in other sections of this permit including Section B (Title V General Requirements) and/or Section E (Source Group Restrictions).



SECTION D. Source Level Requirements

***** Permit Shield in Effect. *****

**SECTION D. Source Level Requirements**

Source ID: 133E

Source Name: A-2 STRIP/PUNCHCAST MACH #1-3 (SCIEN FC 1)

Source Capacity/Throughput:

Conditions for this source occur in the following groups: SG 02 A-2 BATTERY ASSEMBLY
SG12 BAGHOUSE CAM

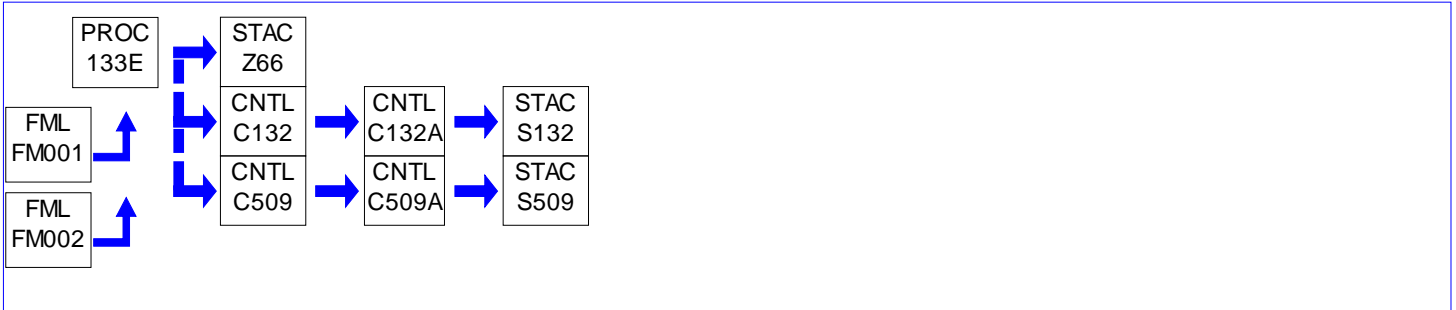
**I. RESTRICTIONS.**

No additional requirements exist except as provided in other sections of this permit including Section B (Title V General Requirements) and/or Section E (Source Group Restrictions).

II. TESTING REQUIREMENTS.

No additional testing requirements exist except as provided in other sections of this permit including Section B (Title V General Requirements) and/or Section E (Source Group Restrictions).

III. MONITORING REQUIREMENTS.

No additional monitoring requirements exist except as provided in other sections of this permit including Section B (Title V General Requirements) and/or Section E (Source Group Restrictions).

IV. RECORDKEEPING REQUIREMENTS.

No additional record keeping requirements exist except as provided in other sections of this permit including Section B (Title V General Requirements) and/or Section E (Source Group Restrictions).

V. REPORTING REQUIREMENTS.

No additional reporting requirements exist except as provided in other sections of this permit including Section B (Title V General Requirements) and/or Section E (Source Group Restrictions).

VI. WORK PRACTICE REQUIREMENTS.

No additional work practice requirements exist except as provided in other sections of this permit including Section B (Title V General Requirements) and/or Section E (Source Group Restrictions).

VII. ADDITIONAL REQUIREMENTS.

No additional requirements exist except as provided in other sections of this permit including Section B (Title V General Requirements) and/or Section E (Source Group Restrictions).

***** Permit Shield in Effect. *****



SECTION D. Source Level Requirements

Source ID: 134

Source Name: A-2 ASSEMBLY (SCIENTIFIC FC 8)

Source Capacity/Throughput: 1,100.000 Each/HR STORAGE BATTERIES

Conditions for this source occur in the following groups: SG 02 A-2 BATTERY ASSEMBLY
SG12 BAGHOUSE CAM



I. RESTRICTIONS.

No additional requirements exist except as provided in other sections of this permit including Section B (Title V General Requirements) and/or Section E (Source Group Restrictions).

II. TESTING REQUIREMENTS.

No additional testing requirements exist except as provided in other sections of this permit including Section B (Title V General Requirements) and/or Section E (Source Group Restrictions).

III. MONITORING REQUIREMENTS.

No additional monitoring requirements exist except as provided in other sections of this permit including Section B (Title V General Requirements) and/or Section E (Source Group Restrictions).

IV. RECORDKEEPING REQUIREMENTS.

No additional record keeping requirements exist except as provided in other sections of this permit including Section B (Title V General Requirements) and/or Section E (Source Group Restrictions).

V. REPORTING REQUIREMENTS.

No additional reporting requirements exist except as provided in other sections of this permit including Section B (Title V General Requirements) and/or Section E (Source Group Restrictions).

VI. WORK PRACTICE REQUIREMENTS.

No additional work practice requirements exist except as provided in other sections of this permit including Section B (Title V General Requirements) and/or Section E (Source Group Restrictions).

VII. ADDITIONAL REQUIREMENTS.

No additional requirements exist except as provided in other sections of this permit including Section B (Title V General Requirements) and/or Section E (Source Group Restrictions).

***** Permit Shield in Effect. *****

**SECTION D. Source Level Requirements**

Source ID: 135

Source Name: IND LEAD OXIDE RECEIVING TANK (3) (BIN VENT)

Source Capacity/Throughput:

Conditions for this source occur in the following groups: SG 04 IND BATTERY ASSEMBLY

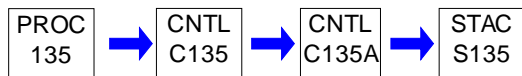
**I. RESTRICTIONS.**

No additional requirements exist except as provided in other sections of this permit including Section B (Title V General Requirements) and/or Section E (Source Group Restrictions).

II. TESTING REQUIREMENTS.

No additional testing requirements exist except as provided in other sections of this permit including Section B (Title V General Requirements) and/or Section E (Source Group Restrictions).

III. MONITORING REQUIREMENTS.

No additional monitoring requirements exist except as provided in other sections of this permit including Section B (Title V General Requirements) and/or Section E (Source Group Restrictions).

IV. RECORDKEEPING REQUIREMENTS.

No additional record keeping requirements exist except as provided in other sections of this permit including Section B (Title V General Requirements) and/or Section E (Source Group Restrictions).

V. REPORTING REQUIREMENTS.

No additional reporting requirements exist except as provided in other sections of this permit including Section B (Title V General Requirements) and/or Section E (Source Group Restrictions).

VI. WORK PRACTICE REQUIREMENTS.

No additional work practice requirements exist except as provided in other sections of this permit including Section B (Title V General Requirements) and/or Section E (Source Group Restrictions).

VII. ADDITIONAL REQUIREMENTS.

No additional requirements exist except as provided in other sections of this permit including Section B (Title V General Requirements) and/or Section E (Source Group Restrictions).

***** Permit Shield in Effect. *****

**SECTION D. Source Level Requirements**

Source ID: 136

Source Name: A-2 LEAD OXIDE STORAGE SILOS (7) (BIN VENTS)

Source Capacity/Throughput: 9.500 Tons/HR LEAD OXIDE

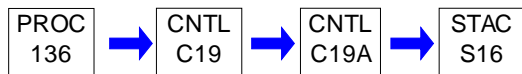
Conditions for this source occur in the following groups: SG 02 A-2 BATTERY ASSEMBLY
SG13 BIN VENT CAM**I. RESTRICTIONS.**

No additional requirements exist except as provided in other sections of this permit including Section B (Title V General Requirements) and/or Section E (Source Group Restrictions).

II. TESTING REQUIREMENTS.

No additional testing requirements exist except as provided in other sections of this permit including Section B (Title V General Requirements) and/or Section E (Source Group Restrictions).

III. MONITORING REQUIREMENTS.

No additional monitoring requirements exist except as provided in other sections of this permit including Section B (Title V General Requirements) and/or Section E (Source Group Restrictions).

IV. RECORDKEEPING REQUIREMENTS.

No additional record keeping requirements exist except as provided in other sections of this permit including Section B (Title V General Requirements) and/or Section E (Source Group Restrictions).

V. REPORTING REQUIREMENTS.

No additional reporting requirements exist except as provided in other sections of this permit including Section B (Title V General Requirements) and/or Section E (Source Group Restrictions).

VI. WORK PRACTICE REQUIREMENTS.

No additional work practice requirements exist except as provided in other sections of this permit including Section B (Title V General Requirements) and/or Section E (Source Group Restrictions).

VII. ADDITIONAL REQUIREMENTS.

No additional requirements exist except as provided in other sections of this permit including Section B (Title V General Requirements) and/or Section E (Source Group Restrictions).

***** Permit Shield in Effect. *****

**SECTION D. Source Level Requirements**

Source ID: 138

Source Name: A-2 BATT ASMBLY (FARR CC 3)

Source Capacity/Throughput: 1,100.000 Each/HR STORAGE BATTERIES

Conditions for this source occur in the following groups: SG 02 A-2 BATTERY ASSEMBLY
SG12 BAGHOUSE CAM

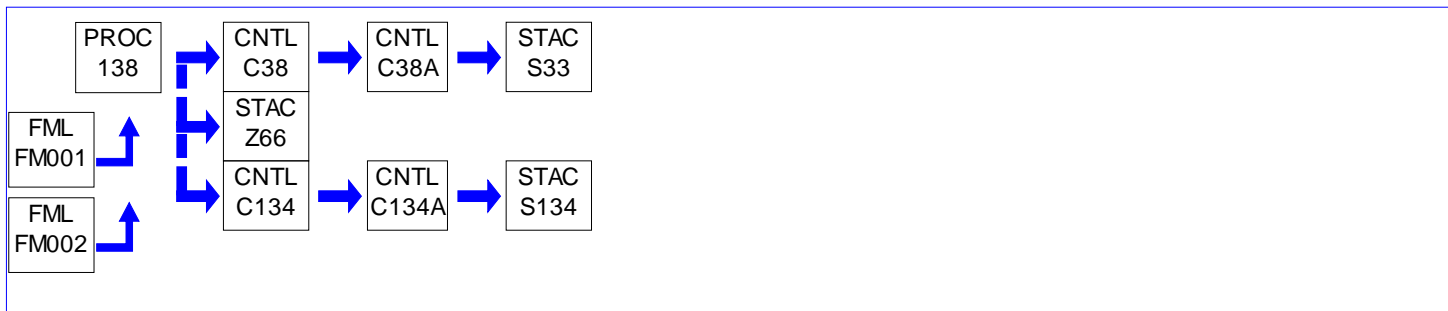
**I. RESTRICTIONS.**

No additional requirements exist except as provided in other sections of this permit including Section B (Title V General Requirements) and/or Section E (Source Group Restrictions).

II. TESTING REQUIREMENTS.

No additional testing requirements exist except as provided in other sections of this permit including Section B (Title V General Requirements) and/or Section E (Source Group Restrictions).

III. MONITORING REQUIREMENTS.

No additional monitoring requirements exist except as provided in other sections of this permit including Section B (Title V General Requirements) and/or Section E (Source Group Restrictions).

IV. RECORDKEEPING REQUIREMENTS.

No additional record keeping requirements exist except as provided in other sections of this permit including Section B (Title V General Requirements) and/or Section E (Source Group Restrictions).

V. REPORTING REQUIREMENTS.

No additional reporting requirements exist except as provided in other sections of this permit including Section B (Title V General Requirements) and/or Section E (Source Group Restrictions).

VI. WORK PRACTICE REQUIREMENTS.

No additional work practice requirements exist except as provided in other sections of this permit including Section B (Title V General Requirements) and/or Section E (Source Group Restrictions).

VII. ADDITIONAL REQUIREMENTS.

No additional requirements exist except as provided in other sections of this permit including Section B (Title V General Requirements) and/or Section E (Source Group Restrictions).

***** Permit Shield in Effect. *****

**SECTION D. Source Level Requirements**

Source ID: 139

Source Name: A-2 BATTERY FORMATION (8 MIST ELIMN)

Source Capacity/Throughput: 1,100.000 Each/HR STORAGE BATTERIES

Conditions for this source occur in the following groups: SG 02 A-2 BATTERY ASSEMBLY
SG17 MIST ELIMINATOR CAM

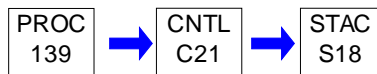
**I. RESTRICTIONS.**

No additional requirements exist except as provided in other sections of this permit including Section B (Title V General Requirements) and/or Section E (Source Group Restrictions).

II. TESTING REQUIREMENTS.

No additional testing requirements exist except as provided in other sections of this permit including Section B (Title V General Requirements) and/or Section E (Source Group Restrictions).

III. MONITORING REQUIREMENTS.

No additional monitoring requirements exist except as provided in other sections of this permit including Section B (Title V General Requirements) and/or Section E (Source Group Restrictions).

IV. RECORDKEEPING REQUIREMENTS.

No additional record keeping requirements exist except as provided in other sections of this permit including Section B (Title V General Requirements) and/or Section E (Source Group Restrictions).

V. REPORTING REQUIREMENTS.

No additional reporting requirements exist except as provided in other sections of this permit including Section B (Title V General Requirements) and/or Section E (Source Group Restrictions).

VI. WORK PRACTICE REQUIREMENTS.

No additional work practice requirements exist except as provided in other sections of this permit including Section B (Title V General Requirements) and/or Section E (Source Group Restrictions).

VII. ADDITIONAL REQUIREMENTS.

No additional requirements exist except as provided in other sections of this permit including Section B (Title V General Requirements) and/or Section E (Source Group Restrictions).

***** Permit Shield in Effect. *****

**SECTION D. Source Level Requirements**

Source ID: 140

Source Name: A-2 BATT ASMBLY D (FARR CC 4)

Source Capacity/Throughput: 1,100.000 Each/HR STORAGE BATTERIES

Conditions for this source occur in the following groups: SG 02 A-2 BATTERY ASSEMBLY
SG12 BAGHOUSE CAM

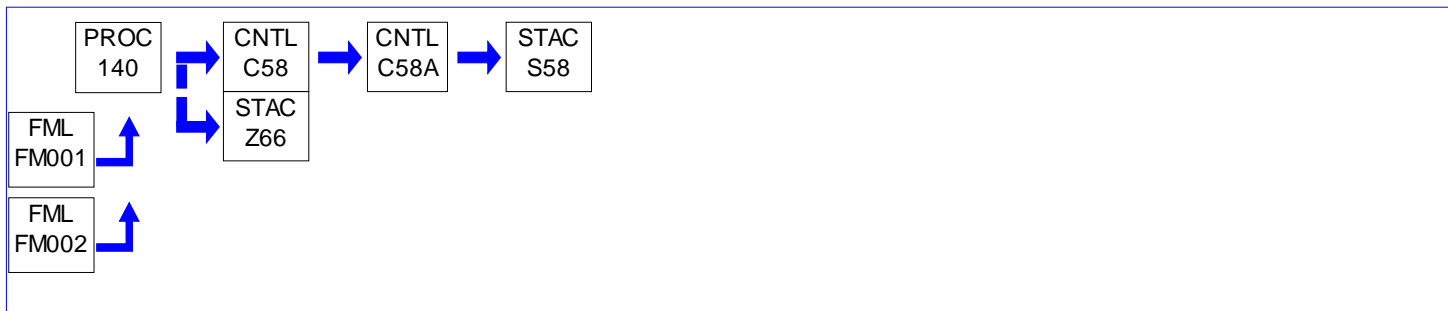
**I. RESTRICTIONS.**

No additional requirements exist except as provided in other sections of this permit including Section B (Title V General Requirements) and/or Section E (Source Group Restrictions).

II. TESTING REQUIREMENTS.

No additional testing requirements exist except as provided in other sections of this permit including Section B (Title V General Requirements) and/or Section E (Source Group Restrictions).

III. MONITORING REQUIREMENTS.

No additional monitoring requirements exist except as provided in other sections of this permit including Section B (Title V General Requirements) and/or Section E (Source Group Restrictions).

IV. RECORDKEEPING REQUIREMENTS.

No additional record keeping requirements exist except as provided in other sections of this permit including Section B (Title V General Requirements) and/or Section E (Source Group Restrictions).

V. REPORTING REQUIREMENTS.

No additional reporting requirements exist except as provided in other sections of this permit including Section B (Title V General Requirements) and/or Section E (Source Group Restrictions).

VI. WORK PRACTICE REQUIREMENTS.

No additional work practice requirements exist except as provided in other sections of this permit including Section B (Title V General Requirements) and/or Section E (Source Group Restrictions).

VII. ADDITIONAL REQUIREMENTS.

No additional requirements exist except as provided in other sections of this permit including Section B (Title V General Requirements) and/or Section E (Source Group Restrictions).

***** Permit Shield in Effect. *****

**SECTION D. Source Level Requirements**

Source ID: 141

Source Name: IND HEATSEAL BOOTH (5)

Source Capacity/Throughput:

Conditions for this source occur in the following groups: SG 04 IND BATTERY ASSEMBLY
SG14 ABSOLENT CAM

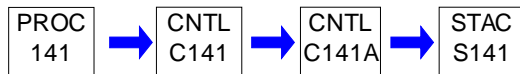
**I. RESTRICTIONS.****Emission Restriction(s).****# 001 [25 Pa. Code §127.441]****Operating permit terms and conditions.**

No person shall permit the emission into the outdoor atmosphere of particulate matter from a process in excess of 0.02 grain per dry standard cubic foot of effluent gas.

II. TESTING REQUIREMENTS.

No additional testing requirements exist except as provided in other sections of this permit including Section B (Title V General Requirements) and/or Section E (Source Group Restrictions).

III. MONITORING REQUIREMENTS.**# 002 [25 Pa. Code §127.441]****Operating permit terms and conditions.**

The permittee shall maintain instrumentation (differential manometer or equivalent, as approved by the Department) to measure and display the pressure differential across each fabric collector.

IV. RECORDKEEPING REQUIREMENTS.**# 003 [25 Pa. Code §127.441]****Operating permit terms and conditions.**

The permittee shall maintain records of all maintenance performed on each fabric collector. The permittee shall retain these records for a minimum of five (5) years and shall make them available to the department upon its request.

004 [25 Pa. Code §127.441]**Operating permit terms and conditions.**

The permittee shall monitor and record the pressure differential across each fabric collector. The pressure differential shall be recorded a minimum of once per week while a source and its fabric collector are operating. The permittee shall retain these records for a minimum of five (5) years and shall make them available to the Department upon its request.

V. REPORTING REQUIREMENTS.

No additional reporting requirements exist except as provided in other sections of this permit including Section B (Title V General Requirements) and/or Section E (Source Group Restrictions).

VI. WORK PRACTICE REQUIREMENTS.**# 005 [25 Pa. Code §127.441]****Operating permit terms and conditions.**

The permittee shall operate a collector at all times that its source is operating.

006 [25 Pa. Code §127.441]**Operating permit terms and conditions.**

The permittee shall operate each collector with its source in accordance with manufacturer's specifications.



SECTION D. Source Level Requirements

VII. ADDITIONAL REQUIREMENTS.

No additional requirements exist except as provided in other sections of this permit including Section B (Title V General Requirements) and/or Section E (Source Group Restrictions).

***** Permit Shield in Effect. *****

**SECTION D. Source Level Requirements**

Source ID: 143

Source Name: IND GRIDCASTING (SCIEN #3)

Source Capacity/Throughput: 120.000 Each/HR BATTERY CELLS

Conditions for this source occur in the following groups: SG 04 IND BATTERY ASSEMBLY
SG12 BAGHOUSE CAM

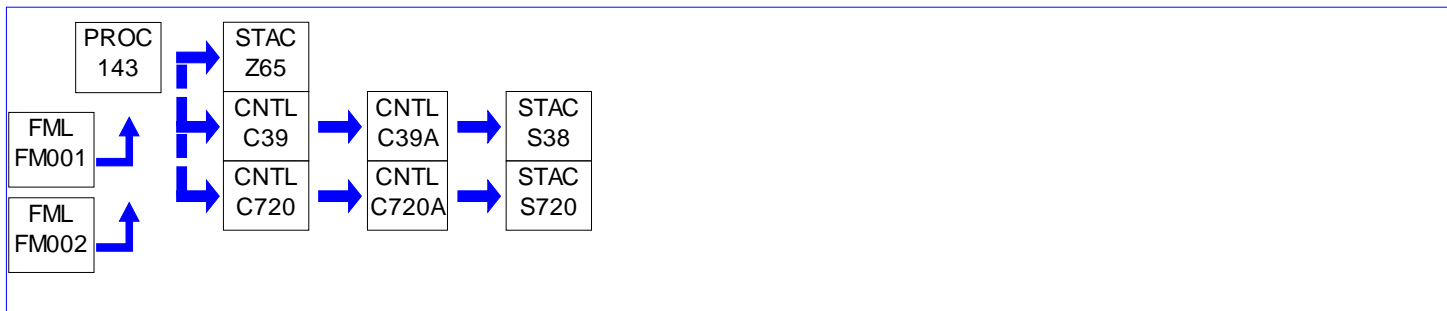
**I. RESTRICTIONS.**

No additional requirements exist except as provided in other sections of this permit including Section B (Title V General Requirements) and/or Section E (Source Group Restrictions).

II. TESTING REQUIREMENTS.

No additional testing requirements exist except as provided in other sections of this permit including Section B (Title V General Requirements) and/or Section E (Source Group Restrictions).

III. MONITORING REQUIREMENTS.

No additional monitoring requirements exist except as provided in other sections of this permit including Section B (Title V General Requirements) and/or Section E (Source Group Restrictions).

IV. RECORDKEEPING REQUIREMENTS.

No additional record keeping requirements exist except as provided in other sections of this permit including Section B (Title V General Requirements) and/or Section E (Source Group Restrictions).

V. REPORTING REQUIREMENTS.

No additional reporting requirements exist except as provided in other sections of this permit including Section B (Title V General Requirements) and/or Section E (Source Group Restrictions).

VI. WORK PRACTICE REQUIREMENTS.

No additional work practice requirements exist except as provided in other sections of this permit including Section B (Title V General Requirements) and/or Section E (Source Group Restrictions).

VII. ADDITIONAL REQUIREMENTS.

No additional requirements exist except as provided in other sections of this permit including Section B (Title V General Requirements) and/or Section E (Source Group Restrictions).

***** Permit Shield in Effect. *****

**SECTION D. Source Level Requirements**

Source ID: 144A

Source Name: IND LEAD OXIDE STORAGE SILOS (6) (BIN VENTS)

Source Capacity/Throughput:

Conditions for this source occur in the following groups: SG 04 IND BATTERY ASSEMBLY
SG13 BIN VENT CAM

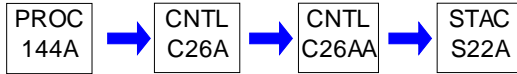
**I. RESTRICTIONS.**

No additional requirements exist except as provided in other sections of this permit including Section B (Title V General Requirements) and/or Section E (Source Group Restrictions).

II. TESTING REQUIREMENTS.

No additional testing requirements exist except as provided in other sections of this permit including Section B (Title V General Requirements) and/or Section E (Source Group Restrictions).

III. MONITORING REQUIREMENTS.

No additional monitoring requirements exist except as provided in other sections of this permit including Section B (Title V General Requirements) and/or Section E (Source Group Restrictions).

IV. RECORDKEEPING REQUIREMENTS.

No additional record keeping requirements exist except as provided in other sections of this permit including Section B (Title V General Requirements) and/or Section E (Source Group Restrictions).

V. REPORTING REQUIREMENTS.

No additional reporting requirements exist except as provided in other sections of this permit including Section B (Title V General Requirements) and/or Section E (Source Group Restrictions).

VI. WORK PRACTICE REQUIREMENTS.

No additional work practice requirements exist except as provided in other sections of this permit including Section B (Title V General Requirements) and/or Section E (Source Group Restrictions).

VII. ADDITIONAL REQUIREMENTS.

No additional requirements exist except as provided in other sections of this permit including Section B (Title V General Requirements) and/or Section E (Source Group Restrictions).

***** Permit Shield in Effect. *****

**SECTION D. Source Level Requirements**

Source ID: 146

Source Name: IND MIX (SCIEN #2) & PASTE (CARB #1)

Source Capacity/Throughput: 120.000 Each/HR BATTERY CELLS

Conditions for this source occur in the following groups: SG 04 IND BATTERY ASSEMBLY
SG12 BAGHOUSE CAM

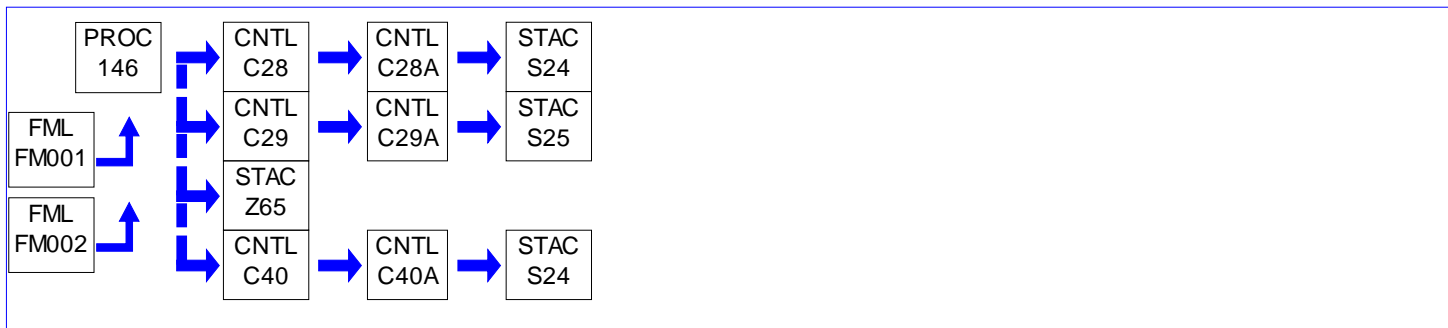
**I. RESTRICTIONS.**

No additional requirements exist except as provided in other sections of this permit including Section B (Title V General Requirements) and/or Section E (Source Group Restrictions).

II. TESTING REQUIREMENTS.

No additional testing requirements exist except as provided in other sections of this permit including Section B (Title V General Requirements) and/or Section E (Source Group Restrictions).

III. MONITORING REQUIREMENTS.

No additional monitoring requirements exist except as provided in other sections of this permit including Section B (Title V General Requirements) and/or Section E (Source Group Restrictions).

IV. RECORDKEEPING REQUIREMENTS.

No additional record keeping requirements exist except as provided in other sections of this permit including Section B (Title V General Requirements) and/or Section E (Source Group Restrictions).

V. REPORTING REQUIREMENTS.

No additional reporting requirements exist except as provided in other sections of this permit including Section B (Title V General Requirements) and/or Section E (Source Group Restrictions).

VI. WORK PRACTICE REQUIREMENTS.

No additional work practice requirements exist except as provided in other sections of this permit including Section B (Title V General Requirements) and/or Section E (Source Group Restrictions).

VII. ADDITIONAL REQUIREMENTS.

No additional requirements exist except as provided in other sections of this permit including Section B (Title V General Requirements) and/or Section E (Source Group Restrictions).

*** Permit Shield in Effect. ***

**SECTION D. Source Level Requirements**

Source ID: 147

Source Name: IND BATT ASSY/DRY CHARGE/FORM SUPP (SCIEN #4)

Source Capacity/Throughput: 120.000 Each/HR BATTERY CELLS

Conditions for this source occur in the following groups: SG 04 IND BATTERY ASSEMBLY
SG12 BAGHOUSE CAM

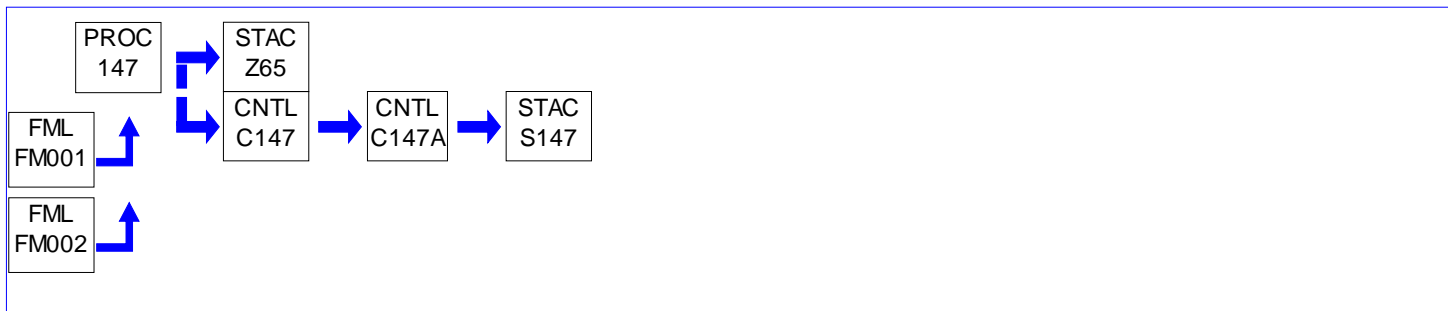
**I. RESTRICTIONS.**

No additional requirements exist except as provided in other sections of this permit including Section B (Title V General Requirements) and/or Section E (Source Group Restrictions).

II. TESTING REQUIREMENTS.

No additional testing requirements exist except as provided in other sections of this permit including Section B (Title V General Requirements) and/or Section E (Source Group Restrictions).

III. MONITORING REQUIREMENTS.

No additional monitoring requirements exist except as provided in other sections of this permit including Section B (Title V General Requirements) and/or Section E (Source Group Restrictions).

IV. RECORDKEEPING REQUIREMENTS.

No additional record keeping requirements exist except as provided in other sections of this permit including Section B (Title V General Requirements) and/or Section E (Source Group Restrictions).

V. REPORTING REQUIREMENTS.

No additional reporting requirements exist except as provided in other sections of this permit including Section B (Title V General Requirements) and/or Section E (Source Group Restrictions).

VI. WORK PRACTICE REQUIREMENTS.

No additional work practice requirements exist except as provided in other sections of this permit including Section B (Title V General Requirements) and/or Section E (Source Group Restrictions).

VII. ADDITIONAL REQUIREMENTS.

No additional requirements exist except as provided in other sections of this permit including Section B (Title V General Requirements) and/or Section E (Source Group Restrictions).

***** Permit Shield in Effect. *****

**SECTION D. Source Level Requirements**

Source ID: 148

Source Name: IND BATT ASSEMBLY (SCIEN #5)

Source Capacity/Throughput: 120.000 Each/HR BATTERY CELLS

Conditions for this source occur in the following groups: SG 04 IND BATTERY ASSEMBLY
SG12 BAGHOUSE CAM

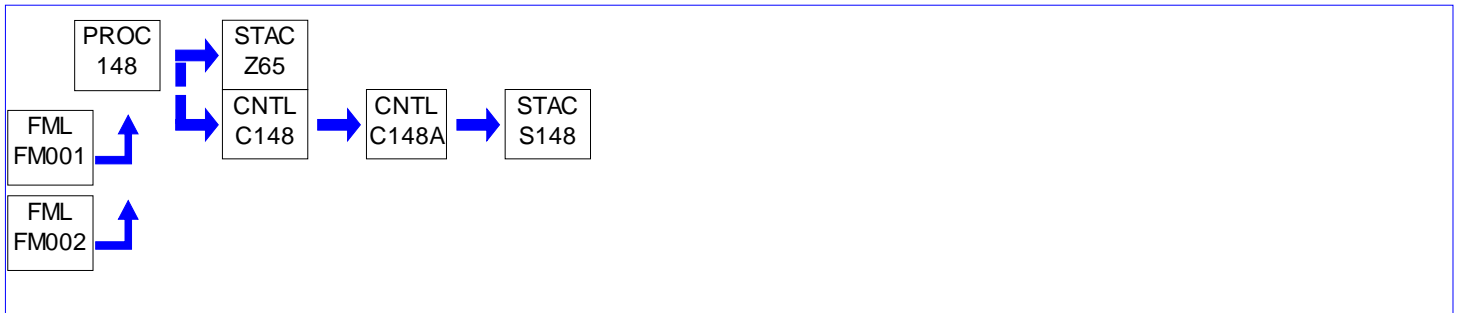
**I. RESTRICTIONS.**

No additional requirements exist except as provided in other sections of this permit including Section B (Title V General Requirements) and/or Section E (Source Group Restrictions).

II. TESTING REQUIREMENTS.

No additional testing requirements exist except as provided in other sections of this permit including Section B (Title V General Requirements) and/or Section E (Source Group Restrictions).

III. MONITORING REQUIREMENTS.

No additional monitoring requirements exist except as provided in other sections of this permit including Section B (Title V General Requirements) and/or Section E (Source Group Restrictions).

IV. RECORDKEEPING REQUIREMENTS.

No additional record keeping requirements exist except as provided in other sections of this permit including Section B (Title V General Requirements) and/or Section E (Source Group Restrictions).

V. REPORTING REQUIREMENTS.

No additional reporting requirements exist except as provided in other sections of this permit including Section B (Title V General Requirements) and/or Section E (Source Group Restrictions).

VI. WORK PRACTICE REQUIREMENTS.

No additional work practice requirements exist except as provided in other sections of this permit including Section B (Title V General Requirements) and/or Section E (Source Group Restrictions).

VII. ADDITIONAL REQUIREMENTS.

No additional requirements exist except as provided in other sections of this permit including Section B (Title V General Requirements) and/or Section E (Source Group Restrictions).

***** Permit Shield in Effect. *****

**SECTION D. Source Level Requirements**

Source ID: 149

Source Name: IND FORMING ROOM & WET CHARGE (4 MIST ELIM)

Source Capacity/Throughput: 120.000 Each/HR BATTERY CELLS

Conditions for this source occur in the following groups: SG 04 IND BATTERY ASSEMBLY
 SG12 BAGHOUSE CAM
 SG17 MIST ELIMINATOR CAM

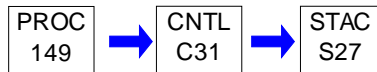
**I. RESTRICTIONS.**

No additional requirements exist except as provided in other sections of this permit including Section B (Title V General Requirements) and/or Section E (Source Group Restrictions).

II. TESTING REQUIREMENTS.

No additional testing requirements exist except as provided in other sections of this permit including Section B (Title V General Requirements) and/or Section E (Source Group Restrictions).

III. MONITORING REQUIREMENTS.

No additional monitoring requirements exist except as provided in other sections of this permit including Section B (Title V General Requirements) and/or Section E (Source Group Restrictions).

IV. RECORDKEEPING REQUIREMENTS.

No additional record keeping requirements exist except as provided in other sections of this permit including Section B (Title V General Requirements) and/or Section E (Source Group Restrictions).

V. REPORTING REQUIREMENTS.

No additional reporting requirements exist except as provided in other sections of this permit including Section B (Title V General Requirements) and/or Section E (Source Group Restrictions).

VI. WORK PRACTICE REQUIREMENTS.

No additional work practice requirements exist except as provided in other sections of this permit including Section B (Title V General Requirements) and/or Section E (Source Group Restrictions).

VII. ADDITIONAL REQUIREMENTS.

No additional requirements exist except as provided in other sections of this permit including Section B (Title V General Requirements) and/or Section E (Source Group Restrictions).

***** Permit Shield in Effect. *****



SECTION D. Source Level Requirements

Source ID: 150 Source Name: IND BATTERY BOOST (4 MIST ELIM)
Source Capacity/Throughput: 120.000 Each/HR BATTERY CELLS

Conditions for this source occur in the following groups: SG 04 IND BATTERY ASSEMBLY
SG12 BAGHOUSE CAM
SG17 MIST ELIMINATOR CAM



I. RESTRICTIONS.

No additional requirements exist except as provided in other sections of this permit including Section B (Title V General Requirements) and/or Section E (Source Group Restrictions).

II. TESTING REQUIREMENTS.

No additional testing requirements exist except as provided in other sections of this permit including Section B (Title V General Requirements) and/or Section E (Source Group Restrictions).

III. MONITORING REQUIREMENTS.

No additional monitoring requirements exist except as provided in other sections of this permit including Section B (Title V General Requirements) and/or Section E (Source Group Restrictions).

IV. RECORDKEEPING REQUIREMENTS.

No additional record keeping requirements exist except as provided in other sections of this permit including Section B (Title V General Requirements) and/or Section E (Source Group Restrictions).

V. REPORTING REQUIREMENTS.

No additional reporting requirements exist except as provided in other sections of this permit including Section B (Title V General Requirements) and/or Section E (Source Group Restrictions).

VI. WORK PRACTICE REQUIREMENTS.

No additional work practice requirements exist except as provided in other sections of this permit including Section B (Title V General Requirements) and/or Section E (Source Group Restrictions).

VII. ADDITIONAL REQUIREMENTS.

No additional requirements exist except as provided in other sections of this permit including Section B (Title V General Requirements) and/or Section E (Source Group Restrictions).

***** Permit Shield in Effect. *****

**SECTION D. Source Level Requirements**

Source ID: 151

Source Name: A-3 PASTE MIXING (SCIENTIFIC FC #6)

Source Capacity/Throughput: 500.000 Each/HR STORAGE BATTERIES

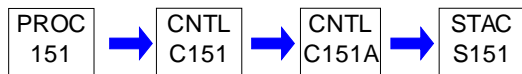
Conditions for this source occur in the following groups: SG 03 A-3 BATTERY ASSEMBLY
SG12 BAGHOUSE CAM**I. RESTRICTIONS.**

No additional requirements exist except as provided in other sections of this permit including Section B (Title V General Requirements) and/or Section E (Source Group Restrictions).

II. TESTING REQUIREMENTS.

No additional testing requirements exist except as provided in other sections of this permit including Section B (Title V General Requirements) and/or Section E (Source Group Restrictions).

III. MONITORING REQUIREMENTS.

No additional monitoring requirements exist except as provided in other sections of this permit including Section B (Title V General Requirements) and/or Section E (Source Group Restrictions).

IV. RECORDKEEPING REQUIREMENTS.

No additional record keeping requirements exist except as provided in other sections of this permit including Section B (Title V General Requirements) and/or Section E (Source Group Restrictions).

V. REPORTING REQUIREMENTS.

No additional reporting requirements exist except as provided in other sections of this permit including Section B (Title V General Requirements) and/or Section E (Source Group Restrictions).

VI. WORK PRACTICE REQUIREMENTS.

No additional work practice requirements exist except as provided in other sections of this permit including Section B (Title V General Requirements) and/or Section E (Source Group Restrictions).

VII. ADDITIONAL REQUIREMENTS.

No additional requirements exist except as provided in other sections of this permit including Section B (Title V General Requirements) and/or Section E (Source Group Restrictions).

***** Permit Shield in Effect. *****

**SECTION D. Source Level Requirements**

Source ID: 152

Source Name: A-3 BATTERY ASSEMBLY (SCIENTIFIC CC #1)

Source Capacity/Throughput: 500.000 Each/HR STORAGE BATTERIES

Conditions for this source occur in the following groups: SG 03 A-3 BATTERY ASSEMBLY
SG12 BAGHOUSE CAM

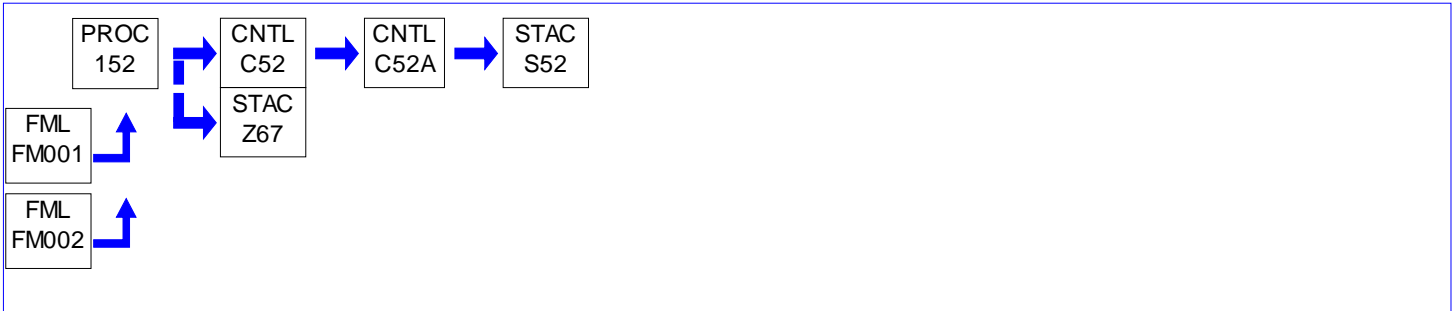
**I. RESTRICTIONS.**

No additional requirements exist except as provided in other sections of this permit including Section B (Title V General Requirements) and/or Section E (Source Group Restrictions).

II. TESTING REQUIREMENTS.

No additional testing requirements exist except as provided in other sections of this permit including Section B (Title V General Requirements) and/or Section E (Source Group Restrictions).

III. MONITORING REQUIREMENTS.

No additional monitoring requirements exist except as provided in other sections of this permit including Section B (Title V General Requirements) and/or Section E (Source Group Restrictions).

IV. RECORDKEEPING REQUIREMENTS.

No additional record keeping requirements exist except as provided in other sections of this permit including Section B (Title V General Requirements) and/or Section E (Source Group Restrictions).

V. REPORTING REQUIREMENTS.

No additional reporting requirements exist except as provided in other sections of this permit including Section B (Title V General Requirements) and/or Section E (Source Group Restrictions).

VI. WORK PRACTICE REQUIREMENTS.

No additional work practice requirements exist except as provided in other sections of this permit including Section B (Title V General Requirements) and/or Section E (Source Group Restrictions).

VII. ADDITIONAL REQUIREMENTS.

No additional requirements exist except as provided in other sections of this permit including Section B (Title V General Requirements) and/or Section E (Source Group Restrictions).

***** Permit Shield in Effect. *****

**SECTION D. Source Level Requirements**

Source ID: 153

Source Name: A-3 COS & ENVELOPE A (SCIENTIFIC FC #2)

Source Capacity/Throughput: 500.000 Each/HR STORAGE BATTERIES

Conditions for this source occur in the following groups: SG 03 A-3 BATTERY ASSEMBLY
SG12 BAGHOUSE CAM

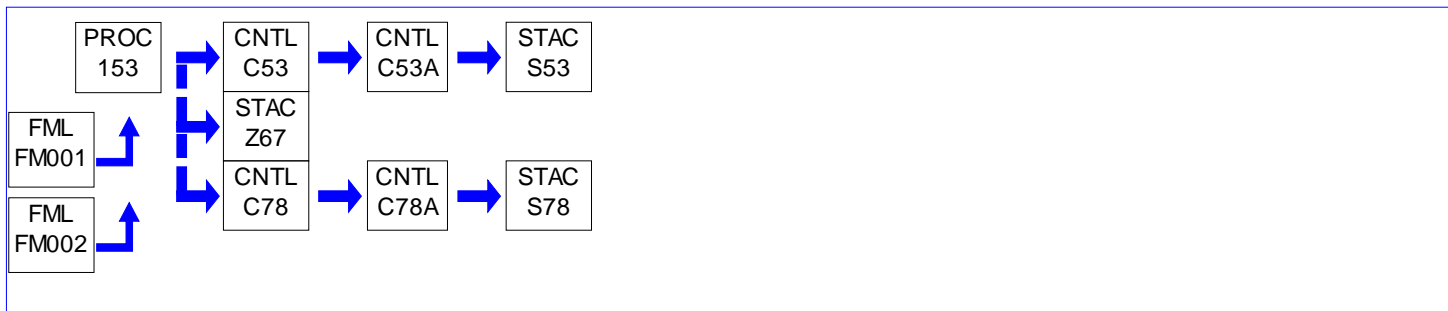
**I. RESTRICTIONS.**

No additional requirements exist except as provided in other sections of this permit including Section B (Title V General Requirements) and/or Section E (Source Group Restrictions).

II. TESTING REQUIREMENTS.

No additional testing requirements exist except as provided in other sections of this permit including Section B (Title V General Requirements) and/or Section E (Source Group Restrictions).

III. MONITORING REQUIREMENTS.

No additional monitoring requirements exist except as provided in other sections of this permit including Section B (Title V General Requirements) and/or Section E (Source Group Restrictions).

IV. RECORDKEEPING REQUIREMENTS.

No additional record keeping requirements exist except as provided in other sections of this permit including Section B (Title V General Requirements) and/or Section E (Source Group Restrictions).

V. REPORTING REQUIREMENTS.

No additional reporting requirements exist except as provided in other sections of this permit including Section B (Title V General Requirements) and/or Section E (Source Group Restrictions).

VI. WORK PRACTICE REQUIREMENTS.

No additional work practice requirements exist except as provided in other sections of this permit including Section B (Title V General Requirements) and/or Section E (Source Group Restrictions).

VII. ADDITIONAL REQUIREMENTS.

No additional requirements exist except as provided in other sections of this permit including Section B (Title V General Requirements) and/or Section E (Source Group Restrictions).

***** Permit Shield in Effect. *****

**SECTION D. Source Level Requirements**

Source ID: 154

Source Name: A-3 LEAD OXIDE STORAGE SILOS (3) (BIN VENTS)

Source Capacity/Throughput: 27.300 Tons/HR LEAD OXIDE

Conditions for this source occur in the following groups: SG 03 A-3 BATTERY ASSEMBLY

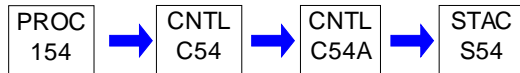
**I. RESTRICTIONS.**

No additional requirements exist except as provided in other sections of this permit including Section B (Title V General Requirements) and/or Section E (Source Group Restrictions).

II. TESTING REQUIREMENTS.

No additional testing requirements exist except as provided in other sections of this permit including Section B (Title V General Requirements) and/or Section E (Source Group Restrictions).

III. MONITORING REQUIREMENTS.

No additional monitoring requirements exist except as provided in other sections of this permit including Section B (Title V General Requirements) and/or Section E (Source Group Restrictions).

IV. RECORDKEEPING REQUIREMENTS.

No additional record keeping requirements exist except as provided in other sections of this permit including Section B (Title V General Requirements) and/or Section E (Source Group Restrictions).

V. REPORTING REQUIREMENTS.

No additional reporting requirements exist except as provided in other sections of this permit including Section B (Title V General Requirements) and/or Section E (Source Group Restrictions).

VI. WORK PRACTICE REQUIREMENTS.

No additional work practice requirements exist except as provided in other sections of this permit including Section B (Title V General Requirements) and/or Section E (Source Group Restrictions).

VII. ADDITIONAL REQUIREMENTS.

No additional requirements exist except as provided in other sections of this permit including Section B (Title V General Requirements) and/or Section E (Source Group Restrictions).

***** Permit Shield in Effect. *****

**SECTION D. Source Level Requirements**

Source ID: 156

Source Name: A-3 GRIDCAST (SCIENTIFIC FC #6)

Source Capacity/Throughput: 500.000 Each/HR STORAGE BATTERIES

Conditions for this source occur in the following groups: SG 03 A-3 BATTERY ASSEMBLY
SG12 BAGHOUSE CAM

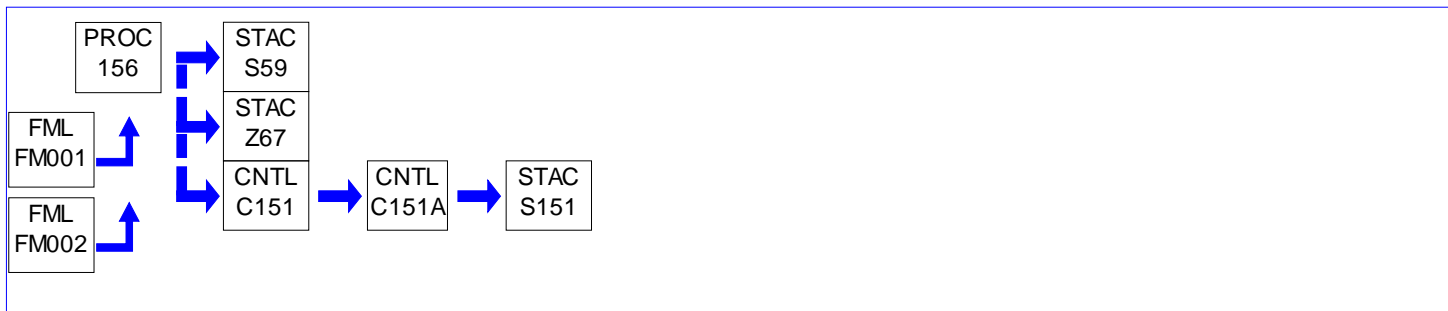
**I. RESTRICTIONS.**

No additional requirements exist except as provided in other sections of this permit including Section B (Title V General Requirements) and/or Section E (Source Group Restrictions).

II. TESTING REQUIREMENTS.

No additional testing requirements exist except as provided in other sections of this permit including Section B (Title V General Requirements) and/or Section E (Source Group Restrictions).

III. MONITORING REQUIREMENTS.

No additional monitoring requirements exist except as provided in other sections of this permit including Section B (Title V General Requirements) and/or Section E (Source Group Restrictions).

IV. RECORDKEEPING REQUIREMENTS.

No additional record keeping requirements exist except as provided in other sections of this permit including Section B (Title V General Requirements) and/or Section E (Source Group Restrictions).

V. REPORTING REQUIREMENTS.

No additional reporting requirements exist except as provided in other sections of this permit including Section B (Title V General Requirements) and/or Section E (Source Group Restrictions).

VI. WORK PRACTICE REQUIREMENTS.

No additional work practice requirements exist except as provided in other sections of this permit including Section B (Title V General Requirements) and/or Section E (Source Group Restrictions).

VII. ADDITIONAL REQUIREMENTS.

No additional requirements exist except as provided in other sections of this permit including Section B (Title V General Requirements) and/or Section E (Source Group Restrictions).

***** Permit Shield in Effect. *****

**SECTION D. Source Level Requirements**

Source ID: 156A

Source Name: A-3 CONCAST (SCIEN FC 6)

Source Capacity/Throughput: 500.000 Each/HR STORAGE BATTERIES

Conditions for this source occur in the following groups: SG 03 A-3 BATTERY ASSEMBLY
 SG10B RACT 2
 SG12 BAGHOUSE CAM
 SG20 RACT III PRESUMPTIVE

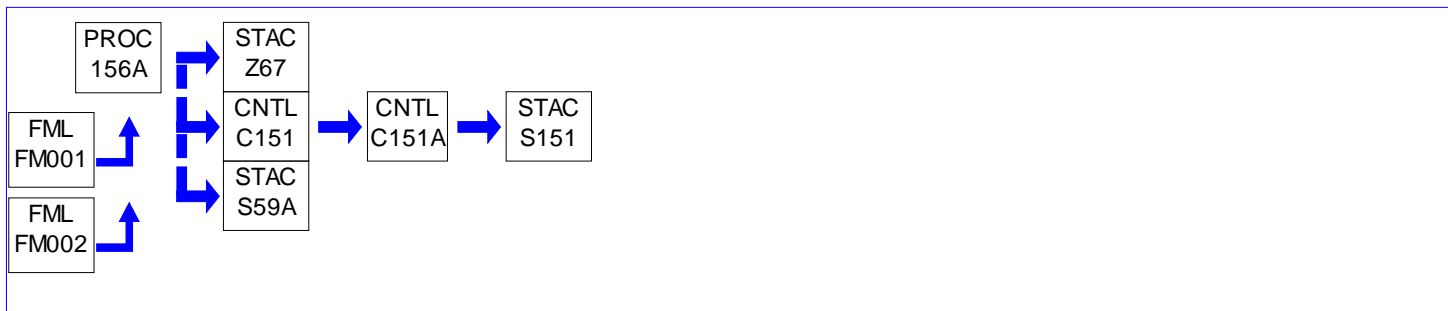
**I. RESTRICTIONS.**

No additional requirements exist except as provided in other sections of this permit including Section B (Title V General Requirements) and/or Section E (Source Group Restrictions).

II. TESTING REQUIREMENTS.

No additional testing requirements exist except as provided in other sections of this permit including Section B (Title V General Requirements) and/or Section E (Source Group Restrictions).

III. MONITORING REQUIREMENTS.

No additional monitoring requirements exist except as provided in other sections of this permit including Section B (Title V General Requirements) and/or Section E (Source Group Restrictions).

IV. RECORDKEEPING REQUIREMENTS.

No additional record keeping requirements exist except as provided in other sections of this permit including Section B (Title V General Requirements) and/or Section E (Source Group Restrictions).

V. REPORTING REQUIREMENTS.

No additional reporting requirements exist except as provided in other sections of this permit including Section B (Title V General Requirements) and/or Section E (Source Group Restrictions).

VI. WORK PRACTICE REQUIREMENTS.

No additional work practice requirements exist except as provided in other sections of this permit including Section B (Title V General Requirements) and/or Section E (Source Group Restrictions).

VII. ADDITIONAL REQUIREMENTS.

No additional requirements exist except as provided in other sections of this permit including Section B (Title V General Requirements) and/or Section E (Source Group Restrictions).



SECTION D. Source Level Requirements

***** Permit Shield in Effect. *****



SECTION D. Source Level Requirements

Source ID: 157

Source Name: A-3 COS & ENVELOPE B (SCIENTIFIC FC #3)

Source Capacity/Throughput: 500.000 Each/HR STORAGE BATTERIES

Conditions for this source occur in the following groups: SG 03 A-3 BATTERY ASSEMBLY
SG12 BAGHOUSE CAM

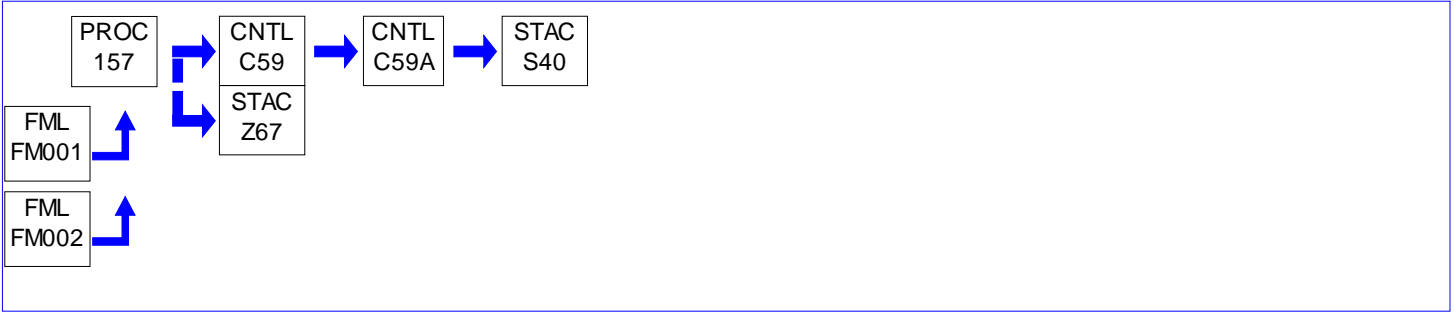

I. RESTRICTIONS.

No additional requirements exist except as provided in other sections of this permit including Section B (Title V General Requirements) and/or Section E (Source Group Restrictions).

II. TESTING REQUIREMENTS.

No additional testing requirements exist except as provided in other sections of this permit including Section B (Title V General Requirements) and/or Section E (Source Group Restrictions).

III. MONITORING REQUIREMENTS.

No additional monitoring requirements exist except as provided in other sections of this permit including Section B (Title V General Requirements) and/or Section E (Source Group Restrictions).

IV. RECORDKEEPING REQUIREMENTS.

No additional record keeping requirements exist except as provided in other sections of this permit including Section B (Title V General Requirements) and/or Section E (Source Group Restrictions).

V. REPORTING REQUIREMENTS.

No additional reporting requirements exist except as provided in other sections of this permit including Section B (Title V General Requirements) and/or Section E (Source Group Restrictions).

VI. WORK PRACTICE REQUIREMENTS.

No additional work practice requirements exist except as provided in other sections of this permit including Section B (Title V General Requirements) and/or Section E (Source Group Restrictions).

VII. ADDITIONAL REQUIREMENTS.

No additional requirements exist except as provided in other sections of this permit including Section B (Title V General Requirements) and/or Section E (Source Group Restrictions).

***** Permit Shield in Effect. *****

**SECTION D. Source Level Requirements**

Source ID: 158

Source Name: A-3 COS & ENVELOPE D (SCIENTIFIC FC #4)

Source Capacity/Throughput: 500.000 Each/HR STORAGE BATTERIES

Conditions for this source occur in the following groups: SG 03 A-3 BATTERY ASSEMBLY
SG12 BAGHOUSE CAM

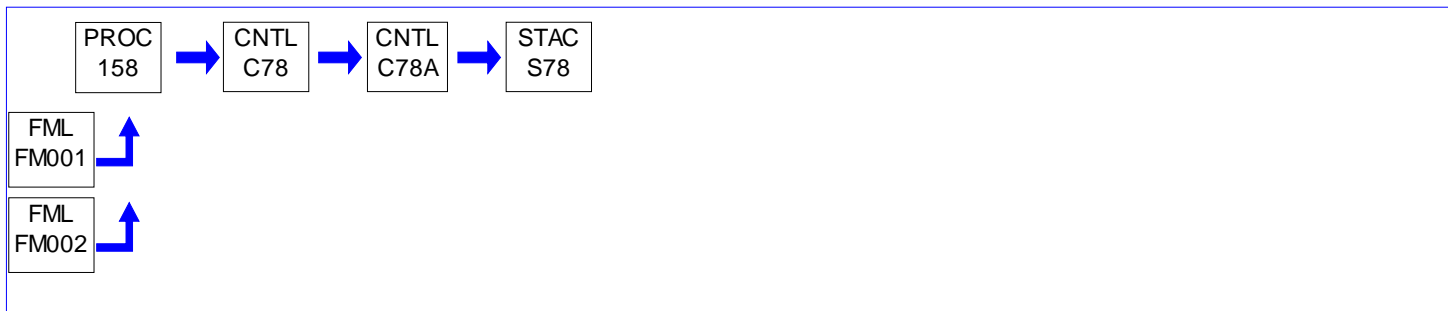
**I. RESTRICTIONS.**

No additional requirements exist except as provided in other sections of this permit including Section B (Title V General Requirements) and/or Section E (Source Group Restrictions).

II. TESTING REQUIREMENTS.

No additional testing requirements exist except as provided in other sections of this permit including Section B (Title V General Requirements) and/or Section E (Source Group Restrictions).

III. MONITORING REQUIREMENTS.

No additional monitoring requirements exist except as provided in other sections of this permit including Section B (Title V General Requirements) and/or Section E (Source Group Restrictions).

IV. RECORDKEEPING REQUIREMENTS.

No additional record keeping requirements exist except as provided in other sections of this permit including Section B (Title V General Requirements) and/or Section E (Source Group Restrictions).

V. REPORTING REQUIREMENTS.

No additional reporting requirements exist except as provided in other sections of this permit including Section B (Title V General Requirements) and/or Section E (Source Group Restrictions).

VI. WORK PRACTICE REQUIREMENTS.

No additional work practice requirements exist except as provided in other sections of this permit including Section B (Title V General Requirements) and/or Section E (Source Group Restrictions).

VII. ADDITIONAL REQUIREMENTS.

No additional requirements exist except as provided in other sections of this permit including Section B (Title V General Requirements) and/or Section E (Source Group Restrictions).

***** Permit Shield in Effect. *****



SECTION D. Source Level Requirements

Source ID: 159

Source Name: A-3 COS & STACKING C (SCIENTIFIC FC #5)

Source Capacity/Throughput: 500.000 Each/HR STORAGE BATTERIES

Conditions for this source occur in the following groups: SG 03 A-3 BATTERY ASSEMBLY
SG12 BAGHOUSE CAM

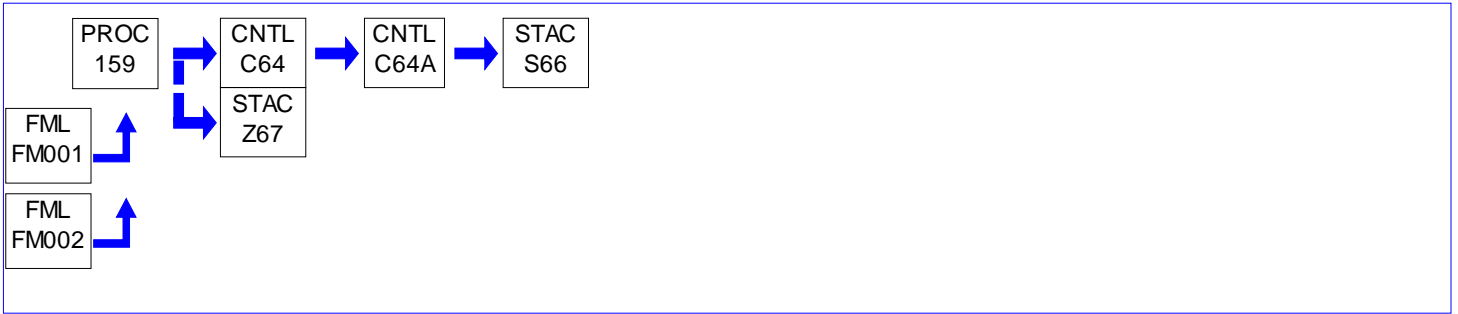

I. RESTRICTIONS.

No additional requirements exist except as provided in other sections of this permit including Section B (Title V General Requirements) and/or Section E (Source Group Restrictions).

II. TESTING REQUIREMENTS.

No additional testing requirements exist except as provided in other sections of this permit including Section B (Title V General Requirements) and/or Section E (Source Group Restrictions).

III. MONITORING REQUIREMENTS.

No additional monitoring requirements exist except as provided in other sections of this permit including Section B (Title V General Requirements) and/or Section E (Source Group Restrictions).

IV. RECORDKEEPING REQUIREMENTS.

No additional record keeping requirements exist except as provided in other sections of this permit including Section B (Title V General Requirements) and/or Section E (Source Group Restrictions).

V. REPORTING REQUIREMENTS.

No additional reporting requirements exist except as provided in other sections of this permit including Section B (Title V General Requirements) and/or Section E (Source Group Restrictions).

VI. WORK PRACTICE REQUIREMENTS.

No additional work practice requirements exist except as provided in other sections of this permit including Section B (Title V General Requirements) and/or Section E (Source Group Restrictions).

VII. ADDITIONAL REQUIREMENTS.

No additional requirements exist except as provided in other sections of this permit including Section B (Title V General Requirements) and/or Section E (Source Group Restrictions).

***** Permit Shield in Effect. *****

**SECTION D. Source Level Requirements**

Source ID: 160

Source Name: LEAD OXIDE MILL 5

Source Capacity/Throughput:	2,600.000 Lbs/HR	LEAD OXIDE
	750.000 CF/HR	Natural Gas

Conditions for this source occur in the following groups: SG 05 OXIDE PLANT

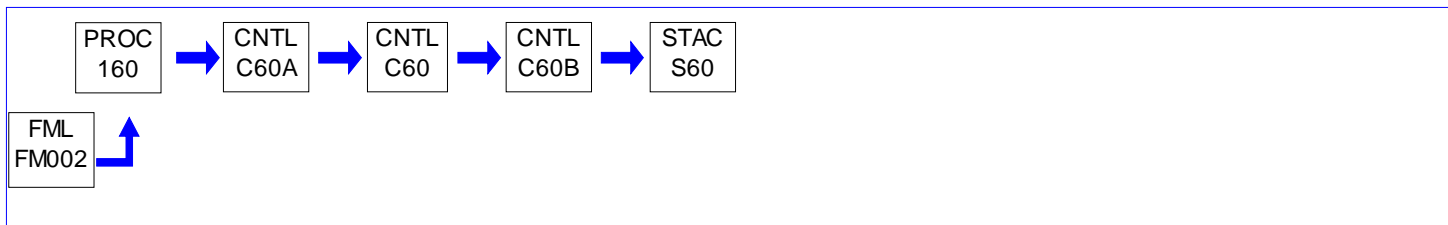
**I. RESTRICTIONS.**

No additional requirements exist except as provided in other sections of this permit including Section B (Title V General Requirements) and/or Section E (Source Group Restrictions).

II. TESTING REQUIREMENTS.

No additional testing requirements exist except as provided in other sections of this permit including Section B (Title V General Requirements) and/or Section E (Source Group Restrictions).

III. MONITORING REQUIREMENTS.

No additional monitoring requirements exist except as provided in other sections of this permit including Section B (Title V General Requirements) and/or Section E (Source Group Restrictions).

IV. RECORDKEEPING REQUIREMENTS.

No additional record keeping requirements exist except as provided in other sections of this permit including Section B (Title V General Requirements) and/or Section E (Source Group Restrictions).

V. REPORTING REQUIREMENTS.

No additional reporting requirements exist except as provided in other sections of this permit including Section B (Title V General Requirements) and/or Section E (Source Group Restrictions).

VI. WORK PRACTICE REQUIREMENTS.

No additional work practice requirements exist except as provided in other sections of this permit including Section B (Title V General Requirements) and/or Section E (Source Group Restrictions).

VII. ADDITIONAL REQUIREMENTS.

No additional requirements exist except as provided in other sections of this permit including Section B (Title V General Requirements) and/or Section E (Source Group Restrictions).

***** Permit Shield in Effect. *****

**SECTION D. Source Level Requirements**

Source ID: 161

Source Name: LEAD OXIDE MILL 6

Source Capacity/Throughput: 2,600.000 Lbs/HR

LEAD OXIDE

750.000 CF/HR

Natural Gas

Conditions for this source occur in the following groups: SG 05 OXIDE PLANT

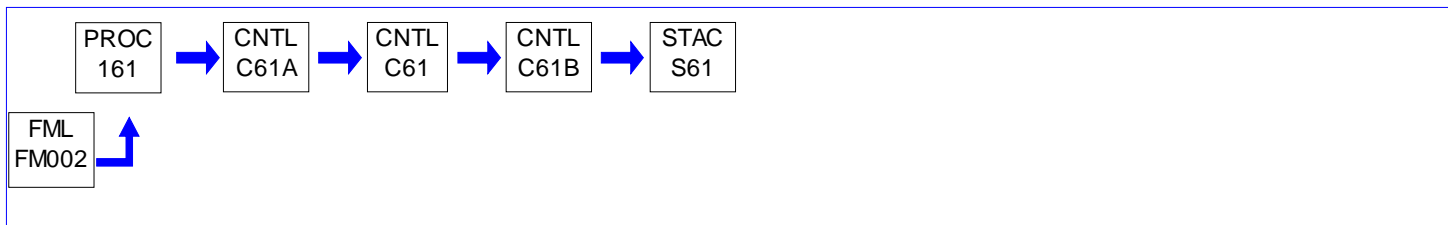
**I. RESTRICTIONS.**

No additional requirements exist except as provided in other sections of this permit including Section B (Title V General Requirements) and/or Section E (Source Group Restrictions).

II. TESTING REQUIREMENTS.

No additional testing requirements exist except as provided in other sections of this permit including Section B (Title V General Requirements) and/or Section E (Source Group Restrictions).

III. MONITORING REQUIREMENTS.

No additional monitoring requirements exist except as provided in other sections of this permit including Section B (Title V General Requirements) and/or Section E (Source Group Restrictions).

IV. RECORDKEEPING REQUIREMENTS.

No additional record keeping requirements exist except as provided in other sections of this permit including Section B (Title V General Requirements) and/or Section E (Source Group Restrictions).

V. REPORTING REQUIREMENTS.

No additional reporting requirements exist except as provided in other sections of this permit including Section B (Title V General Requirements) and/or Section E (Source Group Restrictions).

VI. WORK PRACTICE REQUIREMENTS.

No additional work practice requirements exist except as provided in other sections of this permit including Section B (Title V General Requirements) and/or Section E (Source Group Restrictions).

VII. ADDITIONAL REQUIREMENTS.

No additional requirements exist except as provided in other sections of this permit including Section B (Title V General Requirements) and/or Section E (Source Group Restrictions).

***** Permit Shield in Effect. *****

**SECTION D. Source Level Requirements**

Source ID: 162

Source Name: LEAD OXIDE MILL 7

Source Capacity/Throughput: 2,600.000 Lbs/HR
750.000 CF/HRLEAD OXIDE
Natural Gas

Conditions for this source occur in the following groups: SG 05 OXIDE PLANT

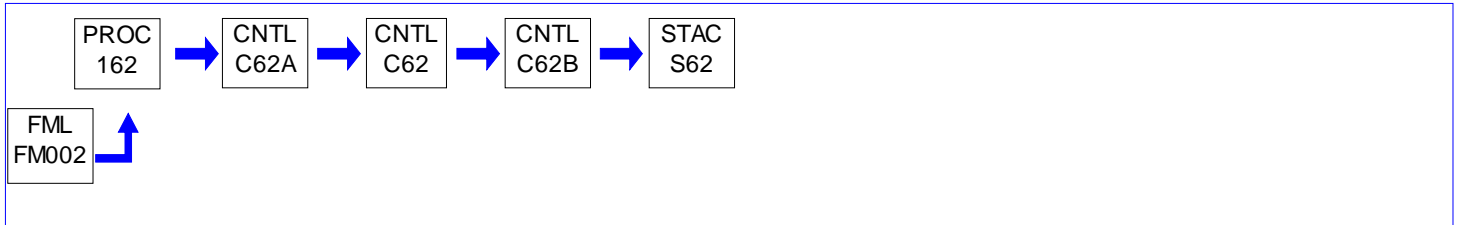
**I. RESTRICTIONS.**

No additional requirements exist except as provided in other sections of this permit including Section B (Title V General Requirements) and/or Section E (Source Group Restrictions).

II. TESTING REQUIREMENTS.

No additional testing requirements exist except as provided in other sections of this permit including Section B (Title V General Requirements) and/or Section E (Source Group Restrictions).

III. MONITORING REQUIREMENTS.

No additional monitoring requirements exist except as provided in other sections of this permit including Section B (Title V General Requirements) and/or Section E (Source Group Restrictions).

IV. RECORDKEEPING REQUIREMENTS.

No additional record keeping requirements exist except as provided in other sections of this permit including Section B (Title V General Requirements) and/or Section E (Source Group Restrictions).

V. REPORTING REQUIREMENTS.

No additional reporting requirements exist except as provided in other sections of this permit including Section B (Title V General Requirements) and/or Section E (Source Group Restrictions).

VI. WORK PRACTICE REQUIREMENTS.

No additional work practice requirements exist except as provided in other sections of this permit including Section B (Title V General Requirements) and/or Section E (Source Group Restrictions).

VII. ADDITIONAL REQUIREMENTS.

No additional requirements exist except as provided in other sections of this permit including Section B (Title V General Requirements) and/or Section E (Source Group Restrictions).

***** Permit Shield in Effect. *****

**SECTION D. Source Level Requirements**

Source ID: 163

Source Name: LEAD OXIDE MILL 8

Source Capacity/Throughput: 2,600.000 Lbs/HR
750.000 CF/HRLEAD OXIDE
Natural Gas

Conditions for this source occur in the following groups: SG 05 OXIDE PLANT

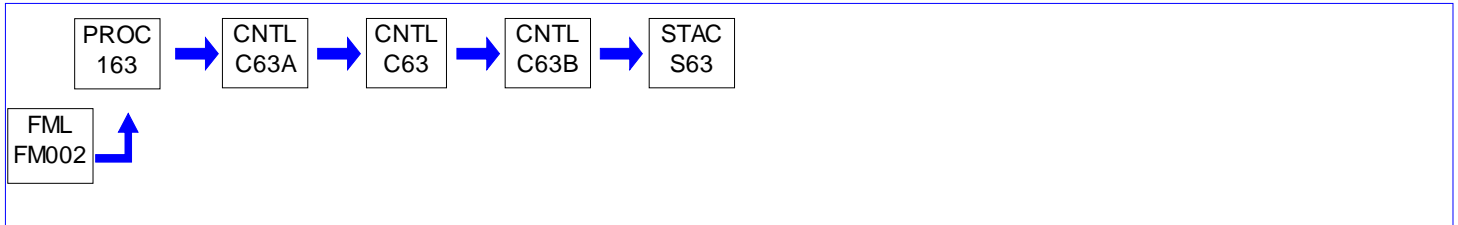
**I. RESTRICTIONS.**

No additional requirements exist except as provided in other sections of this permit including Section B (Title V General Requirements) and/or Section E (Source Group Restrictions).

II. TESTING REQUIREMENTS.

No additional testing requirements exist except as provided in other sections of this permit including Section B (Title V General Requirements) and/or Section E (Source Group Restrictions).

III. MONITORING REQUIREMENTS.

No additional monitoring requirements exist except as provided in other sections of this permit including Section B (Title V General Requirements) and/or Section E (Source Group Restrictions).

IV. RECORDKEEPING REQUIREMENTS.

No additional record keeping requirements exist except as provided in other sections of this permit including Section B (Title V General Requirements) and/or Section E (Source Group Restrictions).

V. REPORTING REQUIREMENTS.

No additional reporting requirements exist except as provided in other sections of this permit including Section B (Title V General Requirements) and/or Section E (Source Group Restrictions).

VI. WORK PRACTICE REQUIREMENTS.

No additional work practice requirements exist except as provided in other sections of this permit including Section B (Title V General Requirements) and/or Section E (Source Group Restrictions).

VII. ADDITIONAL REQUIREMENTS.

No additional requirements exist except as provided in other sections of this permit including Section B (Title V General Requirements) and/or Section E (Source Group Restrictions).

***** Permit Shield in Effect. *****

**SECTION D. Source Level Requirements**

Source ID: 169

Source Name: LEAD OXIDE MILL 9

Source Capacity/Throughput: 2,600.000 Lbs/HR
750.000 CF/HRLEAD OXIDE
Natural Gas

Conditions for this source occur in the following groups: SG 05 OXIDE PLANT

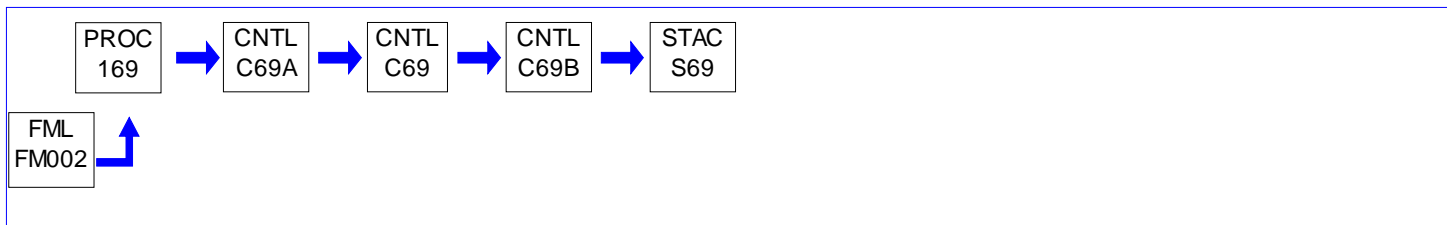
**I. RESTRICTIONS.**

No additional requirements exist except as provided in other sections of this permit including Section B (Title V General Requirements) and/or Section E (Source Group Restrictions).

II. TESTING REQUIREMENTS.

No additional testing requirements exist except as provided in other sections of this permit including Section B (Title V General Requirements) and/or Section E (Source Group Restrictions).

III. MONITORING REQUIREMENTS.

No additional monitoring requirements exist except as provided in other sections of this permit including Section B (Title V General Requirements) and/or Section E (Source Group Restrictions).

IV. RECORDKEEPING REQUIREMENTS.

No additional record keeping requirements exist except as provided in other sections of this permit including Section B (Title V General Requirements) and/or Section E (Source Group Restrictions).

V. REPORTING REQUIREMENTS.

No additional reporting requirements exist except as provided in other sections of this permit including Section B (Title V General Requirements) and/or Section E (Source Group Restrictions).

VI. WORK PRACTICE REQUIREMENTS.

No additional work practice requirements exist except as provided in other sections of this permit including Section B (Title V General Requirements) and/or Section E (Source Group Restrictions).

VII. ADDITIONAL REQUIREMENTS.

No additional requirements exist except as provided in other sections of this permit including Section B (Title V General Requirements) and/or Section E (Source Group Restrictions).

***** Permit Shield in Effect. *****

**SECTION D. Source Level Requirements**

Source ID: 170

Source Name: LEAD OXIDE MILL 10

Source Capacity/Throughput:	2,600.000 Lbs/HR	LEAD OXIDE
	750.000 CF/HR	Natural Gas

Conditions for this source occur in the following groups: SG 05 OXIDE PLANT

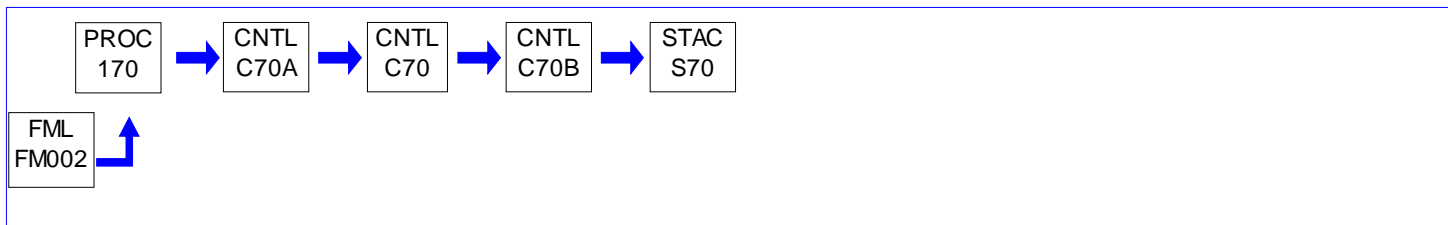
**I. RESTRICTIONS.**

No additional requirements exist except as provided in other sections of this permit including Section B (Title V General Requirements) and/or Section E (Source Group Restrictions).

II. TESTING REQUIREMENTS.

No additional testing requirements exist except as provided in other sections of this permit including Section B (Title V General Requirements) and/or Section E (Source Group Restrictions).

III. MONITORING REQUIREMENTS.

No additional monitoring requirements exist except as provided in other sections of this permit including Section B (Title V General Requirements) and/or Section E (Source Group Restrictions).

IV. RECORDKEEPING REQUIREMENTS.

No additional record keeping requirements exist except as provided in other sections of this permit including Section B (Title V General Requirements) and/or Section E (Source Group Restrictions).

V. REPORTING REQUIREMENTS.

No additional reporting requirements exist except as provided in other sections of this permit including Section B (Title V General Requirements) and/or Section E (Source Group Restrictions).

VI. WORK PRACTICE REQUIREMENTS.

No additional work practice requirements exist except as provided in other sections of this permit including Section B (Title V General Requirements) and/or Section E (Source Group Restrictions).

VII. ADDITIONAL REQUIREMENTS.

No additional requirements exist except as provided in other sections of this permit including Section B (Title V General Requirements) and/or Section E (Source Group Restrictions).

***** Permit Shield in Effect. *****

**SECTION D. Source Level Requirements**

Source ID: 179

Source Name: S-1 BATTERY ASSEMBLY (SCIENTIFIC FC #6)

Source Capacity/Throughput:

Conditions for this source occur in the following groups: SG 06 S-1 BATTERY ASSEMBLY
SG12 BAGHOUSE CAM

**I. RESTRICTIONS.**

No additional requirements exist except as provided in other sections of this permit including Section B (Title V General Requirements) and/or Section E (Source Group Restrictions).

II. TESTING REQUIREMENTS.

No additional testing requirements exist except as provided in other sections of this permit including Section B (Title V General Requirements) and/or Section E (Source Group Restrictions).

III. MONITORING REQUIREMENTS.

No additional monitoring requirements exist except as provided in other sections of this permit including Section B (Title V General Requirements) and/or Section E (Source Group Restrictions).

IV. RECORDKEEPING REQUIREMENTS.

No additional record keeping requirements exist except as provided in other sections of this permit including Section B (Title V General Requirements) and/or Section E (Source Group Restrictions).

V. REPORTING REQUIREMENTS.

No additional reporting requirements exist except as provided in other sections of this permit including Section B (Title V General Requirements) and/or Section E (Source Group Restrictions).

VI. WORK PRACTICE REQUIREMENTS.

No additional work practice requirements exist except as provided in other sections of this permit including Section B (Title V General Requirements) and/or Section E (Source Group Restrictions).

VII. ADDITIONAL REQUIREMENTS.

No additional requirements exist except as provided in other sections of this permit including Section B (Title V General Requirements) and/or Section E (Source Group Restrictions).

***** Permit Shield in Effect. *****

**SECTION D. Source Level Requirements**

Source ID: 181

Source Name: S-1 BATTERY ASSMBLY & DRY CHARGE (SCIEN FC #3)

Source Capacity/Throughput: 300.000 Each/HR STORAGE BATTERIES

Conditions for this source occur in the following groups: SG 06 S-1 BATTERY ASSEMBLY
SG12 BAGHOUSE CAM

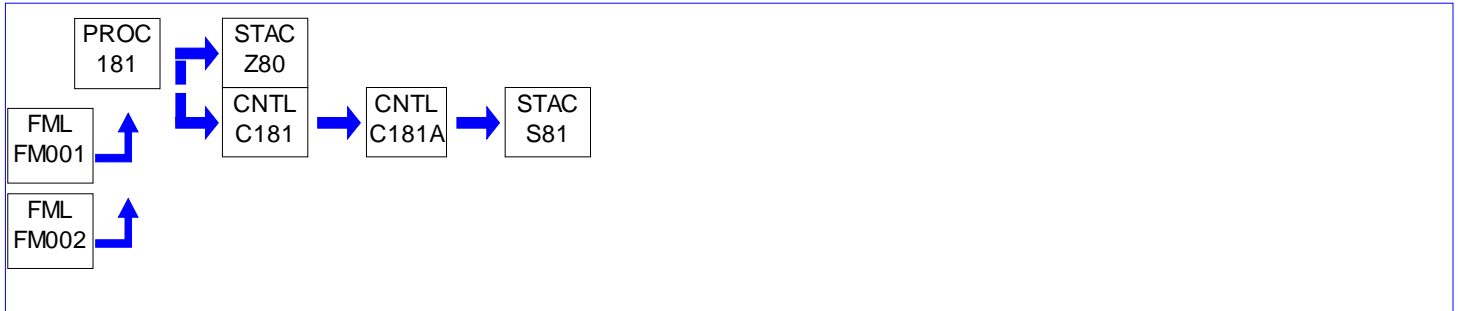
**I. RESTRICTIONS.**

No additional requirements exist except as provided in other sections of this permit including Section B (Title V General Requirements) and/or Section E (Source Group Restrictions).

II. TESTING REQUIREMENTS.

No additional testing requirements exist except as provided in other sections of this permit including Section B (Title V General Requirements) and/or Section E (Source Group Restrictions).

III. MONITORING REQUIREMENTS.

No additional monitoring requirements exist except as provided in other sections of this permit including Section B (Title V General Requirements) and/or Section E (Source Group Restrictions).

IV. RECORDKEEPING REQUIREMENTS.

No additional record keeping requirements exist except as provided in other sections of this permit including Section B (Title V General Requirements) and/or Section E (Source Group Restrictions).

V. REPORTING REQUIREMENTS.

No additional reporting requirements exist except as provided in other sections of this permit including Section B (Title V General Requirements) and/or Section E (Source Group Restrictions).

VI. WORK PRACTICE REQUIREMENTS.

No additional work practice requirements exist except as provided in other sections of this permit including Section B (Title V General Requirements) and/or Section E (Source Group Restrictions).

VII. ADDITIONAL REQUIREMENTS.

No additional requirements exist except as provided in other sections of this permit including Section B (Title V General Requirements) and/or Section E (Source Group Restrictions).

***** Permit Shield in Effect. *****

**SECTION D. Source Level Requirements**

Source ID: 182

Source Name: S-1 GRIDCAST (SCIENTIFIC FC #1)

Source Capacity/Throughput: 300.000 Each/HR STORAGE BATTERIES

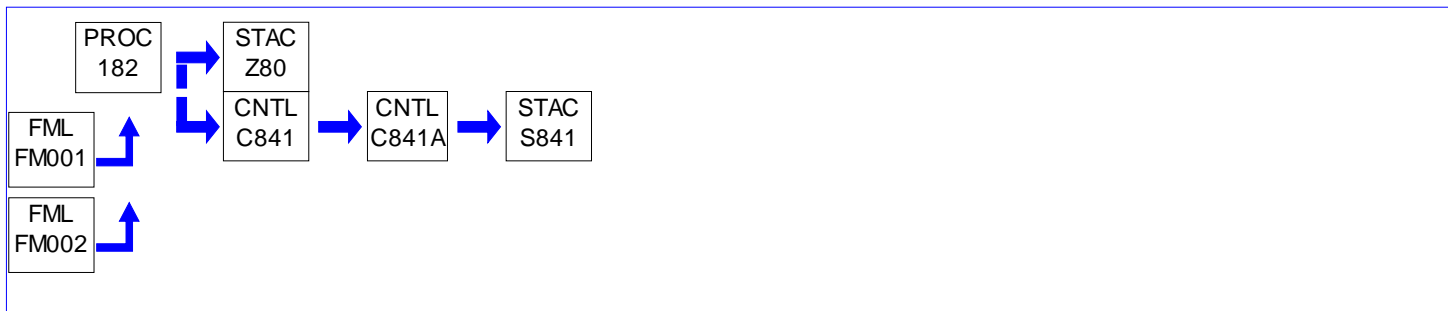
Conditions for this source occur in the following groups: SG 06 S-1 BATTERY ASSEMBLY
SG12 BAGHOUSE CAM**I. RESTRICTIONS.**

No additional requirements exist except as provided in other sections of this permit including Section B (Title V General Requirements) and/or Section E (Source Group Restrictions).

II. TESTING REQUIREMENTS.

No additional testing requirements exist except as provided in other sections of this permit including Section B (Title V General Requirements) and/or Section E (Source Group Restrictions).

III. MONITORING REQUIREMENTS.

No additional monitoring requirements exist except as provided in other sections of this permit including Section B (Title V General Requirements) and/or Section E (Source Group Restrictions).

IV. RECORDKEEPING REQUIREMENTS.

No additional record keeping requirements exist except as provided in other sections of this permit including Section B (Title V General Requirements) and/or Section E (Source Group Restrictions).

V. REPORTING REQUIREMENTS.

No additional reporting requirements exist except as provided in other sections of this permit including Section B (Title V General Requirements) and/or Section E (Source Group Restrictions).

VI. WORK PRACTICE REQUIREMENTS.

No additional work practice requirements exist except as provided in other sections of this permit including Section B (Title V General Requirements) and/or Section E (Source Group Restrictions).

VII. ADDITIONAL REQUIREMENTS.

No additional requirements exist except as provided in other sections of this permit including Section B (Title V General Requirements) and/or Section E (Source Group Restrictions).

***** Permit Shield in Effect. *****

**SECTION D. Source Level Requirements**

Source ID: 182A

Source Name: S-1 CONCAST (SCIENTIFIC FC #1)

Source Capacity/Throughput: 300.000 Each/HR STORAGE BATTERIES

Conditions for this source occur in the following groups: SG 06 S-1 BATTERY ASSEMBLY
 SG10B RACT 2
 SG12 BAGHOUSE CAM
 SG20 RACT III PRESUMPTIVE

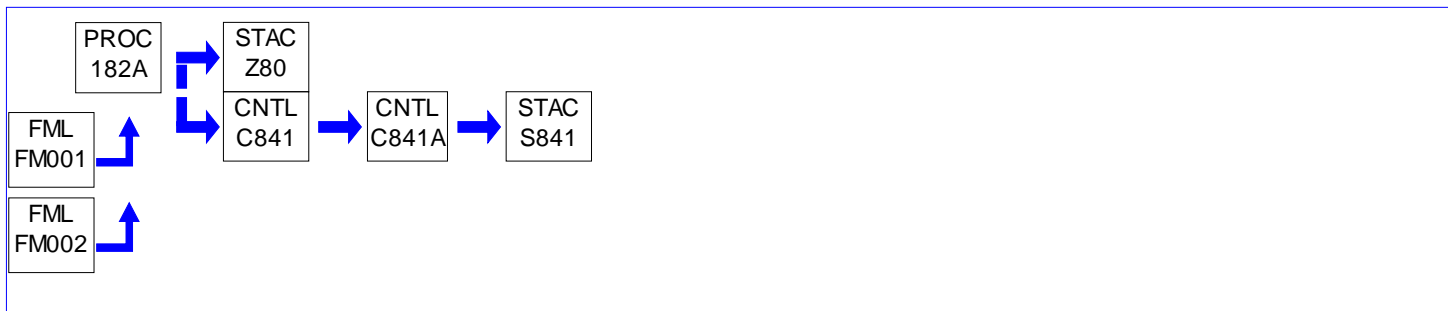
**I. RESTRICTIONS.**

No additional requirements exist except as provided in other sections of this permit including Section B (Title V General Requirements) and/or Section E (Source Group Restrictions).

II. TESTING REQUIREMENTS.

No additional testing requirements exist except as provided in other sections of this permit including Section B (Title V General Requirements) and/or Section E (Source Group Restrictions).

III. MONITORING REQUIREMENTS.

No additional monitoring requirements exist except as provided in other sections of this permit including Section B (Title V General Requirements) and/or Section E (Source Group Restrictions).

IV. RECORDKEEPING REQUIREMENTS.

No additional record keeping requirements exist except as provided in other sections of this permit including Section B (Title V General Requirements) and/or Section E (Source Group Restrictions).

V. REPORTING REQUIREMENTS.

No additional reporting requirements exist except as provided in other sections of this permit including Section B (Title V General Requirements) and/or Section E (Source Group Restrictions).

VI. WORK PRACTICE REQUIREMENTS.

No additional work practice requirements exist except as provided in other sections of this permit including Section B (Title V General Requirements) and/or Section E (Source Group Restrictions).

VII. ADDITIONAL REQUIREMENTS.

No additional requirements exist except as provided in other sections of this permit including Section B (Title V General Requirements) and/or Section E (Source Group Restrictions).



SECTION D. Source Level Requirements

***** Permit Shield in Effect. *****

**SECTION D. Source Level Requirements**

Source ID: 183

Source Name: S-1 GROUP ASSEMBLY (SCIENTIFIC FC #2)

Source Capacity/Throughput: 300.000 Each/HR STORAGE BATTERIES

Conditions for this source occur in the following groups: SG 06 S-1 BATTERY ASSEMBLY
SG12 BAGHOUSE CAM

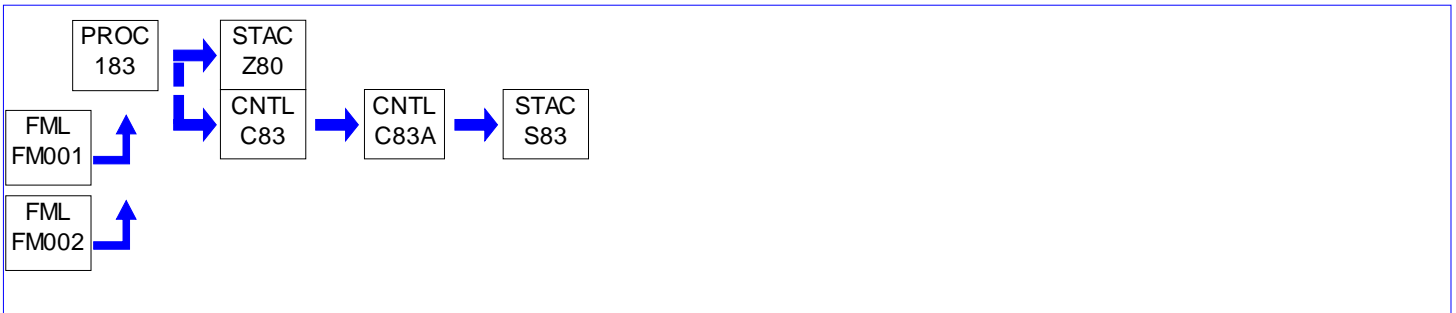
**I. RESTRICTIONS.**

No additional requirements exist except as provided in other sections of this permit including Section B (Title V General Requirements) and/or Section E (Source Group Restrictions).

II. TESTING REQUIREMENTS.

No additional testing requirements exist except as provided in other sections of this permit including Section B (Title V General Requirements) and/or Section E (Source Group Restrictions).

III. MONITORING REQUIREMENTS.

No additional monitoring requirements exist except as provided in other sections of this permit including Section B (Title V General Requirements) and/or Section E (Source Group Restrictions).

IV. RECORDKEEPING REQUIREMENTS.

No additional record keeping requirements exist except as provided in other sections of this permit including Section B (Title V General Requirements) and/or Section E (Source Group Restrictions).

V. REPORTING REQUIREMENTS.

No additional reporting requirements exist except as provided in other sections of this permit including Section B (Title V General Requirements) and/or Section E (Source Group Restrictions).

VI. WORK PRACTICE REQUIREMENTS.

No additional work practice requirements exist except as provided in other sections of this permit including Section B (Title V General Requirements) and/or Section E (Source Group Restrictions).

VII. ADDITIONAL REQUIREMENTS.

No additional requirements exist except as provided in other sections of this permit including Section B (Title V General Requirements) and/or Section E (Source Group Restrictions).

***** Permit Shield in Effect. *****



SECTION D. Source Level Requirements

Source ID: 184

Source Name: S-1 MIXING (SCIENTIFIC FC #1) & PASTING (SCIENTIFIC FC #4)

Source Capacity/Throughput: 300.000 Each/HR STORAGE BATTERIES

Conditions for this source occur in the following groups: SG 06 S-1 BATTERY ASSEMBLY
SG12 BAGHOUSE CAM

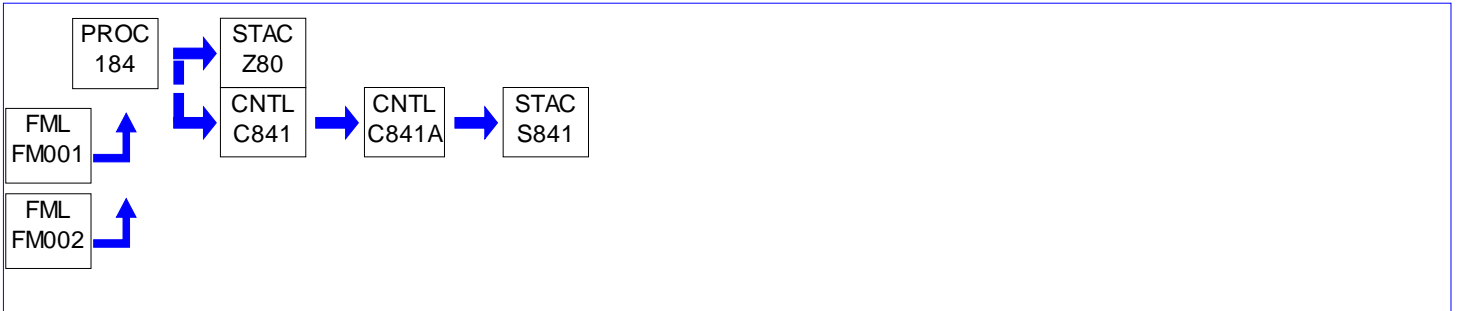

I. RESTRICTIONS.

No additional requirements exist except as provided in other sections of this permit including Section B (Title V General Requirements) and/or Section E (Source Group Restrictions).

II. TESTING REQUIREMENTS.

No additional testing requirements exist except as provided in other sections of this permit including Section B (Title V General Requirements) and/or Section E (Source Group Restrictions).

III. MONITORING REQUIREMENTS.

No additional monitoring requirements exist except as provided in other sections of this permit including Section B (Title V General Requirements) and/or Section E (Source Group Restrictions).

IV. RECORDKEEPING REQUIREMENTS.

No additional record keeping requirements exist except as provided in other sections of this permit including Section B (Title V General Requirements) and/or Section E (Source Group Restrictions).

V. REPORTING REQUIREMENTS.

No additional reporting requirements exist except as provided in other sections of this permit including Section B (Title V General Requirements) and/or Section E (Source Group Restrictions).

VI. WORK PRACTICE REQUIREMENTS.

No additional work practice requirements exist except as provided in other sections of this permit including Section B (Title V General Requirements) and/or Section E (Source Group Restrictions).

VII. ADDITIONAL REQUIREMENTS.

No additional requirements exist except as provided in other sections of this permit including Section B (Title V General Requirements) and/or Section E (Source Group Restrictions).

***** Permit Shield in Effect. *****

**SECTION D. Source Level Requirements**

Source ID: 185

Source Name: S-1 LEAD OXIDE STORAGE SILOS (3) (BIN VENTS)

Source Capacity/Throughput: 15.000 Tons/HR LEAD OXIDE

Conditions for this source occur in the following groups: SG 06 S-1 BATTERY ASSEMBLY

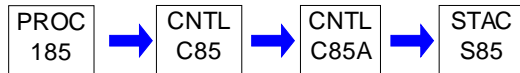
**I. RESTRICTIONS.**

No additional requirements exist except as provided in other sections of this permit including Section B (Title V General Requirements) and/or Section E (Source Group Restrictions).

II. TESTING REQUIREMENTS.

No additional testing requirements exist except as provided in other sections of this permit including Section B (Title V General Requirements) and/or Section E (Source Group Restrictions).

III. MONITORING REQUIREMENTS.

No additional monitoring requirements exist except as provided in other sections of this permit including Section B (Title V General Requirements) and/or Section E (Source Group Restrictions).

IV. RECORDKEEPING REQUIREMENTS.

No additional record keeping requirements exist except as provided in other sections of this permit including Section B (Title V General Requirements) and/or Section E (Source Group Restrictions).

V. REPORTING REQUIREMENTS.

No additional reporting requirements exist except as provided in other sections of this permit including Section B (Title V General Requirements) and/or Section E (Source Group Restrictions).

VI. WORK PRACTICE REQUIREMENTS.

No additional work practice requirements exist except as provided in other sections of this permit including Section B (Title V General Requirements) and/or Section E (Source Group Restrictions).

VII. ADDITIONAL REQUIREMENTS.

No additional requirements exist except as provided in other sections of this permit including Section B (Title V General Requirements) and/or Section E (Source Group Restrictions).

***** Permit Shield in Effect. *****

**SECTION D. Source Level Requirements**

Source ID: 186

Source Name: S-1 BATTERY ACTTN/BOOSTIN (5 MIST ELIM)

Source Capacity/Throughput: 300.000 Each/HR STORAGE BATTERIES

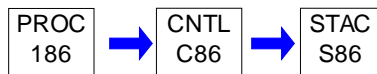
Conditions for this source occur in the following groups: SG 06 S-1 BATTERY ASSEMBLY
SG17 MIST ELIMINATOR CAM**I. RESTRICTIONS.**

No additional requirements exist except as provided in other sections of this permit including Section B (Title V General Requirements) and/or Section E (Source Group Restrictions).

II. TESTING REQUIREMENTS.

No additional testing requirements exist except as provided in other sections of this permit including Section B (Title V General Requirements) and/or Section E (Source Group Restrictions).

III. MONITORING REQUIREMENTS.

No additional monitoring requirements exist except as provided in other sections of this permit including Section B (Title V General Requirements) and/or Section E (Source Group Restrictions).

IV. RECORDKEEPING REQUIREMENTS.

No additional record keeping requirements exist except as provided in other sections of this permit including Section B (Title V General Requirements) and/or Section E (Source Group Restrictions).

V. REPORTING REQUIREMENTS.

No additional reporting requirements exist except as provided in other sections of this permit including Section B (Title V General Requirements) and/or Section E (Source Group Restrictions).

VI. WORK PRACTICE REQUIREMENTS.

No additional work practice requirements exist except as provided in other sections of this permit including Section B (Title V General Requirements) and/or Section E (Source Group Restrictions).

VII. ADDITIONAL REQUIREMENTS.

No additional requirements exist except as provided in other sections of this permit including Section B (Title V General Requirements) and/or Section E (Source Group Restrictions).

***** Permit Shield in Effect. *****

**SECTION D. Source Level Requirements**

Source ID: 187

Source Name: S- 1 BATT FORMATION (10 MIST ELIM)

Source Capacity/Throughput: 300.000 Each/HR STORAGE BATTERIES

Conditions for this source occur in the following groups: SG 06 S-1 BATTERY ASSEMBLY
SG17 MIST ELIMINATOR CAM

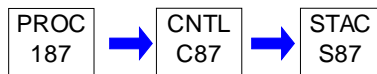
**I. RESTRICTIONS.**

No additional requirements exist except as provided in other sections of this permit including Section B (Title V General Requirements) and/or Section E (Source Group Restrictions).

II. TESTING REQUIREMENTS.

No additional testing requirements exist except as provided in other sections of this permit including Section B (Title V General Requirements) and/or Section E (Source Group Restrictions).

III. MONITORING REQUIREMENTS.

No additional monitoring requirements exist except as provided in other sections of this permit including Section B (Title V General Requirements) and/or Section E (Source Group Restrictions).

IV. RECORDKEEPING REQUIREMENTS.

No additional record keeping requirements exist except as provided in other sections of this permit including Section B (Title V General Requirements) and/or Section E (Source Group Restrictions).

V. REPORTING REQUIREMENTS.

No additional reporting requirements exist except as provided in other sections of this permit including Section B (Title V General Requirements) and/or Section E (Source Group Restrictions).

VI. WORK PRACTICE REQUIREMENTS.

No additional work practice requirements exist except as provided in other sections of this permit including Section B (Title V General Requirements) and/or Section E (Source Group Restrictions).

VII. ADDITIONAL REQUIREMENTS.

No additional requirements exist except as provided in other sections of this permit including Section B (Title V General Requirements) and/or Section E (Source Group Restrictions).

***** Permit Shield in Effect. *****

**SECTION D. Source Level Requirements**

Source ID: 188

Source Name: S-1 UNIGY & GEL BATT ASSEM (SCIENTIFIC FC #5)

Source Capacity/Throughput: 300.000 Each/HR STORAGE BATTERIES

Conditions for this source occur in the following groups: SG 06 S-1 BATTERY ASSEMBLY
SG12 BAGHOUSE CAM

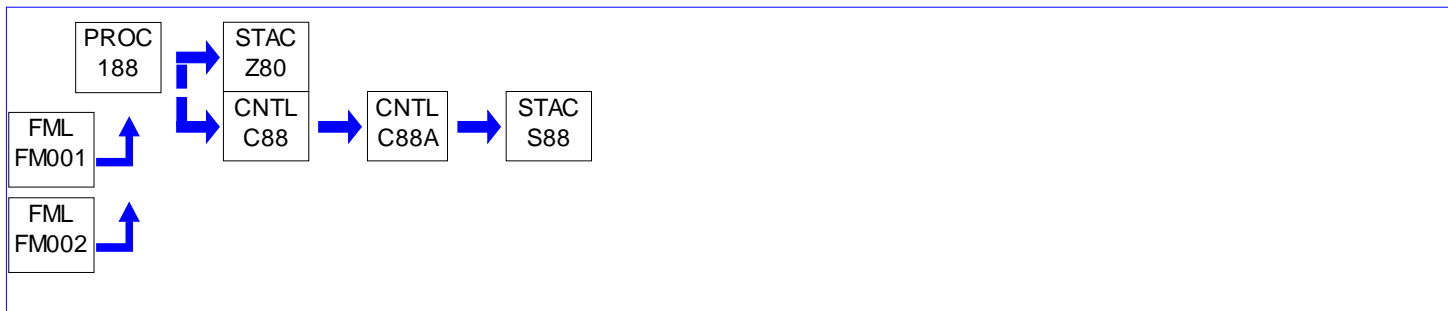
**I. RESTRICTIONS.**

No additional requirements exist except as provided in other sections of this permit including Section B (Title V General Requirements) and/or Section E (Source Group Restrictions).

II. TESTING REQUIREMENTS.

No additional testing requirements exist except as provided in other sections of this permit including Section B (Title V General Requirements) and/or Section E (Source Group Restrictions).

III. MONITORING REQUIREMENTS.

No additional monitoring requirements exist except as provided in other sections of this permit including Section B (Title V General Requirements) and/or Section E (Source Group Restrictions).

IV. RECORDKEEPING REQUIREMENTS.

No additional record keeping requirements exist except as provided in other sections of this permit including Section B (Title V General Requirements) and/or Section E (Source Group Restrictions).

V. REPORTING REQUIREMENTS.

No additional reporting requirements exist except as provided in other sections of this permit including Section B (Title V General Requirements) and/or Section E (Source Group Restrictions).

VI. WORK PRACTICE REQUIREMENTS.

No additional work practice requirements exist except as provided in other sections of this permit including Section B (Title V General Requirements) and/or Section E (Source Group Restrictions).

VII. ADDITIONAL REQUIREMENTS.

No additional requirements exist except as provided in other sections of this permit including Section B (Title V General Requirements) and/or Section E (Source Group Restrictions).

***** Permit Shield in Effect. *****

**SECTION D. Source Level Requirements**

Source ID: 189

Source Name: S-1 GROUP ASSEMBLY (SCIENTIFIC FC #4)

Source Capacity/Throughput: 300.000 Each/HR STORAGE BATTERIES

Conditions for this source occur in the following groups: SG 06 S-1 BATTERY ASSEMBLY
SG12 BAGHOUSE CAM

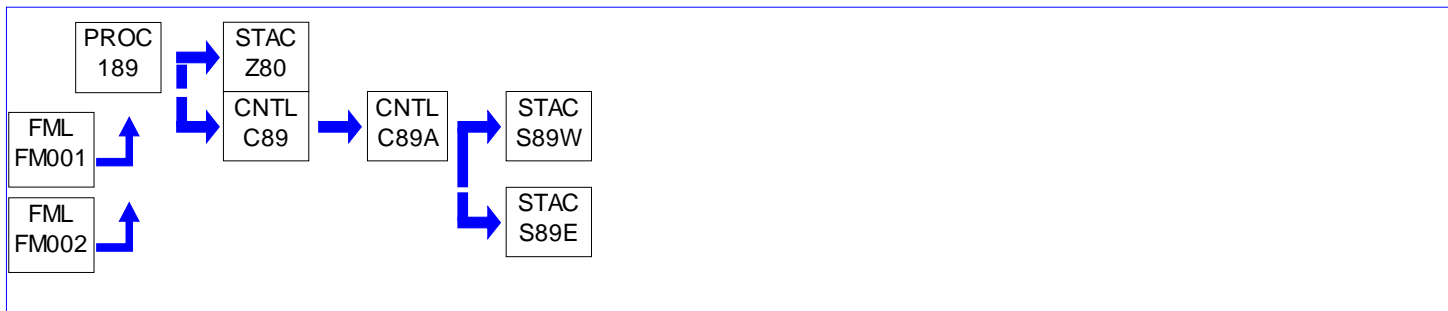
**I. RESTRICTIONS.**

No additional requirements exist except as provided in other sections of this permit including Section B (Title V General Requirements) and/or Section E (Source Group Restrictions).

II. TESTING REQUIREMENTS.

No additional testing requirements exist except as provided in other sections of this permit including Section B (Title V General Requirements) and/or Section E (Source Group Restrictions).

III. MONITORING REQUIREMENTS.

No additional monitoring requirements exist except as provided in other sections of this permit including Section B (Title V General Requirements) and/or Section E (Source Group Restrictions).

IV. RECORDKEEPING REQUIREMENTS.

No additional record keeping requirements exist except as provided in other sections of this permit including Section B (Title V General Requirements) and/or Section E (Source Group Restrictions).

V. REPORTING REQUIREMENTS.

No additional reporting requirements exist except as provided in other sections of this permit including Section B (Title V General Requirements) and/or Section E (Source Group Restrictions).

VI. WORK PRACTICE REQUIREMENTS.

No additional work practice requirements exist except as provided in other sections of this permit including Section B (Title V General Requirements) and/or Section E (Source Group Restrictions).

VII. ADDITIONAL REQUIREMENTS.

No additional requirements exist except as provided in other sections of this permit including Section B (Title V General Requirements) and/or Section E (Source Group Restrictions).

***** Permit Shield in Effect. *****

**SECTION D. Source Level Requirements**

Source ID: 191

Source Name: A-3- BATTERY FORMATION (9 MIST ELIM)

Source Capacity/Throughput: 500.000 Each/HR STORAGE BATTERIES

Conditions for this source occur in the following groups: SG 03 A-3 BATTERY ASSEMBLY
SG17 MIST ELIMINATOR CAM

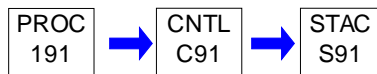
**I. RESTRICTIONS.**

No additional requirements exist except as provided in other sections of this permit including Section B (Title V General Requirements) and/or Section E (Source Group Restrictions).

II. TESTING REQUIREMENTS.

No additional testing requirements exist except as provided in other sections of this permit including Section B (Title V General Requirements) and/or Section E (Source Group Restrictions).

III. MONITORING REQUIREMENTS.

No additional monitoring requirements exist except as provided in other sections of this permit including Section B (Title V General Requirements) and/or Section E (Source Group Restrictions).

IV. RECORDKEEPING REQUIREMENTS.

No additional record keeping requirements exist except as provided in other sections of this permit including Section B (Title V General Requirements) and/or Section E (Source Group Restrictions).

V. REPORTING REQUIREMENTS.

No additional reporting requirements exist except as provided in other sections of this permit including Section B (Title V General Requirements) and/or Section E (Source Group Restrictions).

VI. WORK PRACTICE REQUIREMENTS.

No additional work practice requirements exist except as provided in other sections of this permit including Section B (Title V General Requirements) and/or Section E (Source Group Restrictions).

VII. ADDITIONAL REQUIREMENTS.

No additional requirements exist except as provided in other sections of this permit including Section B (Title V General Requirements) and/or Section E (Source Group Restrictions).

***** Permit Shield in Effect. *****

**SECTION D. Source Level Requirements**

Source ID: 191A

Source Name: A-3 BATTERY FORMATION HEATING

Source Capacity/Throughput:

**I. RESTRICTIONS.****Fuel Restriction(s).**

001 [25 Pa. Code §127.441]

Operating permit terms and conditions.

Natural gas, propane/air mixture or a combination of both shall be the only fuels for Source 191A units.

II. TESTING REQUIREMENTS.

No additional testing requirements exist except as provided in other sections of this permit including Section B (Title V General Requirements).

III. MONITORING REQUIREMENTS.

No additional monitoring requirements exist except as provided in other sections of this permit including Section B (Title V General Requirements).

IV. RECORDKEEPING REQUIREMENTS.

002 [25 Pa. Code §127.441]

Operating permit terms and conditions.

The permittee shall maintain records of the fuel consumption by Source 191A units. The records shall be maintained for a period of five (5) years. The records shall be available to the Department on request and shall contain at a minimum the following information:

- i. Monthly natural gas consumption
- ii. 12-month rolling total of natural gas consumption

V. REPORTING REQUIREMENTS.

No additional reporting requirements exist except as provided in other sections of this permit including Section B (Title V General Requirements).

VI. WORK PRACTICE REQUIREMENTS.

003 [25 Pa. Code §127.441]

Operating permit terms and conditions.The permittee shall operate all of the Source 191A units in accordance with good combustion practices (e.g. operating sources in accordance with manufacturer specifications and preventative maintenance procedures) to limit the NO_x, CO and VOC emissions.

**SECTION D. Source Level Requirements****VII. ADDITIONAL REQUIREMENTS.**

No additional requirements exist except as provided in other sections of this permit including Section B (Title V General Requirements).

***** Permit Shield in Effect. *****

**SECTION D. Source Level Requirements**

Source ID: 192

Source Name: A-1 BURN & STACK (SCIENTIFIC FC 5)

Source Capacity/Throughput: 200.000 Each/HR STORAGE BATTERIES

Conditions for this source occur in the following groups: SG 01 A-1 BATTERY ASSEMBLY
SG12 BAGHOUSE CAM

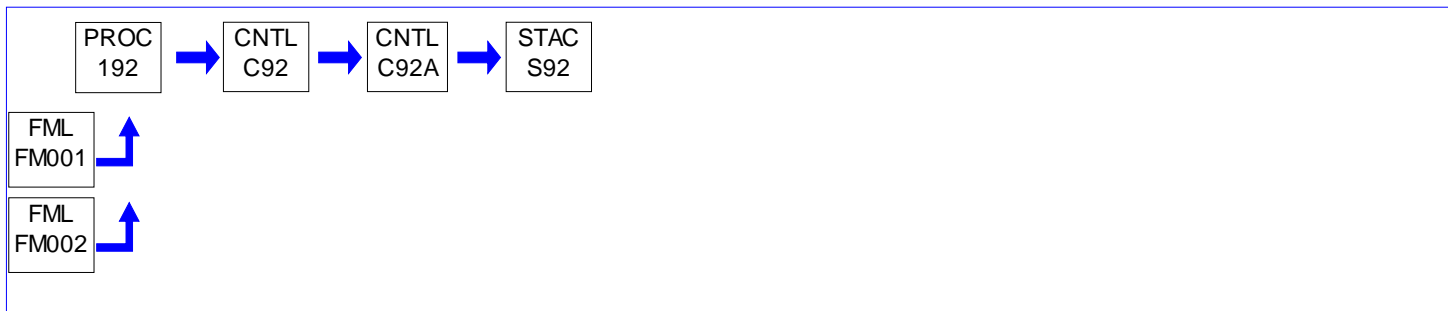
**I. RESTRICTIONS.**

No additional requirements exist except as provided in other sections of this permit including Section B (Title V General Requirements) and/or Section E (Source Group Restrictions).

II. TESTING REQUIREMENTS.

No additional testing requirements exist except as provided in other sections of this permit including Section B (Title V General Requirements) and/or Section E (Source Group Restrictions).

III. MONITORING REQUIREMENTS.

No additional monitoring requirements exist except as provided in other sections of this permit including Section B (Title V General Requirements) and/or Section E (Source Group Restrictions).

IV. RECORDKEEPING REQUIREMENTS.

No additional record keeping requirements exist except as provided in other sections of this permit including Section B (Title V General Requirements) and/or Section E (Source Group Restrictions).

V. REPORTING REQUIREMENTS.

No additional reporting requirements exist except as provided in other sections of this permit including Section B (Title V General Requirements) and/or Section E (Source Group Restrictions).

VI. WORK PRACTICE REQUIREMENTS.

No additional work practice requirements exist except as provided in other sections of this permit including Section B (Title V General Requirements) and/or Section E (Source Group Restrictions).

VII. ADDITIONAL REQUIREMENTS.

No additional requirements exist except as provided in other sections of this permit including Section B (Title V General Requirements) and/or Section E (Source Group Restrictions).

***** Permit Shield in Effect. *****

**SECTION D. Source Level Requirements**

Source ID: 193

Source Name: A-2 GROUP ASSEMBLY 1 (SCIENTIFIC FC 5)

Source Capacity/Throughput: 1,100.000 Each/HR STORAGE BATTERIES

Conditions for this source occur in the following groups: SG 02 A-2 BATTERY ASSEMBLY
SG12 BAGHOUSE CAM

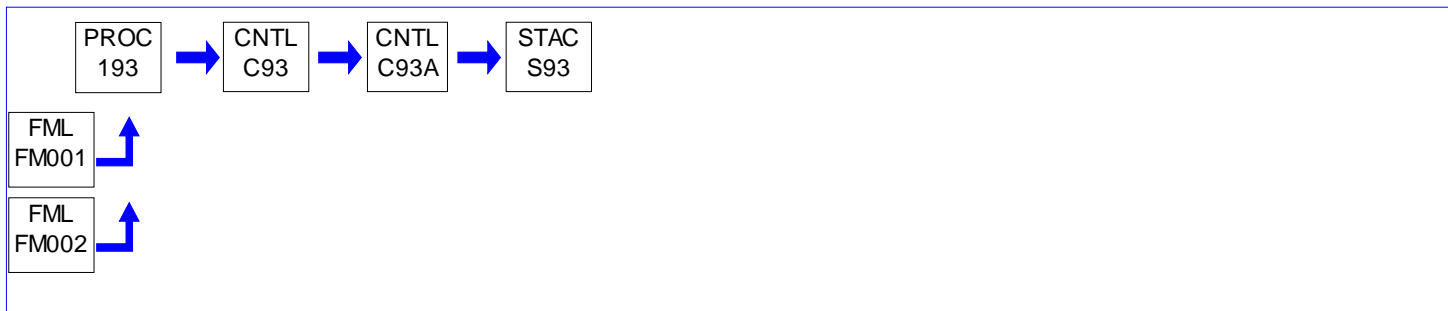
**I. RESTRICTIONS.**

No additional requirements exist except as provided in other sections of this permit including Section B (Title V General Requirements) and/or Section E (Source Group Restrictions).

II. TESTING REQUIREMENTS.

No additional testing requirements exist except as provided in other sections of this permit including Section B (Title V General Requirements) and/or Section E (Source Group Restrictions).

III. MONITORING REQUIREMENTS.

No additional monitoring requirements exist except as provided in other sections of this permit including Section B (Title V General Requirements) and/or Section E (Source Group Restrictions).

IV. RECORDKEEPING REQUIREMENTS.

No additional record keeping requirements exist except as provided in other sections of this permit including Section B (Title V General Requirements) and/or Section E (Source Group Restrictions).

V. REPORTING REQUIREMENTS.

No additional reporting requirements exist except as provided in other sections of this permit including Section B (Title V General Requirements) and/or Section E (Source Group Restrictions).

VI. WORK PRACTICE REQUIREMENTS.

No additional work practice requirements exist except as provided in other sections of this permit including Section B (Title V General Requirements) and/or Section E (Source Group Restrictions).

VII. ADDITIONAL REQUIREMENTS.

No additional requirements exist except as provided in other sections of this permit including Section B (Title V General Requirements) and/or Section E (Source Group Restrictions).

***** Permit Shield in Effect. *****

**SECTION D. Source Level Requirements**

Source ID: 194

Source Name: A-2 GROUP ASSEMBLY 2 (SCIENTIFIC FC 6)

Source Capacity/Throughput: 1,100.000 Each/HR STORAGE BATTERIES

Conditions for this source occur in the following groups: SG 02 A-2 BATTERY ASSEMBLY
SG12 BAGHOUSE CAM

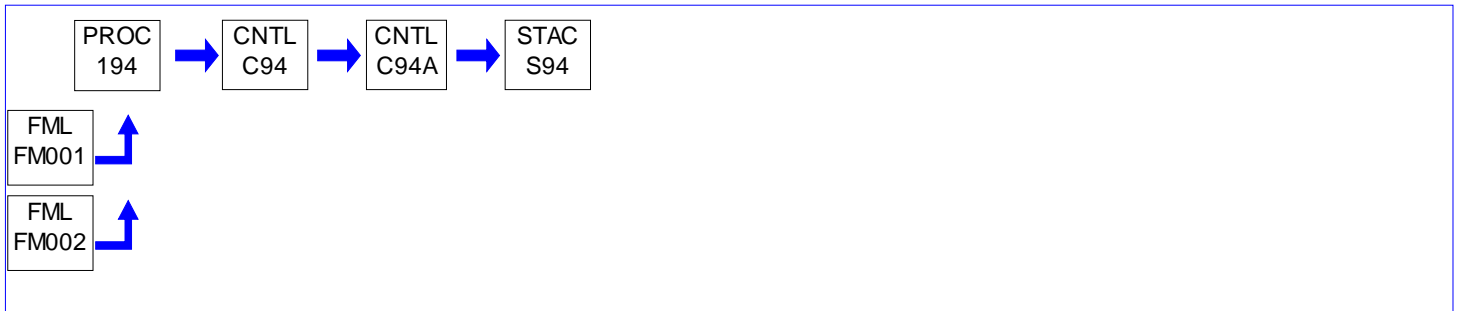
**I. RESTRICTIONS.**

No additional requirements exist except as provided in other sections of this permit including Section B (Title V General Requirements) and/or Section E (Source Group Restrictions).

II. TESTING REQUIREMENTS.

No additional testing requirements exist except as provided in other sections of this permit including Section B (Title V General Requirements) and/or Section E (Source Group Restrictions).

III. MONITORING REQUIREMENTS.

No additional monitoring requirements exist except as provided in other sections of this permit including Section B (Title V General Requirements) and/or Section E (Source Group Restrictions).

IV. RECORDKEEPING REQUIREMENTS.

No additional record keeping requirements exist except as provided in other sections of this permit including Section B (Title V General Requirements) and/or Section E (Source Group Restrictions).

V. REPORTING REQUIREMENTS.

No additional reporting requirements exist except as provided in other sections of this permit including Section B (Title V General Requirements) and/or Section E (Source Group Restrictions).

VI. WORK PRACTICE REQUIREMENTS.

No additional work practice requirements exist except as provided in other sections of this permit including Section B (Title V General Requirements) and/or Section E (Source Group Restrictions).

VII. ADDITIONAL REQUIREMENTS.

No additional requirements exist except as provided in other sections of this permit including Section B (Title V General Requirements) and/or Section E (Source Group Restrictions).

***** Permit Shield in Effect. *****

**SECTION D. Source Level Requirements**

Source ID: 195

Source Name: A-2 GROUP ASSEMBLY 3 (SCIENTIFIC FC 7)

Source Capacity/Throughput: 1,100.000 Each/HR STORAGE BATTERIES

Conditions for this source occur in the following groups: SG 02 A-2 BATTERY ASSEMBLY
SG12 BAGHOUSE CAM

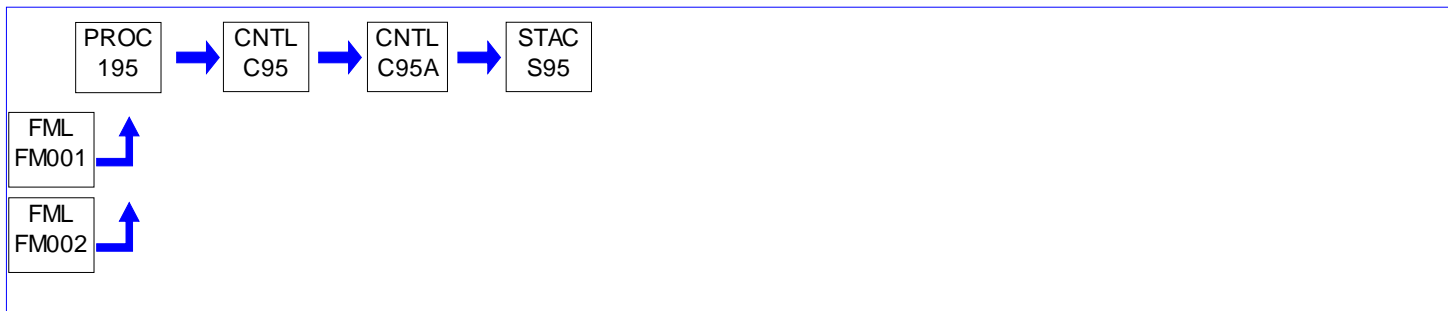
**I. RESTRICTIONS.**

No additional requirements exist except as provided in other sections of this permit including Section B (Title V General Requirements) and/or Section E (Source Group Restrictions).

II. TESTING REQUIREMENTS.

No additional testing requirements exist except as provided in other sections of this permit including Section B (Title V General Requirements) and/or Section E (Source Group Restrictions).

III. MONITORING REQUIREMENTS.

No additional monitoring requirements exist except as provided in other sections of this permit including Section B (Title V General Requirements) and/or Section E (Source Group Restrictions).

IV. RECORDKEEPING REQUIREMENTS.

No additional record keeping requirements exist except as provided in other sections of this permit including Section B (Title V General Requirements) and/or Section E (Source Group Restrictions).

V. REPORTING REQUIREMENTS.

No additional reporting requirements exist except as provided in other sections of this permit including Section B (Title V General Requirements) and/or Section E (Source Group Restrictions).

VI. WORK PRACTICE REQUIREMENTS.

No additional work practice requirements exist except as provided in other sections of this permit including Section B (Title V General Requirements) and/or Section E (Source Group Restrictions).

VII. ADDITIONAL REQUIREMENTS.

No additional requirements exist except as provided in other sections of this permit including Section B (Title V General Requirements) and/or Section E (Source Group Restrictions).

***** Permit Shield in Effect. *****

**SECTION D. Source Level Requirements**

Source ID: 196

Source Name: LEAD OXIDE MILL 11

Source Capacity/Throughput:	2,600.000 Lbs/HR	LEAD OXIDE
	750.000 CF/HR	Natural Gas

Conditions for this source occur in the following groups: SG 05 OXIDE PLANT

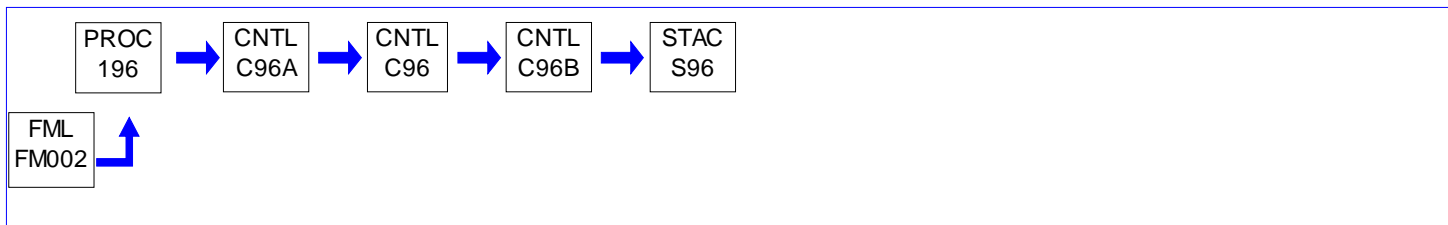
**I. RESTRICTIONS.**

No additional requirements exist except as provided in other sections of this permit including Section B (Title V General Requirements) and/or Section E (Source Group Restrictions).

II. TESTING REQUIREMENTS.

No additional testing requirements exist except as provided in other sections of this permit including Section B (Title V General Requirements) and/or Section E (Source Group Restrictions).

III. MONITORING REQUIREMENTS.

No additional monitoring requirements exist except as provided in other sections of this permit including Section B (Title V General Requirements) and/or Section E (Source Group Restrictions).

IV. RECORDKEEPING REQUIREMENTS.

No additional record keeping requirements exist except as provided in other sections of this permit including Section B (Title V General Requirements) and/or Section E (Source Group Restrictions).

V. REPORTING REQUIREMENTS.

No additional reporting requirements exist except as provided in other sections of this permit including Section B (Title V General Requirements) and/or Section E (Source Group Restrictions).

VI. WORK PRACTICE REQUIREMENTS.

No additional work practice requirements exist except as provided in other sections of this permit including Section B (Title V General Requirements) and/or Section E (Source Group Restrictions).

VII. ADDITIONAL REQUIREMENTS.

No additional requirements exist except as provided in other sections of this permit including Section B (Title V General Requirements) and/or Section E (Source Group Restrictions).

***** Permit Shield in Effect. *****

**SECTION D. Source Level Requirements**

Source ID: 197

Source Name: LEAD OXIDE MILL 12

Source Capacity/Throughput: 2,600.000 Lbs/HR
750.000 CF/HRLEAD OXIDE
Natural Gas

Conditions for this source occur in the following groups: SG 05 OXIDE PLANT

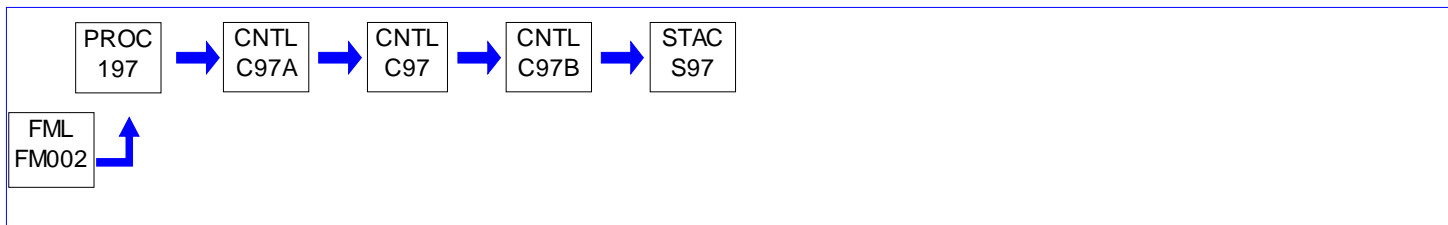
**I. RESTRICTIONS.**

No additional requirements exist except as provided in other sections of this permit including Section B (Title V General Requirements) and/or Section E (Source Group Restrictions).

II. TESTING REQUIREMENTS.

No additional testing requirements exist except as provided in other sections of this permit including Section B (Title V General Requirements) and/or Section E (Source Group Restrictions).

III. MONITORING REQUIREMENTS.

No additional monitoring requirements exist except as provided in other sections of this permit including Section B (Title V General Requirements) and/or Section E (Source Group Restrictions).

IV. RECORDKEEPING REQUIREMENTS.

No additional record keeping requirements exist except as provided in other sections of this permit including Section B (Title V General Requirements) and/or Section E (Source Group Restrictions).

V. REPORTING REQUIREMENTS.

No additional reporting requirements exist except as provided in other sections of this permit including Section B (Title V General Requirements) and/or Section E (Source Group Restrictions).

VI. WORK PRACTICE REQUIREMENTS.

No additional work practice requirements exist except as provided in other sections of this permit including Section B (Title V General Requirements) and/or Section E (Source Group Restrictions).

VII. ADDITIONAL REQUIREMENTS.

No additional requirements exist except as provided in other sections of this permit including Section B (Title V General Requirements) and/or Section E (Source Group Restrictions).

***** Permit Shield in Effect. *****

**SECTION D. Source Level Requirements**

Source ID: 198

Source Name: LEAD OXIDE MILL 13

Source Capacity/Throughput: 2,600.000 Lbs/HR
750.000 CF/HRLEAD OXIDE
Natural Gas

Conditions for this source occur in the following groups: SG 05 OXIDE PLANT

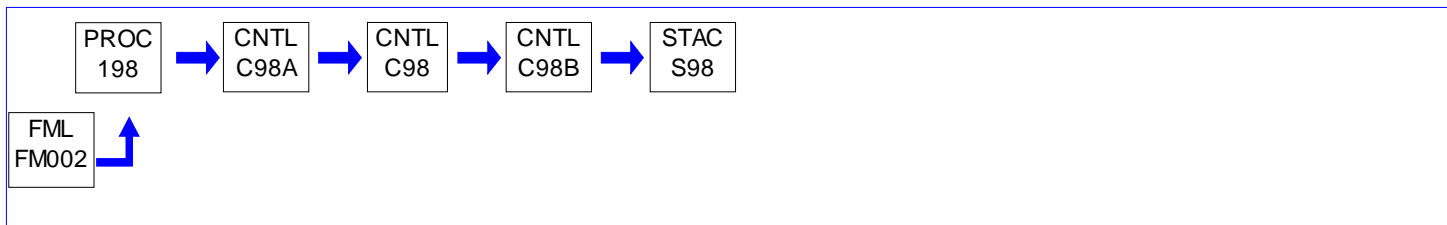
**I. RESTRICTIONS.**

No additional requirements exist except as provided in other sections of this permit including Section B (Title V General Requirements) and/or Section E (Source Group Restrictions).

II. TESTING REQUIREMENTS.

No additional testing requirements exist except as provided in other sections of this permit including Section B (Title V General Requirements) and/or Section E (Source Group Restrictions).

III. MONITORING REQUIREMENTS.

No additional monitoring requirements exist except as provided in other sections of this permit including Section B (Title V General Requirements) and/or Section E (Source Group Restrictions).

IV. RECORDKEEPING REQUIREMENTS.

No additional record keeping requirements exist except as provided in other sections of this permit including Section B (Title V General Requirements) and/or Section E (Source Group Restrictions).

V. REPORTING REQUIREMENTS.

No additional reporting requirements exist except as provided in other sections of this permit including Section B (Title V General Requirements) and/or Section E (Source Group Restrictions).

VI. WORK PRACTICE REQUIREMENTS.

No additional work practice requirements exist except as provided in other sections of this permit including Section B (Title V General Requirements) and/or Section E (Source Group Restrictions).

VII. ADDITIONAL REQUIREMENTS.

No additional requirements exist except as provided in other sections of this permit including Section B (Title V General Requirements) and/or Section E (Source Group Restrictions).

***** Permit Shield in Effect. *****

**SECTION D. Source Level Requirements**

Source ID: 199

Source Name: LEAD OXIDE MILL 14

Source Capacity/Throughput: 2,600.000 Lbs/HR
750.000 CF/HRLEAD OXIDE
Natural Gas

Conditions for this source occur in the following groups: SG 05 OXIDE PLANT

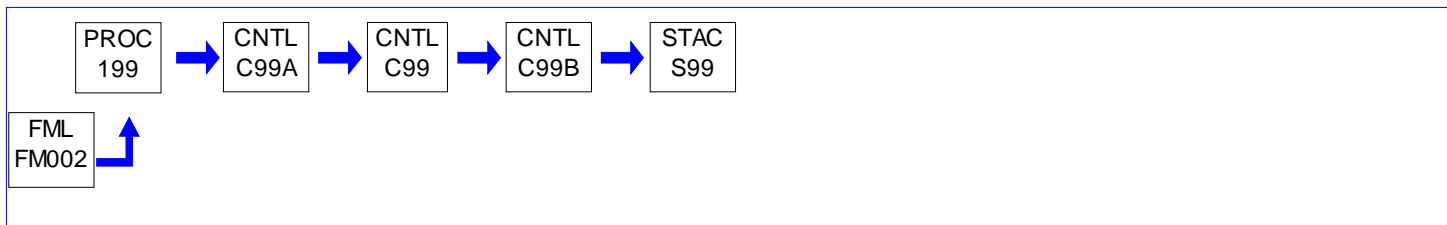
**I. RESTRICTIONS.**

No additional requirements exist except as provided in other sections of this permit including Section B (Title V General Requirements) and/or Section E (Source Group Restrictions).

II. TESTING REQUIREMENTS.

No additional testing requirements exist except as provided in other sections of this permit including Section B (Title V General Requirements) and/or Section E (Source Group Restrictions).

III. MONITORING REQUIREMENTS.

No additional monitoring requirements exist except as provided in other sections of this permit including Section B (Title V General Requirements) and/or Section E (Source Group Restrictions).

IV. RECORDKEEPING REQUIREMENTS.

No additional record keeping requirements exist except as provided in other sections of this permit including Section B (Title V General Requirements) and/or Section E (Source Group Restrictions).

V. REPORTING REQUIREMENTS.

No additional reporting requirements exist except as provided in other sections of this permit including Section B (Title V General Requirements) and/or Section E (Source Group Restrictions).

VI. WORK PRACTICE REQUIREMENTS.

No additional work practice requirements exist except as provided in other sections of this permit including Section B (Title V General Requirements) and/or Section E (Source Group Restrictions).

VII. ADDITIONAL REQUIREMENTS.

No additional requirements exist except as provided in other sections of this permit including Section B (Title V General Requirements) and/or Section E (Source Group Restrictions).

***** Permit Shield in Effect. *****

**SECTION D. Source Level Requirements**

Source ID: 203

Source Name: LEAD OXIDE MILL 15

Source Capacity/Throughput: 2,600.000 Lbs/HR
750.000 CF/HRLEAD OXIDE
Natural Gas

Conditions for this source occur in the following groups: SG 05 OXIDE PLANT

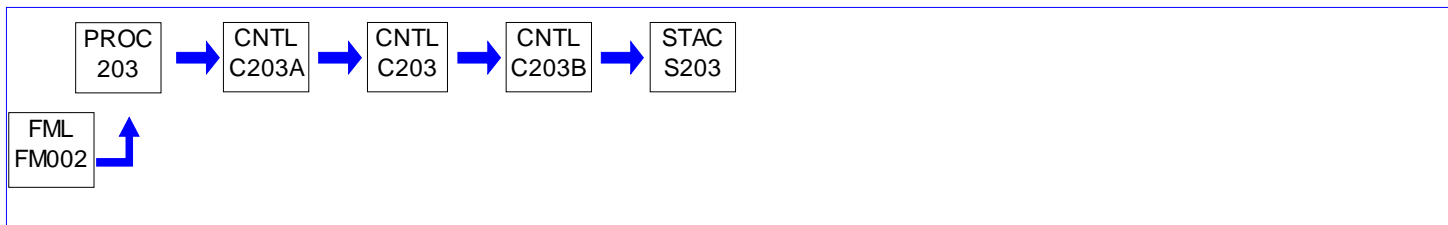
**I. RESTRICTIONS.**

No additional requirements exist except as provided in other sections of this permit including Section B (Title V General Requirements) and/or Section E (Source Group Restrictions).

II. TESTING REQUIREMENTS.

No additional testing requirements exist except as provided in other sections of this permit including Section B (Title V General Requirements) and/or Section E (Source Group Restrictions).

III. MONITORING REQUIREMENTS.

No additional monitoring requirements exist except as provided in other sections of this permit including Section B (Title V General Requirements) and/or Section E (Source Group Restrictions).

IV. RECORDKEEPING REQUIREMENTS.

No additional record keeping requirements exist except as provided in other sections of this permit including Section B (Title V General Requirements) and/or Section E (Source Group Restrictions).

V. REPORTING REQUIREMENTS.

No additional reporting requirements exist except as provided in other sections of this permit including Section B (Title V General Requirements) and/or Section E (Source Group Restrictions).

VI. WORK PRACTICE REQUIREMENTS.

No additional work practice requirements exist except as provided in other sections of this permit including Section B (Title V General Requirements) and/or Section E (Source Group Restrictions).

VII. ADDITIONAL REQUIREMENTS.

No additional requirements exist except as provided in other sections of this permit including Section B (Title V General Requirements) and/or Section E (Source Group Restrictions).

***** Permit Shield in Effect. *****

**SECTION D. Source Level Requirements**

Source ID: 204

Source Name: LEAD OXIDE MILL 16

Source Capacity/Throughput: 2,600.000 Lbs/HR
750.000 CF/HRLEAD OXIDE
Natural Gas

Conditions for this source occur in the following groups: SG 05 OXIDE PLANT

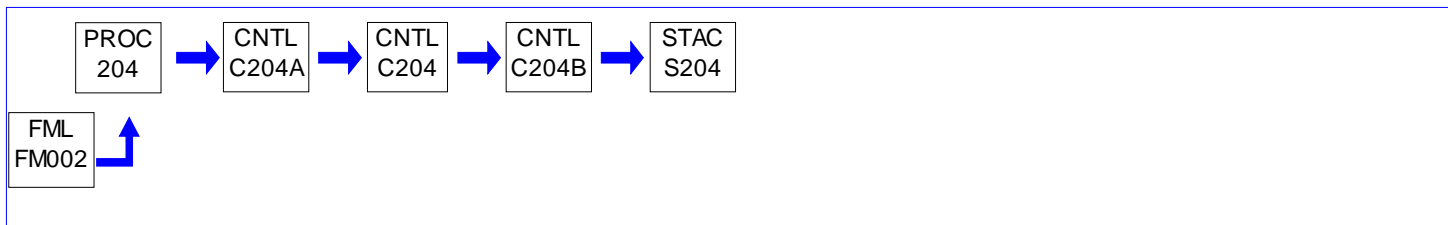
**I. RESTRICTIONS.**

No additional requirements exist except as provided in other sections of this permit including Section B (Title V General Requirements) and/or Section E (Source Group Restrictions).

II. TESTING REQUIREMENTS.

No additional testing requirements exist except as provided in other sections of this permit including Section B (Title V General Requirements) and/or Section E (Source Group Restrictions).

III. MONITORING REQUIREMENTS.

No additional monitoring requirements exist except as provided in other sections of this permit including Section B (Title V General Requirements) and/or Section E (Source Group Restrictions).

IV. RECORDKEEPING REQUIREMENTS.

No additional record keeping requirements exist except as provided in other sections of this permit including Section B (Title V General Requirements) and/or Section E (Source Group Restrictions).

V. REPORTING REQUIREMENTS.

No additional reporting requirements exist except as provided in other sections of this permit including Section B (Title V General Requirements) and/or Section E (Source Group Restrictions).

VI. WORK PRACTICE REQUIREMENTS.

No additional work practice requirements exist except as provided in other sections of this permit including Section B (Title V General Requirements) and/or Section E (Source Group Restrictions).

VII. ADDITIONAL REQUIREMENTS.

No additional requirements exist except as provided in other sections of this permit including Section B (Title V General Requirements) and/or Section E (Source Group Restrictions).

***** Permit Shield in Effect. *****

**SECTION D. Source Level Requirements**

Source ID: 205

Source Name: LEAD OXIDE MILL 17

Source Capacity/Throughput: 2,600.000 Lbs/HR
750.000 CF/HRLEAD OXIDE
Natural Gas

Conditions for this source occur in the following groups: SG 05 OXIDE PLANT

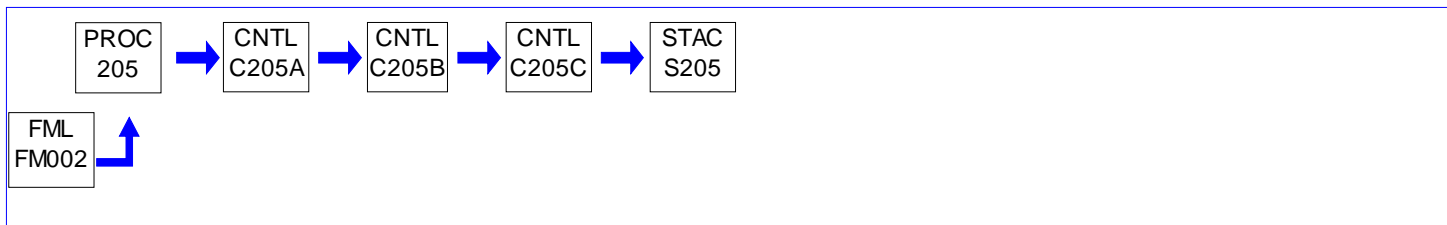
**I. RESTRICTIONS.**

No additional requirements exist except as provided in other sections of this permit including Section B (Title V General Requirements) and/or Section E (Source Group Restrictions).

II. TESTING REQUIREMENTS.

No additional testing requirements exist except as provided in other sections of this permit including Section B (Title V General Requirements) and/or Section E (Source Group Restrictions).

III. MONITORING REQUIREMENTS.

No additional monitoring requirements exist except as provided in other sections of this permit including Section B (Title V General Requirements) and/or Section E (Source Group Restrictions).

IV. RECORDKEEPING REQUIREMENTS.

No additional record keeping requirements exist except as provided in other sections of this permit including Section B (Title V General Requirements) and/or Section E (Source Group Restrictions).

V. REPORTING REQUIREMENTS.

No additional reporting requirements exist except as provided in other sections of this permit including Section B (Title V General Requirements) and/or Section E (Source Group Restrictions).

VI. WORK PRACTICE REQUIREMENTS.

No additional work practice requirements exist except as provided in other sections of this permit including Section B (Title V General Requirements) and/or Section E (Source Group Restrictions).

VII. ADDITIONAL REQUIREMENTS.

No additional requirements exist except as provided in other sections of this permit including Section B (Title V General Requirements) and/or Section E (Source Group Restrictions).

***** Permit Shield in Effect. *****

**SECTION D. Source Level Requirements**

Source ID: 206

Source Name: LEAD OXIDE MILL 18

Source Capacity/Throughput:	2,600.000 Lbs/HR	LEAD OXIDE
	750.000 CF/HR	Natural Gas

Conditions for this source occur in the following groups: SG 05 OXIDE PLANT

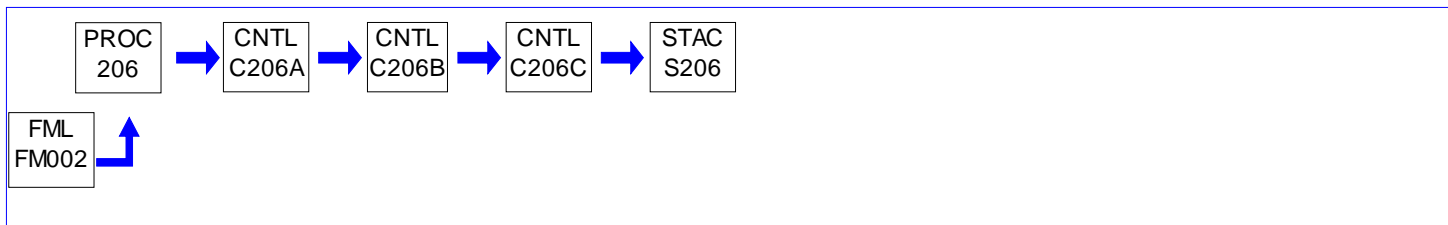
**I. RESTRICTIONS.**

No additional requirements exist except as provided in other sections of this permit including Section B (Title V General Requirements) and/or Section E (Source Group Restrictions).

II. TESTING REQUIREMENTS.

No additional testing requirements exist except as provided in other sections of this permit including Section B (Title V General Requirements) and/or Section E (Source Group Restrictions).

III. MONITORING REQUIREMENTS.

No additional monitoring requirements exist except as provided in other sections of this permit including Section B (Title V General Requirements) and/or Section E (Source Group Restrictions).

IV. RECORDKEEPING REQUIREMENTS.

No additional record keeping requirements exist except as provided in other sections of this permit including Section B (Title V General Requirements) and/or Section E (Source Group Restrictions).

V. REPORTING REQUIREMENTS.

No additional reporting requirements exist except as provided in other sections of this permit including Section B (Title V General Requirements) and/or Section E (Source Group Restrictions).

VI. WORK PRACTICE REQUIREMENTS.

No additional work practice requirements exist except as provided in other sections of this permit including Section B (Title V General Requirements) and/or Section E (Source Group Restrictions).

VII. ADDITIONAL REQUIREMENTS.

No additional requirements exist except as provided in other sections of this permit including Section B (Title V General Requirements) and/or Section E (Source Group Restrictions).

***** Permit Shield in Effect. *****

**SECTION D. Source Level Requirements**

Source ID: 207

Source Name: LEAD OXIDE MILL 19

Source Capacity/Throughput: 2,600.000 Lbs/HR
750.000 CF/HRLEAD OXIDE
Natural Gas

Conditions for this source occur in the following groups: SG 05 OXIDE PLANT

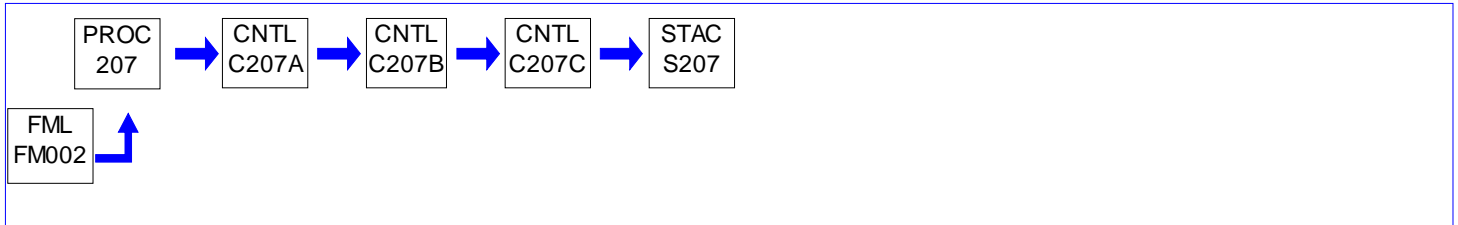
**I. RESTRICTIONS.**

No additional requirements exist except as provided in other sections of this permit including Section B (Title V General Requirements) and/or Section E (Source Group Restrictions).

II. TESTING REQUIREMENTS.

No additional testing requirements exist except as provided in other sections of this permit including Section B (Title V General Requirements) and/or Section E (Source Group Restrictions).

III. MONITORING REQUIREMENTS.

No additional monitoring requirements exist except as provided in other sections of this permit including Section B (Title V General Requirements) and/or Section E (Source Group Restrictions).

IV. RECORDKEEPING REQUIREMENTS.

No additional record keeping requirements exist except as provided in other sections of this permit including Section B (Title V General Requirements) and/or Section E (Source Group Restrictions).

V. REPORTING REQUIREMENTS.

No additional reporting requirements exist except as provided in other sections of this permit including Section B (Title V General Requirements) and/or Section E (Source Group Restrictions).

VI. WORK PRACTICE REQUIREMENTS.

No additional work practice requirements exist except as provided in other sections of this permit including Section B (Title V General Requirements) and/or Section E (Source Group Restrictions).

VII. ADDITIONAL REQUIREMENTS.

No additional requirements exist except as provided in other sections of this permit including Section B (Title V General Requirements) and/or Section E (Source Group Restrictions).

***** Permit Shield in Effect. *****

**SECTION D. Source Level Requirements**

Source ID: 208

Source Name: LEAD OXIDE MILL 20

Source Capacity/Throughput:	2,600.000 Lbs/HR	LEAD OXIDE
	750.000 CF/HR	Natural Gas

Conditions for this source occur in the following groups: SG 05 OXIDE PLANT

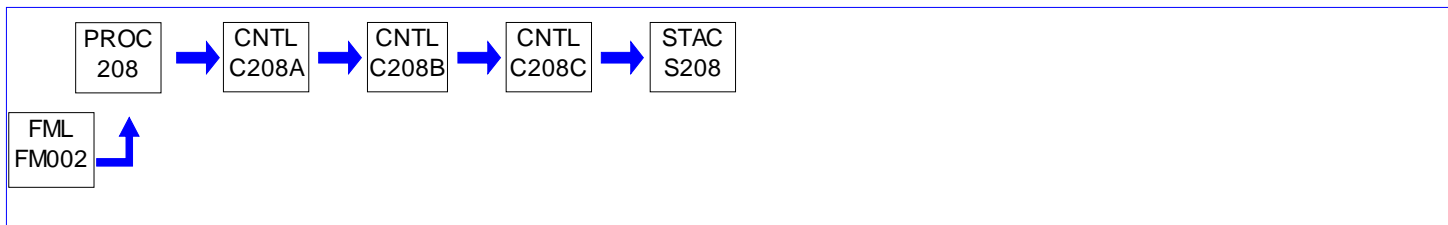
**I. RESTRICTIONS.**

No additional requirements exist except as provided in other sections of this permit including Section B (Title V General Requirements) and/or Section E (Source Group Restrictions).

II. TESTING REQUIREMENTS.

No additional testing requirements exist except as provided in other sections of this permit including Section B (Title V General Requirements) and/or Section E (Source Group Restrictions).

III. MONITORING REQUIREMENTS.

No additional monitoring requirements exist except as provided in other sections of this permit including Section B (Title V General Requirements) and/or Section E (Source Group Restrictions).

IV. RECORDKEEPING REQUIREMENTS.

No additional record keeping requirements exist except as provided in other sections of this permit including Section B (Title V General Requirements) and/or Section E (Source Group Restrictions).

V. REPORTING REQUIREMENTS.

No additional reporting requirements exist except as provided in other sections of this permit including Section B (Title V General Requirements) and/or Section E (Source Group Restrictions).

VI. WORK PRACTICE REQUIREMENTS.

No additional work practice requirements exist except as provided in other sections of this permit including Section B (Title V General Requirements) and/or Section E (Source Group Restrictions).

VII. ADDITIONAL REQUIREMENTS.

No additional requirements exist except as provided in other sections of this permit including Section B (Title V General Requirements) and/or Section E (Source Group Restrictions).

***** Permit Shield in Effect. *****

**SECTION D. Source Level Requirements**

Source ID: 210

Source Name: WTP SALT DRYER

Source Capacity/Throughput: 0.961 MMBTU/HR

961.000 CF/HR

Natural Gas

1,953.000 Lbs/HR

SALT (WET)

Conditions for this source occur in the following groups: SG 07 WASTE WATER TP
SG12 BAGHOUSE CAM

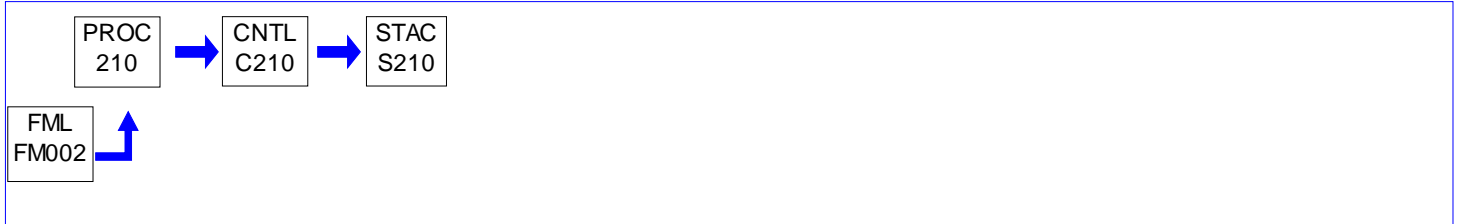
**I. RESTRICTIONS.**

No additional requirements exist except as provided in other sections of this permit including Section B (Title V General Requirements) and/or Section E (Source Group Restrictions).

II. TESTING REQUIREMENTS.

No additional testing requirements exist except as provided in other sections of this permit including Section B (Title V General Requirements) and/or Section E (Source Group Restrictions).

III. MONITORING REQUIREMENTS.

No additional monitoring requirements exist except as provided in other sections of this permit including Section B (Title V General Requirements) and/or Section E (Source Group Restrictions).

IV. RECORDKEEPING REQUIREMENTS.

No additional record keeping requirements exist except as provided in other sections of this permit including Section B (Title V General Requirements) and/or Section E (Source Group Restrictions).

V. REPORTING REQUIREMENTS.

No additional reporting requirements exist except as provided in other sections of this permit including Section B (Title V General Requirements) and/or Section E (Source Group Restrictions).

VI. WORK PRACTICE REQUIREMENTS.

No additional work practice requirements exist except as provided in other sections of this permit including Section B (Title V General Requirements) and/or Section E (Source Group Restrictions).

VII. ADDITIONAL REQUIREMENTS.

No additional requirements exist except as provided in other sections of this permit including Section B (Title V General Requirements) and/or Section E (Source Group Restrictions).

***** Permit Shield in Effect. *****

**SECTION D. Source Level Requirements**

Source ID: 211

Source Name: WTP SALT TRUCK LOADOUT OPERATION

Source Capacity/Throughput: 1,953.000 Lbs/HR SALT (WET)

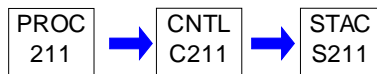
Conditions for this source occur in the following groups: SG 07 WASTE WATER TP
SG12 BAGHOUSE CAM**I. RESTRICTIONS.**

No additional requirements exist except as provided in other sections of this permit including Section B (Title V General Requirements) and/or Section E (Source Group Restrictions).

II. TESTING REQUIREMENTS.

No additional testing requirements exist except as provided in other sections of this permit including Section B (Title V General Requirements) and/or Section E (Source Group Restrictions).

III. MONITORING REQUIREMENTS.

No additional monitoring requirements exist except as provided in other sections of this permit including Section B (Title V General Requirements) and/or Section E (Source Group Restrictions).

IV. RECORDKEEPING REQUIREMENTS.

No additional record keeping requirements exist except as provided in other sections of this permit including Section B (Title V General Requirements) and/or Section E (Source Group Restrictions).

V. REPORTING REQUIREMENTS.

No additional reporting requirements exist except as provided in other sections of this permit including Section B (Title V General Requirements) and/or Section E (Source Group Restrictions).

VI. WORK PRACTICE REQUIREMENTS.

No additional work practice requirements exist except as provided in other sections of this permit including Section B (Title V General Requirements) and/or Section E (Source Group Restrictions).

VII. ADDITIONAL REQUIREMENTS.

No additional requirements exist except as provided in other sections of this permit including Section B (Title V General Requirements) and/or Section E (Source Group Restrictions).

***** Permit Shield in Effect. *****

**SECTION D. Source Level Requirements**

Source ID: 212

Source Name: WTP SALT STORAGE SILOS

Source Capacity/Throughput: 30,000.000 Lbs/HR SALT (DRY)

Conditions for this source occur in the following groups: SG 07 WASTE WATER TP

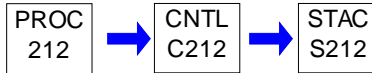
**I. RESTRICTIONS.**

No additional requirements exist except as provided in other sections of this permit including Section B (Title V General Requirements) and/or Section E (Source Group Restrictions).

II. TESTING REQUIREMENTS.

No additional testing requirements exist except as provided in other sections of this permit including Section B (Title V General Requirements) and/or Section E (Source Group Restrictions).

III. MONITORING REQUIREMENTS.

No additional monitoring requirements exist except as provided in other sections of this permit including Section B (Title V General Requirements) and/or Section E (Source Group Restrictions).

IV. RECORDKEEPING REQUIREMENTS.

No additional record keeping requirements exist except as provided in other sections of this permit including Section B (Title V General Requirements) and/or Section E (Source Group Restrictions).

V. REPORTING REQUIREMENTS.

No additional reporting requirements exist except as provided in other sections of this permit including Section B (Title V General Requirements) and/or Section E (Source Group Restrictions).

VI. WORK PRACTICE REQUIREMENTS.

No additional work practice requirements exist except as provided in other sections of this permit including Section B (Title V General Requirements) and/or Section E (Source Group Restrictions).

VII. ADDITIONAL REQUIREMENTS.

No additional requirements exist except as provided in other sections of this permit including Section B (Title V General Requirements) and/or Section E (Source Group Restrictions).

***** Permit Shield in Effect. *****

**SECTION D. Source Level Requirements**

Source ID: 213

Source Name: MISCELLANEOUS CHEM

Source Capacity/Throughput:

Conditions for this source occur in the following groups: SG10C RACT 2
SG21 RACT III CBC

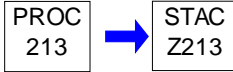
**I. RESTRICTIONS.**

No additional requirements exist except as provided in other sections of this permit including Section B (Title V General Requirements) and/or Section E (Source Group Restrictions).

II. TESTING REQUIREMENTS.

No additional testing requirements exist except as provided in other sections of this permit including Section B (Title V General Requirements) and/or Section E (Source Group Restrictions).

III. MONITORING REQUIREMENTS.

No additional monitoring requirements exist except as provided in other sections of this permit including Section B (Title V General Requirements) and/or Section E (Source Group Restrictions).

IV. RECORDKEEPING REQUIREMENTS.

No additional record keeping requirements exist except as provided in other sections of this permit including Section B (Title V General Requirements) and/or Section E (Source Group Restrictions).

V. REPORTING REQUIREMENTS.

No additional reporting requirements exist except as provided in other sections of this permit including Section B (Title V General Requirements) and/or Section E (Source Group Restrictions).

VI. WORK PRACTICE REQUIREMENTS.

No additional work practice requirements exist except as provided in other sections of this permit including Section B (Title V General Requirements) and/or Section E (Source Group Restrictions).

VII. ADDITIONAL REQUIREMENTS.

No additional requirements exist except as provided in other sections of this permit including Section B (Title V General Requirements) and/or Section E (Source Group Restrictions).

***** Permit Shield in Effect. *****

**SECTION D. Source Level Requirements**

Source ID: 214

Source Name: SPRAY BOOTH- CENTRAL MAINT PAINT BOOTH

Source Capacity/Throughput:

Conditions for this source occur in the following groups: SG10B RACT 2
SG20 RACT III PRESUMPTIVE

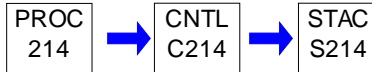
**I. RESTRICTIONS.****Emission Restriction(s).****# 001 [25 Pa. Code §123.13]****Processes**

The permittee shall not permit the emission to the atmosphere of particulate matter from either source in a manner that the concentration of particulate matter in the effluent gas exceeds 0.04 grain per dry standard cubic foot.

II. TESTING REQUIREMENTS.

No additional testing requirements exist except as provided in other sections of this permit including Section B (Title V General Requirements) and/or Section E (Source Group Restrictions).

III. MONITORING REQUIREMENTS.

No additional monitoring requirements exist except as provided in other sections of this permit including Section B (Title V General Requirements) and/or Section E (Source Group Restrictions).

IV. RECORDKEEPING REQUIREMENTS.**# 002 [25 Pa. Code §127.441]****Operating permit terms and conditions.**

The permittee shall record the following information for waste coatings, solvents or mixtures sent off-site for recycling or disposal:

- Pounds and gallons per month of waste coating, solvents or mixtures shipped from the facility,
- Waste profile or sampling data for each shipment, and
- Identification of the waste disposal company for each shipment.

V. REPORTING REQUIREMENTS.

No additional reporting requirements exist except as provided in other sections of this permit including Section B (Title V General Requirements) and/or Section E (Source Group Restrictions).

VI. WORK PRACTICE REQUIREMENTS.

No additional work practice requirements exist except as provided in other sections of this permit including Section B (Title V General Requirements) and/or Section E (Source Group Restrictions).

VII. ADDITIONAL REQUIREMENTS.

No additional requirements exist except as provided in other sections of this permit including Section B (Title V General Requirements) and/or Section E (Source Group Restrictions).



SECTION D. Source Level Requirements

***** Permit Shield in Effect. *****

**SECTION D. Source Level Requirements**

Source ID: 221

Source Name: LEAD OXIDE MILL NO. 21

Source Capacity/Throughput: 2,600.000 Lbs/HR
750.000 CF/HRLEAD OXIDE
Natural Gas

Conditions for this source occur in the following groups: SG 05 OXIDE PLANT

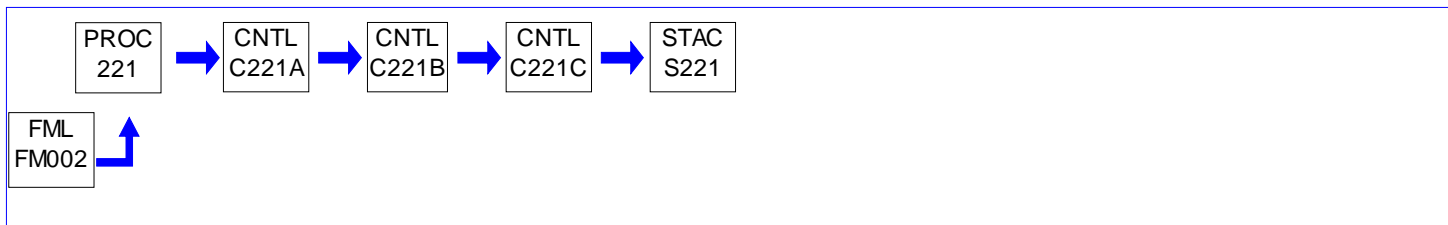
**I. RESTRICTIONS.**

No additional requirements exist except as provided in other sections of this permit including Section B (Title V General Requirements) and/or Section E (Source Group Restrictions).

II. TESTING REQUIREMENTS.

No additional testing requirements exist except as provided in other sections of this permit including Section B (Title V General Requirements) and/or Section E (Source Group Restrictions).

III. MONITORING REQUIREMENTS.

No additional monitoring requirements exist except as provided in other sections of this permit including Section B (Title V General Requirements) and/or Section E (Source Group Restrictions).

IV. RECORDKEEPING REQUIREMENTS.

No additional record keeping requirements exist except as provided in other sections of this permit including Section B (Title V General Requirements) and/or Section E (Source Group Restrictions).

V. REPORTING REQUIREMENTS.

No additional reporting requirements exist except as provided in other sections of this permit including Section B (Title V General Requirements) and/or Section E (Source Group Restrictions).

VI. WORK PRACTICE REQUIREMENTS.

No additional work practice requirements exist except as provided in other sections of this permit including Section B (Title V General Requirements) and/or Section E (Source Group Restrictions).

VII. ADDITIONAL REQUIREMENTS.

No additional requirements exist except as provided in other sections of this permit including Section B (Title V General Requirements) and/or Section E (Source Group Restrictions).

***** Permit Shield in Effect. *****

**SECTION D. Source Level Requirements**

Source ID: 222

Source Name: LEAD OXIDE MILL NO. 22

Source Capacity/Throughput: 2,600.000 Lbs/HR
750.000 CF/HRLEAD OXIDE
Natural Gas

Conditions for this source occur in the following groups: SG 05 OXIDE PLANT

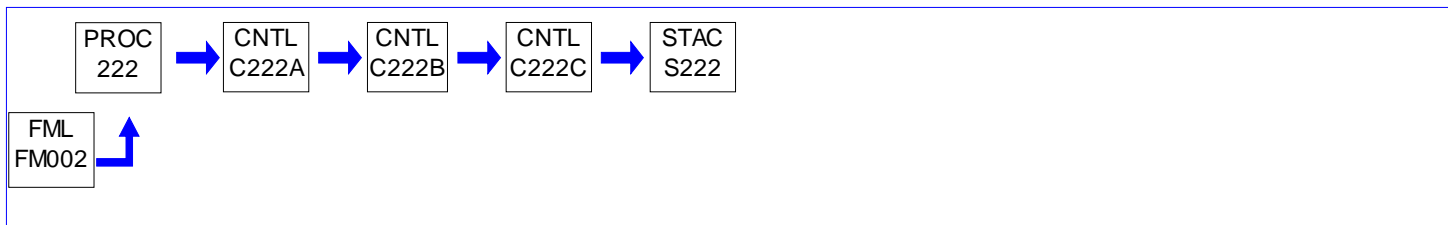
**I. RESTRICTIONS.**

No additional requirements exist except as provided in other sections of this permit including Section B (Title V General Requirements) and/or Section E (Source Group Restrictions).

II. TESTING REQUIREMENTS.

No additional testing requirements exist except as provided in other sections of this permit including Section B (Title V General Requirements) and/or Section E (Source Group Restrictions).

III. MONITORING REQUIREMENTS.

No additional monitoring requirements exist except as provided in other sections of this permit including Section B (Title V General Requirements) and/or Section E (Source Group Restrictions).

IV. RECORDKEEPING REQUIREMENTS.

No additional record keeping requirements exist except as provided in other sections of this permit including Section B (Title V General Requirements) and/or Section E (Source Group Restrictions).

V. REPORTING REQUIREMENTS.

No additional reporting requirements exist except as provided in other sections of this permit including Section B (Title V General Requirements) and/or Section E (Source Group Restrictions).

VI. WORK PRACTICE REQUIREMENTS.

No additional work practice requirements exist except as provided in other sections of this permit including Section B (Title V General Requirements) and/or Section E (Source Group Restrictions).

VII. ADDITIONAL REQUIREMENTS.

No additional requirements exist except as provided in other sections of this permit including Section B (Title V General Requirements) and/or Section E (Source Group Restrictions).

***** Permit Shield in Effect. *****

**SECTION D. Source Level Requirements**

Source ID: 223

Source Name: LEAD OXIDE MILL NO. 23

Source Capacity/Throughput: 2,600.000 Lbs/HR
750.000 CF/HRLEAD OXIDE
Natural Gas

Conditions for this source occur in the following groups: SG 05 OXIDE PLANT

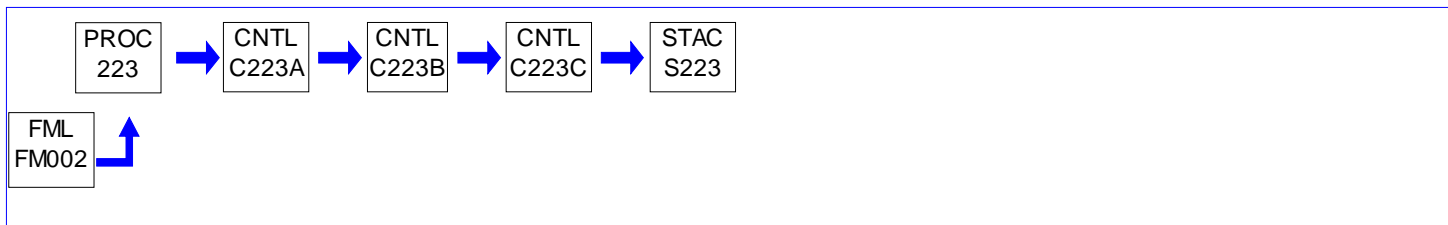
**I. RESTRICTIONS.**

No additional requirements exist except as provided in other sections of this permit including Section B (Title V General Requirements) and/or Section E (Source Group Restrictions).

II. TESTING REQUIREMENTS.

No additional testing requirements exist except as provided in other sections of this permit including Section B (Title V General Requirements) and/or Section E (Source Group Restrictions).

III. MONITORING REQUIREMENTS.

No additional monitoring requirements exist except as provided in other sections of this permit including Section B (Title V General Requirements) and/or Section E (Source Group Restrictions).

IV. RECORDKEEPING REQUIREMENTS.

No additional record keeping requirements exist except as provided in other sections of this permit including Section B (Title V General Requirements) and/or Section E (Source Group Restrictions).

V. REPORTING REQUIREMENTS.

No additional reporting requirements exist except as provided in other sections of this permit including Section B (Title V General Requirements) and/or Section E (Source Group Restrictions).

VI. WORK PRACTICE REQUIREMENTS.

No additional work practice requirements exist except as provided in other sections of this permit including Section B (Title V General Requirements) and/or Section E (Source Group Restrictions).

VII. ADDITIONAL REQUIREMENTS.

No additional requirements exist except as provided in other sections of this permit including Section B (Title V General Requirements) and/or Section E (Source Group Restrictions).

***** Permit Shield in Effect. *****

**SECTION D. Source Level Requirements**

Source ID: 224

Source Name: LEAD OXIDE MILL NO. 24

Source Capacity/Throughput: 2,600.000 Lbs/HR
750.000 CF/HRLEAD OXIDE
Natural Gas

Conditions for this source occur in the following groups: SG 05 OXIDE PLANT

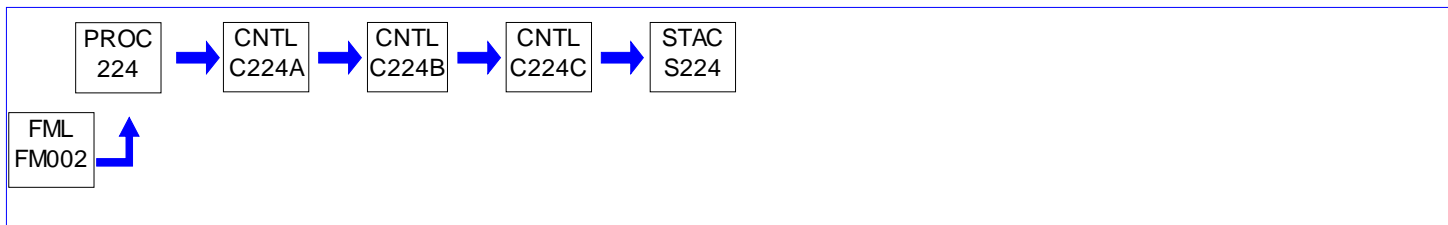
**I. RESTRICTIONS.**

No additional requirements exist except as provided in other sections of this permit including Section B (Title V General Requirements) and/or Section E (Source Group Restrictions).

II. TESTING REQUIREMENTS.

No additional testing requirements exist except as provided in other sections of this permit including Section B (Title V General Requirements) and/or Section E (Source Group Restrictions).

III. MONITORING REQUIREMENTS.

No additional monitoring requirements exist except as provided in other sections of this permit including Section B (Title V General Requirements) and/or Section E (Source Group Restrictions).

IV. RECORDKEEPING REQUIREMENTS.

No additional record keeping requirements exist except as provided in other sections of this permit including Section B (Title V General Requirements) and/or Section E (Source Group Restrictions).

V. REPORTING REQUIREMENTS.

No additional reporting requirements exist except as provided in other sections of this permit including Section B (Title V General Requirements) and/or Section E (Source Group Restrictions).

VI. WORK PRACTICE REQUIREMENTS.

No additional work practice requirements exist except as provided in other sections of this permit including Section B (Title V General Requirements) and/or Section E (Source Group Restrictions).

VII. ADDITIONAL REQUIREMENTS.

No additional requirements exist except as provided in other sections of this permit including Section B (Title V General Requirements) and/or Section E (Source Group Restrictions).

***** Permit Shield in Effect. *****

**SECTION D. Source Level Requirements**

Source ID: 225

Source Name: LEAD OXIDE MILL NO. 25

Source Capacity/Throughput: 2,600.000 Lbs/HR
750.000 CF/HRLEAD OXIDE
Natural Gas

Conditions for this source occur in the following groups: SG 05 OXIDE PLANT

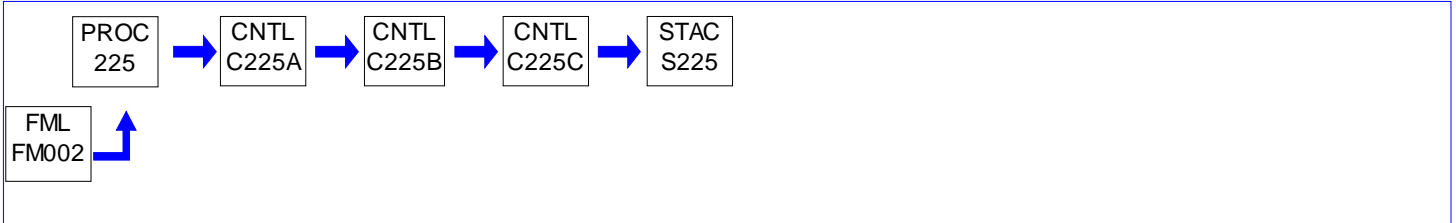
**I. RESTRICTIONS.**

No additional requirements exist except as provided in other sections of this permit including Section B (Title V General Requirements) and/or Section E (Source Group Restrictions).

II. TESTING REQUIREMENTS.

No additional testing requirements exist except as provided in other sections of this permit including Section B (Title V General Requirements) and/or Section E (Source Group Restrictions).

III. MONITORING REQUIREMENTS.

No additional monitoring requirements exist except as provided in other sections of this permit including Section B (Title V General Requirements) and/or Section E (Source Group Restrictions).

IV. RECORDKEEPING REQUIREMENTS.

No additional record keeping requirements exist except as provided in other sections of this permit including Section B (Title V General Requirements) and/or Section E (Source Group Restrictions).

V. REPORTING REQUIREMENTS.

No additional reporting requirements exist except as provided in other sections of this permit including Section B (Title V General Requirements) and/or Section E (Source Group Restrictions).

VI. WORK PRACTICE REQUIREMENTS.

No additional work practice requirements exist except as provided in other sections of this permit including Section B (Title V General Requirements) and/or Section E (Source Group Restrictions).

VII. ADDITIONAL REQUIREMENTS.

No additional requirements exist except as provided in other sections of this permit including Section B (Title V General Requirements) and/or Section E (Source Group Restrictions).

***** Permit Shield in Effect. *****

**SECTION D. Source Level Requirements**

Source ID: 226

Source Name: LEAD OXIDE MILL NO. 26

Source Capacity/Throughput: 2,600.000 Lbs/HR
750.000 CF/HRLEAD OXIDE
Natural Gas

Conditions for this source occur in the following groups: SG 05 OXIDE PLANT

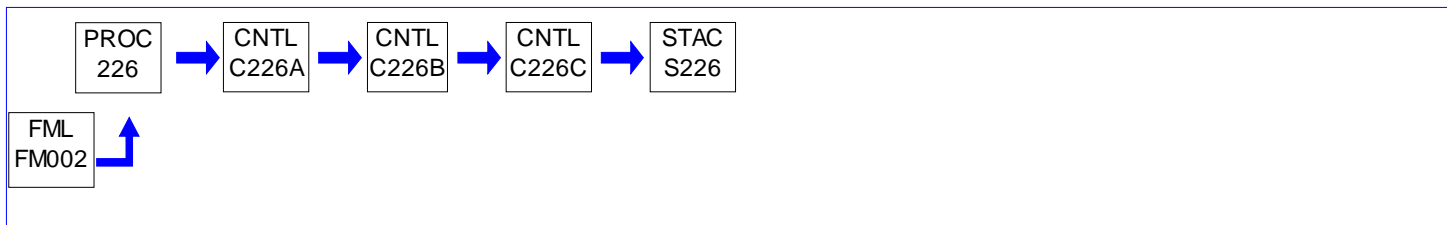
**I. RESTRICTIONS.**

No additional requirements exist except as provided in other sections of this permit including Section B (Title V General Requirements) and/or Section E (Source Group Restrictions).

II. TESTING REQUIREMENTS.

No additional testing requirements exist except as provided in other sections of this permit including Section B (Title V General Requirements) and/or Section E (Source Group Restrictions).

III. MONITORING REQUIREMENTS.

No additional monitoring requirements exist except as provided in other sections of this permit including Section B (Title V General Requirements) and/or Section E (Source Group Restrictions).

IV. RECORDKEEPING REQUIREMENTS.

No additional record keeping requirements exist except as provided in other sections of this permit including Section B (Title V General Requirements) and/or Section E (Source Group Restrictions).

V. REPORTING REQUIREMENTS.

No additional reporting requirements exist except as provided in other sections of this permit including Section B (Title V General Requirements) and/or Section E (Source Group Restrictions).

VI. WORK PRACTICE REQUIREMENTS.

No additional work practice requirements exist except as provided in other sections of this permit including Section B (Title V General Requirements) and/or Section E (Source Group Restrictions).

VII. ADDITIONAL REQUIREMENTS.

No additional requirements exist except as provided in other sections of this permit including Section B (Title V General Requirements) and/or Section E (Source Group Restrictions).

***** Permit Shield in Effect. *****

**SECTION D. Source Level Requirements**

Source ID: 227

Source Name: LEAD OXIDE MILL NO. 27

Source Capacity/Throughput: 2,600.000 Lbs/HR
750.000 CF/HRLEAD OXIDE
Natural Gas

Conditions for this source occur in the following groups: SG 05 OXIDE PLANT

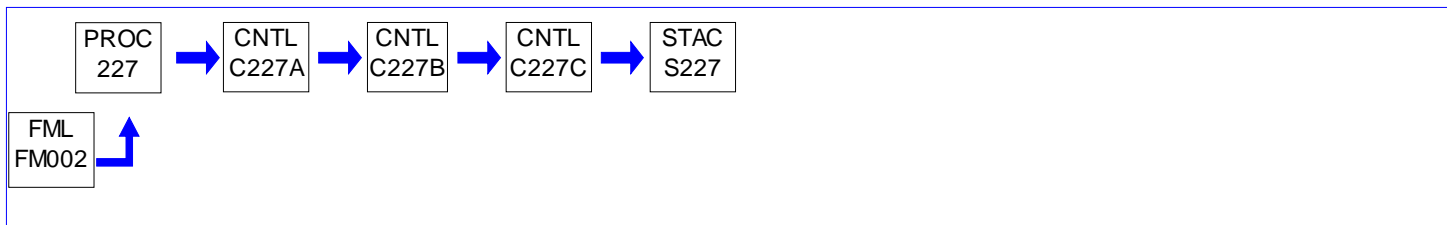
**I. RESTRICTIONS.**

No additional requirements exist except as provided in other sections of this permit including Section B (Title V General Requirements) and/or Section E (Source Group Restrictions).

II. TESTING REQUIREMENTS.

No additional testing requirements exist except as provided in other sections of this permit including Section B (Title V General Requirements) and/or Section E (Source Group Restrictions).

III. MONITORING REQUIREMENTS.

No additional monitoring requirements exist except as provided in other sections of this permit including Section B (Title V General Requirements) and/or Section E (Source Group Restrictions).

IV. RECORDKEEPING REQUIREMENTS.

No additional record keeping requirements exist except as provided in other sections of this permit including Section B (Title V General Requirements) and/or Section E (Source Group Restrictions).

V. REPORTING REQUIREMENTS.

No additional reporting requirements exist except as provided in other sections of this permit including Section B (Title V General Requirements) and/or Section E (Source Group Restrictions).

VI. WORK PRACTICE REQUIREMENTS.

No additional work practice requirements exist except as provided in other sections of this permit including Section B (Title V General Requirements) and/or Section E (Source Group Restrictions).

VII. ADDITIONAL REQUIREMENTS.

No additional requirements exist except as provided in other sections of this permit including Section B (Title V General Requirements) and/or Section E (Source Group Restrictions).

***** Permit Shield in Effect. *****

**SECTION D. Source Level Requirements**

Source ID: 228

Source Name: LEAD OXIDE MILL NO. 28

Source Capacity/Throughput:	2,600.000 Lbs/HR	LEAD OXIDE
	750.000 CF/HR	Natural Gas

Conditions for this source occur in the following groups: SG 05 OXIDE PLANT

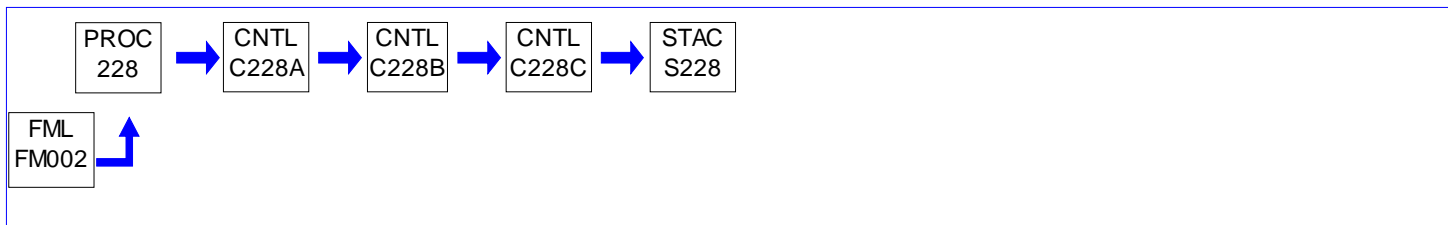
**I. RESTRICTIONS.**

No additional requirements exist except as provided in other sections of this permit including Section B (Title V General Requirements) and/or Section E (Source Group Restrictions).

II. TESTING REQUIREMENTS.

No additional testing requirements exist except as provided in other sections of this permit including Section B (Title V General Requirements) and/or Section E (Source Group Restrictions).

III. MONITORING REQUIREMENTS.

No additional monitoring requirements exist except as provided in other sections of this permit including Section B (Title V General Requirements) and/or Section E (Source Group Restrictions).

IV. RECORDKEEPING REQUIREMENTS.

No additional record keeping requirements exist except as provided in other sections of this permit including Section B (Title V General Requirements) and/or Section E (Source Group Restrictions).

V. REPORTING REQUIREMENTS.

No additional reporting requirements exist except as provided in other sections of this permit including Section B (Title V General Requirements) and/or Section E (Source Group Restrictions).

VI. WORK PRACTICE REQUIREMENTS.

No additional work practice requirements exist except as provided in other sections of this permit including Section B (Title V General Requirements) and/or Section E (Source Group Restrictions).

VII. ADDITIONAL REQUIREMENTS.

No additional requirements exist except as provided in other sections of this permit including Section B (Title V General Requirements) and/or Section E (Source Group Restrictions).

***** Permit Shield in Effect. *****

**SECTION D. Source Level Requirements**

Source ID: 229

Source Name: LEAD OXIDE MILL NO. 29

Source Capacity/Throughput: 0.750 MMBTU/HR

Conditions for this source occur in the following groups: SG 05 OXIDE PLANT

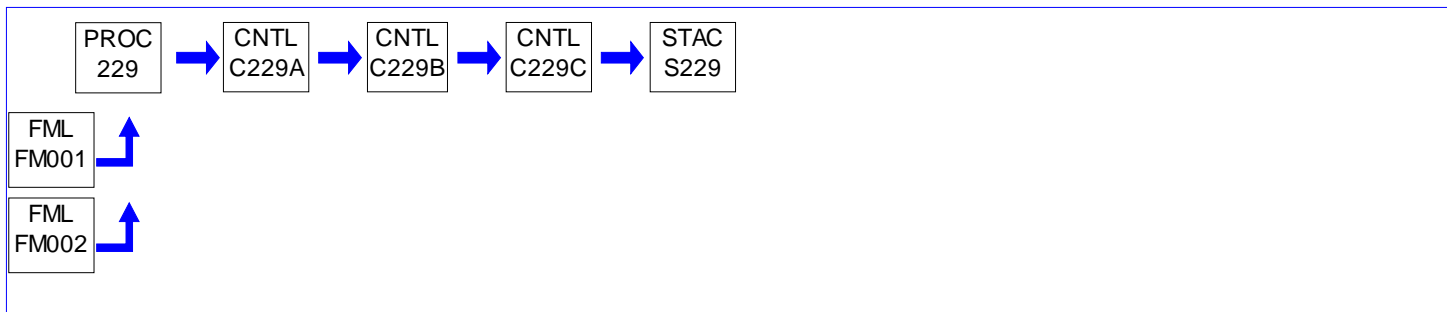
**I. RESTRICTIONS.**

No additional requirements exist except as provided in other sections of this permit including Section B (Title V General Requirements) and/or Section E (Source Group Restrictions).

II. TESTING REQUIREMENTS.

No additional testing requirements exist except as provided in other sections of this permit including Section B (Title V General Requirements) and/or Section E (Source Group Restrictions).

III. MONITORING REQUIREMENTS.

No additional monitoring requirements exist except as provided in other sections of this permit including Section B (Title V General Requirements) and/or Section E (Source Group Restrictions).

IV. RECORDKEEPING REQUIREMENTS.

No additional record keeping requirements exist except as provided in other sections of this permit including Section B (Title V General Requirements) and/or Section E (Source Group Restrictions).

V. REPORTING REQUIREMENTS.

No additional reporting requirements exist except as provided in other sections of this permit including Section B (Title V General Requirements) and/or Section E (Source Group Restrictions).

VI. WORK PRACTICE REQUIREMENTS.

No additional work practice requirements exist except as provided in other sections of this permit including Section B (Title V General Requirements) and/or Section E (Source Group Restrictions).

VII. ADDITIONAL REQUIREMENTS.

No additional requirements exist except as provided in other sections of this permit including Section B (Title V General Requirements) and/or Section E (Source Group Restrictions).

***** Permit Shield in Effect. *****

**SECTION D. Source Level Requirements**

Source ID: 230

Source Name: LEAD OXIDE MILL NO. 30

Source Capacity/Throughput: 0.750 MMBTU/HR

Conditions for this source occur in the following groups: SG 05 OXIDE PLANT

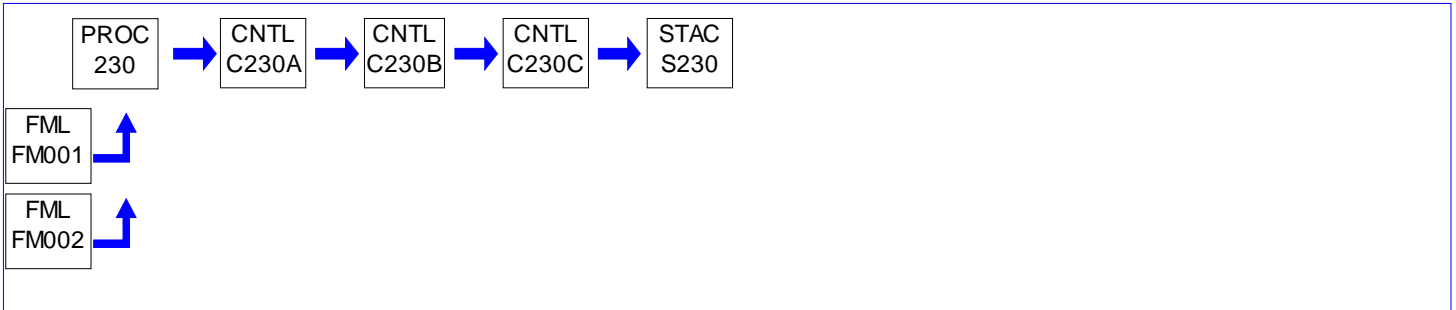
**I. RESTRICTIONS.**

No additional requirements exist except as provided in other sections of this permit including Section B (Title V General Requirements) and/or Section E (Source Group Restrictions).

II. TESTING REQUIREMENTS.

No additional testing requirements exist except as provided in other sections of this permit including Section B (Title V General Requirements) and/or Section E (Source Group Restrictions).

III. MONITORING REQUIREMENTS.

No additional monitoring requirements exist except as provided in other sections of this permit including Section B (Title V General Requirements) and/or Section E (Source Group Restrictions).

IV. RECORDKEEPING REQUIREMENTS.

No additional record keeping requirements exist except as provided in other sections of this permit including Section B (Title V General Requirements) and/or Section E (Source Group Restrictions).

V. REPORTING REQUIREMENTS.

No additional reporting requirements exist except as provided in other sections of this permit including Section B (Title V General Requirements) and/or Section E (Source Group Restrictions).

VI. WORK PRACTICE REQUIREMENTS.

No additional work practice requirements exist except as provided in other sections of this permit including Section B (Title V General Requirements) and/or Section E (Source Group Restrictions).

VII. ADDITIONAL REQUIREMENTS.

No additional requirements exist except as provided in other sections of this permit including Section B (Title V General Requirements) and/or Section E (Source Group Restrictions).

***** Permit Shield in Effect. *****

**SECTION D. Source Level Requirements**

Source ID: 231

Source Name: LEAD OXIDE MILL NO. 31

Source Capacity/Throughput: 0.750 MMBTU/HR

Conditions for this source occur in the following groups: SG 05 OXIDE PLANT

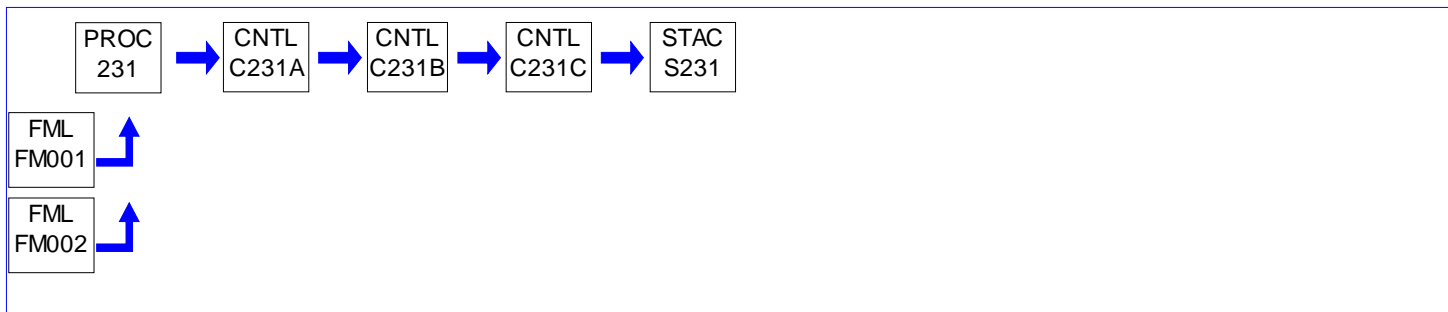
**I. RESTRICTIONS.**

No additional requirements exist except as provided in other sections of this permit including Section B (Title V General Requirements) and/or Section E (Source Group Restrictions).

II. TESTING REQUIREMENTS.

No additional testing requirements exist except as provided in other sections of this permit including Section B (Title V General Requirements) and/or Section E (Source Group Restrictions).

III. MONITORING REQUIREMENTS.

No additional monitoring requirements exist except as provided in other sections of this permit including Section B (Title V General Requirements) and/or Section E (Source Group Restrictions).

IV. RECORDKEEPING REQUIREMENTS.

No additional record keeping requirements exist except as provided in other sections of this permit including Section B (Title V General Requirements) and/or Section E (Source Group Restrictions).

V. REPORTING REQUIREMENTS.

No additional reporting requirements exist except as provided in other sections of this permit including Section B (Title V General Requirements) and/or Section E (Source Group Restrictions).

VI. WORK PRACTICE REQUIREMENTS.

No additional work practice requirements exist except as provided in other sections of this permit including Section B (Title V General Requirements) and/or Section E (Source Group Restrictions).

VII. ADDITIONAL REQUIREMENTS.

No additional requirements exist except as provided in other sections of this permit including Section B (Title V General Requirements) and/or Section E (Source Group Restrictions).

***** Permit Shield in Effect. *****

**SECTION D. Source Level Requirements**

Source ID: 232

Source Name: LEAD OXIDE MILL NO. 32

Source Capacity/Throughput: 0.750 MMBTU/HR

Conditions for this source occur in the following groups: SG 05 OXIDE PLANT

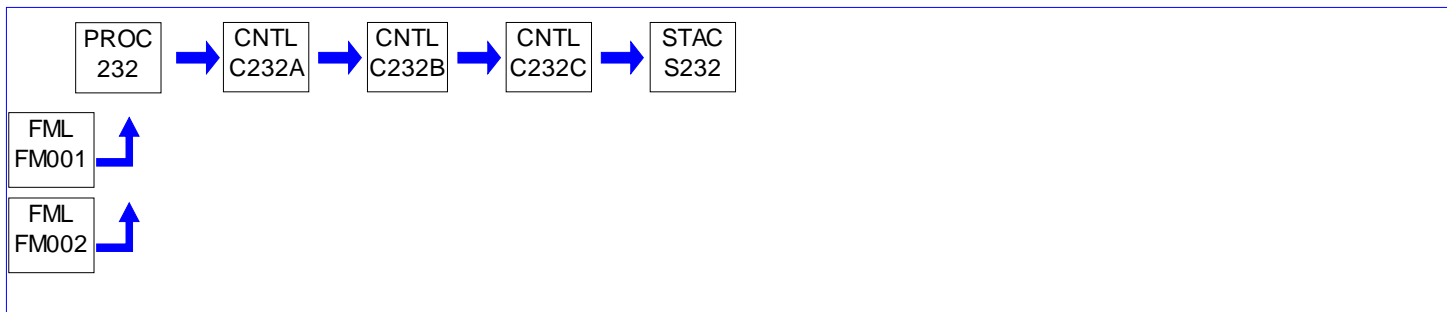
**I. RESTRICTIONS.**

No additional requirements exist except as provided in other sections of this permit including Section B (Title V General Requirements) and/or Section E (Source Group Restrictions).

II. TESTING REQUIREMENTS.

No additional testing requirements exist except as provided in other sections of this permit including Section B (Title V General Requirements) and/or Section E (Source Group Restrictions).

III. MONITORING REQUIREMENTS.

No additional monitoring requirements exist except as provided in other sections of this permit including Section B (Title V General Requirements) and/or Section E (Source Group Restrictions).

IV. RECORDKEEPING REQUIREMENTS.

No additional record keeping requirements exist except as provided in other sections of this permit including Section B (Title V General Requirements) and/or Section E (Source Group Restrictions).

V. REPORTING REQUIREMENTS.

No additional reporting requirements exist except as provided in other sections of this permit including Section B (Title V General Requirements) and/or Section E (Source Group Restrictions).

VI. WORK PRACTICE REQUIREMENTS.

No additional work practice requirements exist except as provided in other sections of this permit including Section B (Title V General Requirements) and/or Section E (Source Group Restrictions).

VII. ADDITIONAL REQUIREMENTS.

No additional requirements exist except as provided in other sections of this permit including Section B (Title V General Requirements) and/or Section E (Source Group Restrictions).

***** Permit Shield in Effect. *****

**SECTION D. Source Level Requirements**

Source ID: 233

Source Name: LEAD OXIDE MILL NO. 33

Source Capacity/Throughput: 0.750 MMBTU/HR

Conditions for this source occur in the following groups: SG 05 OXIDE PLANT

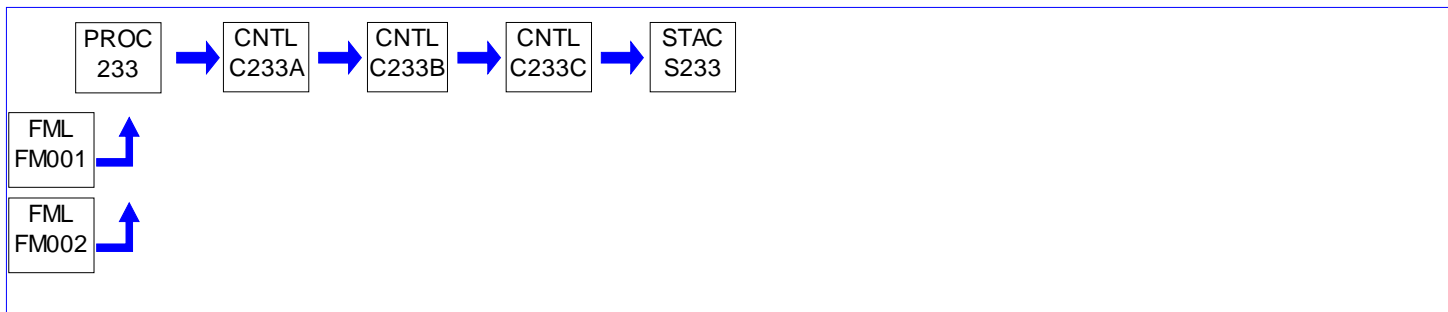
**I. RESTRICTIONS.**

No additional requirements exist except as provided in other sections of this permit including Section B (Title V General Requirements) and/or Section E (Source Group Restrictions).

II. TESTING REQUIREMENTS.

No additional testing requirements exist except as provided in other sections of this permit including Section B (Title V General Requirements) and/or Section E (Source Group Restrictions).

III. MONITORING REQUIREMENTS.

No additional monitoring requirements exist except as provided in other sections of this permit including Section B (Title V General Requirements) and/or Section E (Source Group Restrictions).

IV. RECORDKEEPING REQUIREMENTS.

No additional record keeping requirements exist except as provided in other sections of this permit including Section B (Title V General Requirements) and/or Section E (Source Group Restrictions).

V. REPORTING REQUIREMENTS.

No additional reporting requirements exist except as provided in other sections of this permit including Section B (Title V General Requirements) and/or Section E (Source Group Restrictions).

VI. WORK PRACTICE REQUIREMENTS.

No additional work practice requirements exist except as provided in other sections of this permit including Section B (Title V General Requirements) and/or Section E (Source Group Restrictions).

VII. ADDITIONAL REQUIREMENTS.

No additional requirements exist except as provided in other sections of this permit including Section B (Title V General Requirements) and/or Section E (Source Group Restrictions).

***** Permit Shield in Effect. *****

**SECTION D. Source Level Requirements**

Source ID: 234

Source Name: LEAD OXIDE MILL NO. 34

Source Capacity/Throughput: 0.750 MMBTU/HR

Conditions for this source occur in the following groups: SG 05 OXIDE PLANT

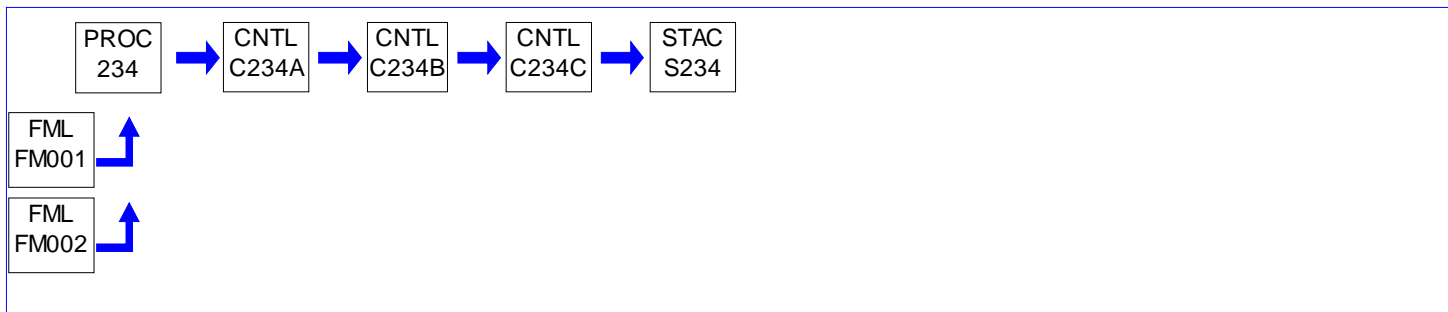
**I. RESTRICTIONS.**

No additional requirements exist except as provided in other sections of this permit including Section B (Title V General Requirements) and/or Section E (Source Group Restrictions).

II. TESTING REQUIREMENTS.

No additional testing requirements exist except as provided in other sections of this permit including Section B (Title V General Requirements) and/or Section E (Source Group Restrictions).

III. MONITORING REQUIREMENTS.

No additional monitoring requirements exist except as provided in other sections of this permit including Section B (Title V General Requirements) and/or Section E (Source Group Restrictions).

IV. RECORDKEEPING REQUIREMENTS.

No additional record keeping requirements exist except as provided in other sections of this permit including Section B (Title V General Requirements) and/or Section E (Source Group Restrictions).

V. REPORTING REQUIREMENTS.

No additional reporting requirements exist except as provided in other sections of this permit including Section B (Title V General Requirements) and/or Section E (Source Group Restrictions).

VI. WORK PRACTICE REQUIREMENTS.

No additional work practice requirements exist except as provided in other sections of this permit including Section B (Title V General Requirements) and/or Section E (Source Group Restrictions).

VII. ADDITIONAL REQUIREMENTS.

No additional requirements exist except as provided in other sections of this permit including Section B (Title V General Requirements) and/or Section E (Source Group Restrictions).

***** Permit Shield in Effect. *****

**SECTION D. Source Level Requirements**

Source ID: 235

Source Name: LEAD OXIDE MILL NO. 35 (A-4)

Source Capacity/Throughput:	2,600.000 Lbs/HR	LEAD OXIDE
	500.000 CF/HR	Natural Gas
	8.300 Gal/HR	Propane

Conditions for this source occur in the following groups: SG 05 OXIDE PLANT

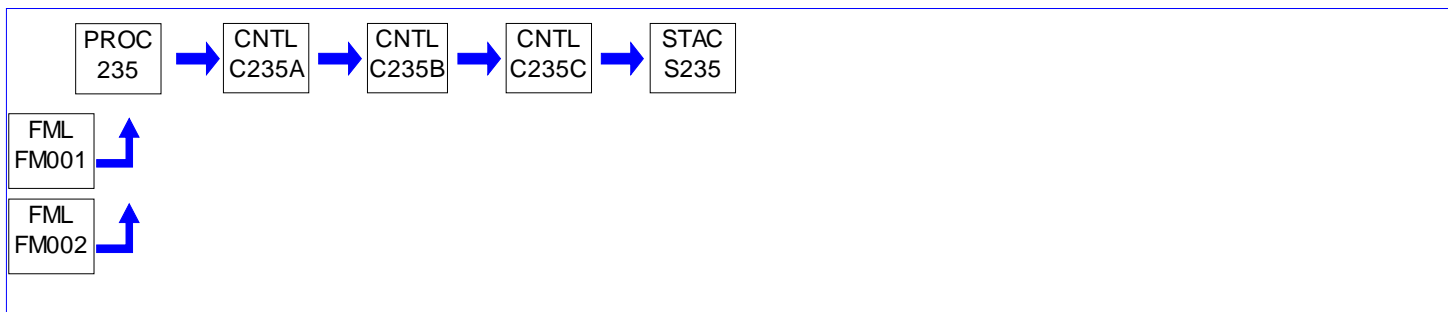
**I. RESTRICTIONS.**

No additional requirements exist except as provided in other sections of this permit including Section B (Title V General Requirements) and/or Section E (Source Group Restrictions).

II. TESTING REQUIREMENTS.

No additional testing requirements exist except as provided in other sections of this permit including Section B (Title V General Requirements) and/or Section E (Source Group Restrictions).

III. MONITORING REQUIREMENTS.

No additional monitoring requirements exist except as provided in other sections of this permit including Section B (Title V General Requirements) and/or Section E (Source Group Restrictions).

IV. RECORDKEEPING REQUIREMENTS.

No additional record keeping requirements exist except as provided in other sections of this permit including Section B (Title V General Requirements) and/or Section E (Source Group Restrictions).

V. REPORTING REQUIREMENTS.

No additional reporting requirements exist except as provided in other sections of this permit including Section B (Title V General Requirements) and/or Section E (Source Group Restrictions).

VI. WORK PRACTICE REQUIREMENTS.

No additional work practice requirements exist except as provided in other sections of this permit including Section B (Title V General Requirements) and/or Section E (Source Group Restrictions).

VII. ADDITIONAL REQUIREMENTS.

No additional requirements exist except as provided in other sections of this permit including Section B (Title V General Requirements) and/or Section E (Source Group Restrictions).

***** Permit Shield in Effect. *****

**SECTION D. Source Level Requirements**

Source ID: 236

Source Name: LEAD OXIDE MILL NO. 36 (A-4)

Source Capacity/Throughput:	2,600.000 Lbs/HR	LEAD OXIDE
	500.000 CF/HR	Natural Gas
	8.300 Gal/HR	Propane

Conditions for this source occur in the following groups: SG 05 OXIDE PLANT

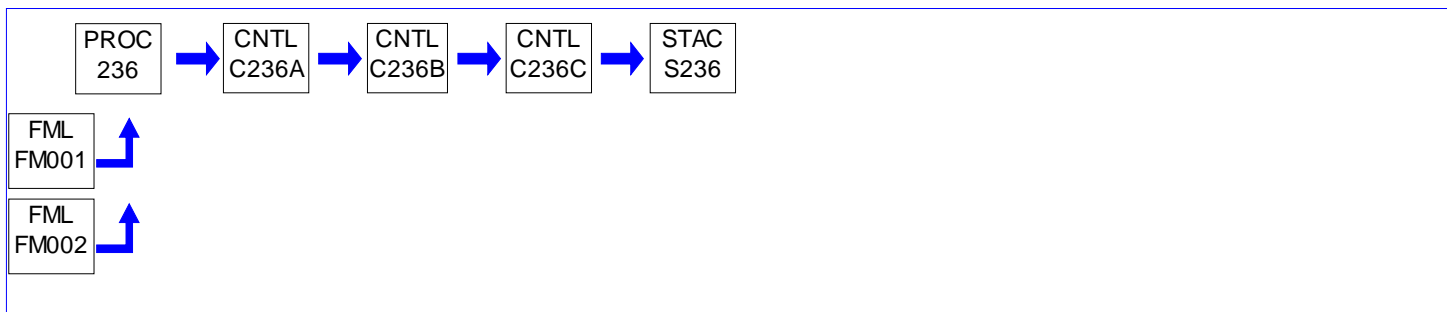
**I. RESTRICTIONS.**

No additional requirements exist except as provided in other sections of this permit including Section B (Title V General Requirements) and/or Section E (Source Group Restrictions).

II. TESTING REQUIREMENTS.

No additional testing requirements exist except as provided in other sections of this permit including Section B (Title V General Requirements) and/or Section E (Source Group Restrictions).

III. MONITORING REQUIREMENTS.

No additional monitoring requirements exist except as provided in other sections of this permit including Section B (Title V General Requirements) and/or Section E (Source Group Restrictions).

IV. RECORDKEEPING REQUIREMENTS.

No additional record keeping requirements exist except as provided in other sections of this permit including Section B (Title V General Requirements) and/or Section E (Source Group Restrictions).

V. REPORTING REQUIREMENTS.

No additional reporting requirements exist except as provided in other sections of this permit including Section B (Title V General Requirements) and/or Section E (Source Group Restrictions).

VI. WORK PRACTICE REQUIREMENTS.

No additional work practice requirements exist except as provided in other sections of this permit including Section B (Title V General Requirements) and/or Section E (Source Group Restrictions).

VII. ADDITIONAL REQUIREMENTS.

No additional requirements exist except as provided in other sections of this permit including Section B (Title V General Requirements) and/or Section E (Source Group Restrictions).

***** Permit Shield in Effect. *****

**SECTION D. Source Level Requirements**

Source ID: 237

Source Name: LEAD OXIDE MILL NO. 37 (A-4)

Source Capacity/Throughput:	2,600.000 Lbs/HR	LEAD OXIDE
	500.000 CF/HR	Natural Gas
	8.300 Gal/HR	Propane

Conditions for this source occur in the following groups: SG 05 OXIDE PLANT

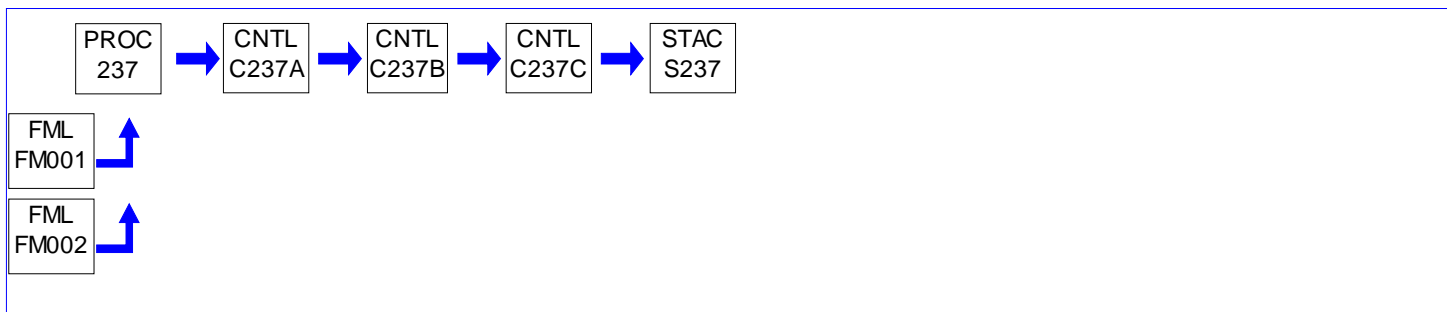
**I. RESTRICTIONS.**

No additional requirements exist except as provided in other sections of this permit including Section B (Title V General Requirements) and/or Section E (Source Group Restrictions).

II. TESTING REQUIREMENTS.

No additional testing requirements exist except as provided in other sections of this permit including Section B (Title V General Requirements) and/or Section E (Source Group Restrictions).

III. MONITORING REQUIREMENTS.

No additional monitoring requirements exist except as provided in other sections of this permit including Section B (Title V General Requirements) and/or Section E (Source Group Restrictions).

IV. RECORDKEEPING REQUIREMENTS.

No additional record keeping requirements exist except as provided in other sections of this permit including Section B (Title V General Requirements) and/or Section E (Source Group Restrictions).

V. REPORTING REQUIREMENTS.

No additional reporting requirements exist except as provided in other sections of this permit including Section B (Title V General Requirements) and/or Section E (Source Group Restrictions).

VI. WORK PRACTICE REQUIREMENTS.

No additional work practice requirements exist except as provided in other sections of this permit including Section B (Title V General Requirements) and/or Section E (Source Group Restrictions).

VII. ADDITIONAL REQUIREMENTS.

No additional requirements exist except as provided in other sections of this permit including Section B (Title V General Requirements) and/or Section E (Source Group Restrictions).

***** Permit Shield in Effect. *****

**SECTION D. Source Level Requirements**

Source ID: 238

Source Name: LEAD OXIDE MILL NO. 38 (A-4)

Source Capacity/Throughput:	2,600.000 Lbs/HR	LEAD OXIDE
	500.000 CF/HR	Natural Gas
	8.300 Gal/HR	Propane

Conditions for this source occur in the following groups: SG 05 OXIDE PLANT

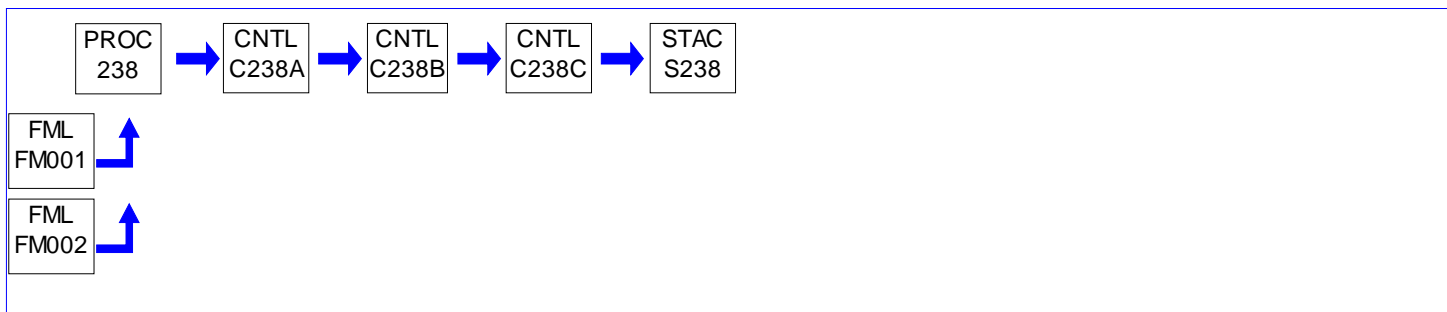
**I. RESTRICTIONS.**

No additional requirements exist except as provided in other sections of this permit including Section B (Title V General Requirements) and/or Section E (Source Group Restrictions).

II. TESTING REQUIREMENTS.

No additional testing requirements exist except as provided in other sections of this permit including Section B (Title V General Requirements) and/or Section E (Source Group Restrictions).

III. MONITORING REQUIREMENTS.

No additional monitoring requirements exist except as provided in other sections of this permit including Section B (Title V General Requirements) and/or Section E (Source Group Restrictions).

IV. RECORDKEEPING REQUIREMENTS.

No additional record keeping requirements exist except as provided in other sections of this permit including Section B (Title V General Requirements) and/or Section E (Source Group Restrictions).

V. REPORTING REQUIREMENTS.

No additional reporting requirements exist except as provided in other sections of this permit including Section B (Title V General Requirements) and/or Section E (Source Group Restrictions).

VI. WORK PRACTICE REQUIREMENTS.

No additional work practice requirements exist except as provided in other sections of this permit including Section B (Title V General Requirements) and/or Section E (Source Group Restrictions).

VII. ADDITIONAL REQUIREMENTS.

No additional requirements exist except as provided in other sections of this permit including Section B (Title V General Requirements) and/or Section E (Source Group Restrictions).

***** Permit Shield in Effect. *****

**SECTION D. Source Level Requirements**

Source ID: 239

Source Name: LEAD OXIDE MILL NO. 39 (A-4)

Source Capacity/Throughput:	2,600.000 Lbs/HR	LEAD OXIDE
	500.000 CF/HR	Natural Gas
	8.300 Gal/HR	Propane

Conditions for this source occur in the following groups: SG 05 OXIDE PLANT

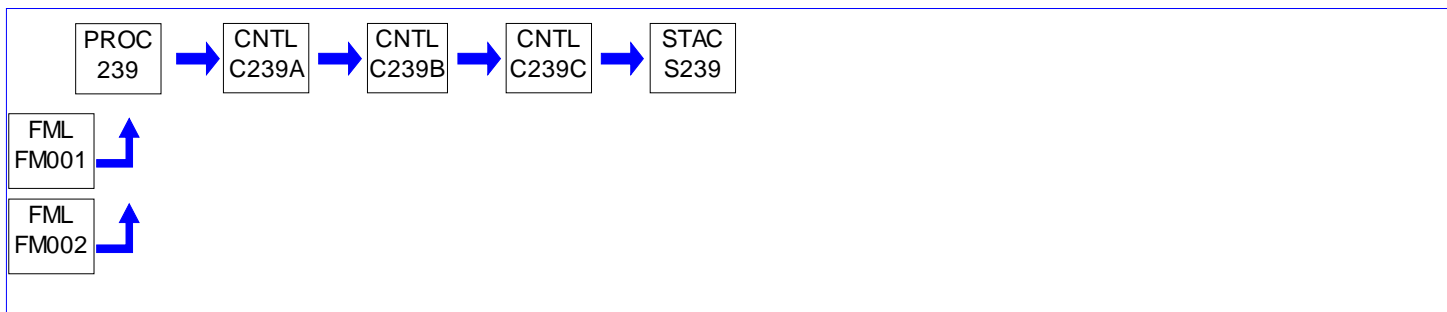
**I. RESTRICTIONS.**

No additional requirements exist except as provided in other sections of this permit including Section B (Title V General Requirements) and/or Section E (Source Group Restrictions).

II. TESTING REQUIREMENTS.

No additional testing requirements exist except as provided in other sections of this permit including Section B (Title V General Requirements) and/or Section E (Source Group Restrictions).

III. MONITORING REQUIREMENTS.

No additional monitoring requirements exist except as provided in other sections of this permit including Section B (Title V General Requirements) and/or Section E (Source Group Restrictions).

IV. RECORDKEEPING REQUIREMENTS.

No additional record keeping requirements exist except as provided in other sections of this permit including Section B (Title V General Requirements) and/or Section E (Source Group Restrictions).

V. REPORTING REQUIREMENTS.

No additional reporting requirements exist except as provided in other sections of this permit including Section B (Title V General Requirements) and/or Section E (Source Group Restrictions).

VI. WORK PRACTICE REQUIREMENTS.

No additional work practice requirements exist except as provided in other sections of this permit including Section B (Title V General Requirements) and/or Section E (Source Group Restrictions).

VII. ADDITIONAL REQUIREMENTS.

No additional requirements exist except as provided in other sections of this permit including Section B (Title V General Requirements) and/or Section E (Source Group Restrictions).

***** Permit Shield in Effect. *****

**SECTION D. Source Level Requirements**

Source ID: 240

Source Name: LEAD OXIDE MILL NO. 40 (A-4)

Source Capacity/Throughput:	2,600.000 Lbs/HR	LEAD OXIDE
	500.000 CF/HR	Natural Gas
	8.300 Gal/HR	Propane

Conditions for this source occur in the following groups: SG 05 OXIDE PLANT

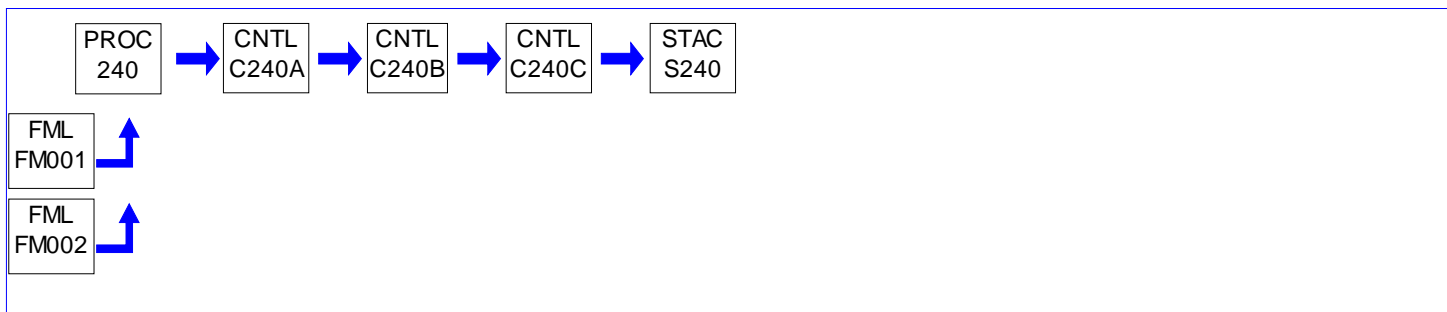
**I. RESTRICTIONS.**

No additional requirements exist except as provided in other sections of this permit including Section B (Title V General Requirements) and/or Section E (Source Group Restrictions).

II. TESTING REQUIREMENTS.

No additional testing requirements exist except as provided in other sections of this permit including Section B (Title V General Requirements) and/or Section E (Source Group Restrictions).

III. MONITORING REQUIREMENTS.

No additional monitoring requirements exist except as provided in other sections of this permit including Section B (Title V General Requirements) and/or Section E (Source Group Restrictions).

IV. RECORDKEEPING REQUIREMENTS.

No additional record keeping requirements exist except as provided in other sections of this permit including Section B (Title V General Requirements) and/or Section E (Source Group Restrictions).

V. REPORTING REQUIREMENTS.

No additional reporting requirements exist except as provided in other sections of this permit including Section B (Title V General Requirements) and/or Section E (Source Group Restrictions).

VI. WORK PRACTICE REQUIREMENTS.

No additional work practice requirements exist except as provided in other sections of this permit including Section B (Title V General Requirements) and/or Section E (Source Group Restrictions).

VII. ADDITIONAL REQUIREMENTS.

No additional requirements exist except as provided in other sections of this permit including Section B (Title V General Requirements) and/or Section E (Source Group Restrictions).

***** Permit Shield in Effect. *****

**SECTION D. Source Level Requirements**

Source ID: 301

Source Name: S-1A BATT ASSEMBLY ANNEX (SCIENTIFIC FC 6)

Source Capacity/Throughput: 300.000 Each/HR STORAGE BATTERIES

Conditions for this source occur in the following groups: SG 06 S-1 BATTERY ASSEMBLY
SG12 BAGHOUSE CAM

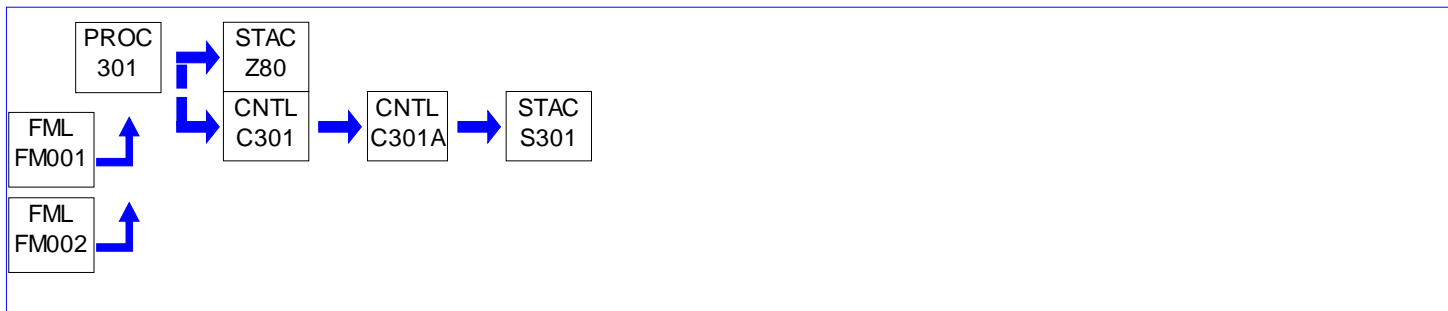
**I. RESTRICTIONS.**

No additional requirements exist except as provided in other sections of this permit including Section B (Title V General Requirements) and/or Section E (Source Group Restrictions).

II. TESTING REQUIREMENTS.

No additional testing requirements exist except as provided in other sections of this permit including Section B (Title V General Requirements) and/or Section E (Source Group Restrictions).

III. MONITORING REQUIREMENTS.

No additional monitoring requirements exist except as provided in other sections of this permit including Section B (Title V General Requirements) and/or Section E (Source Group Restrictions).

IV. RECORDKEEPING REQUIREMENTS.

No additional record keeping requirements exist except as provided in other sections of this permit including Section B (Title V General Requirements) and/or Section E (Source Group Restrictions).

V. REPORTING REQUIREMENTS.

No additional reporting requirements exist except as provided in other sections of this permit including Section B (Title V General Requirements) and/or Section E (Source Group Restrictions).

VI. WORK PRACTICE REQUIREMENTS.

No additional work practice requirements exist except as provided in other sections of this permit including Section B (Title V General Requirements) and/or Section E (Source Group Restrictions).

VII. ADDITIONAL REQUIREMENTS.

No additional requirements exist except as provided in other sections of this permit including Section B (Title V General Requirements) and/or Section E (Source Group Restrictions).

***** Permit Shield in Effect. *****

**SECTION D. Source Level Requirements**

Source ID: 303

Source Name: S-1 SILICON DIOXIDE SILO (1 BIN VENT)

Source Capacity/Throughput:

**I. RESTRICTIONS.****Emission Restriction(s).**

001 [25 Pa. Code §127.441]

Operating permit terms and conditions.

The permittee shall limit the particulate emissions to the outdoor atmosphere to 0.01 grains per dry standard cubic foot.

002 [25 Pa. Code §127.441]

Operating permit terms and conditions.

The operation of the silo shall not result in visible emissions to the outdoor atmosphere.

II. TESTING REQUIREMENTS.

No additional testing requirements exist except as provided in other sections of this permit including Section B (Title V General Requirements).

III. MONITORING REQUIREMENTS.

003 [25 Pa. Code §127.441]

Operating permit terms and conditions.

The permittee shall periodically read and record the pressure drop across the bin vent during the loading of the silo. The frequency of these readings shall be monthly, except as provided in the Section C 90% Monitoring Condition.

IV. RECORDKEEPING REQUIREMENTS.

004 [25 Pa. Code §127.441]

Operating permit terms and conditions.

The permittee shall record all monitoring and inspection results in a manner approved by the Department.

V. REPORTING REQUIREMENTS.

No additional reporting requirements exist except as provided in other sections of this permit including Section B (Title V General Requirements).

VI. WORK PRACTICE REQUIREMENTS.

005 [25 Pa. Code §127.441]

Operating permit terms and conditions.

Equipment (a differential manometer or equivalent, as approved by the Department), shall be installed and maintained so that at any time the pressure drop across the bin vent can be measured.

006 [25 Pa. Code §127.441]

Operating permit terms and conditions.

Annually the permittee shall inspect the silo and bin vent for the following:

**SECTION D. Source Level Requirements**

- a. Wear and damage
- b. Removal of collected material
- c. Fugitive emissions
- d. Cleaning cycles

VII. ADDITIONAL REQUIREMENTS.

No additional requirements exist except as provided in other sections of this permit including Section B (Title V General Requirements).

***** Permit Shield in Effect. *****

**SECTION D. Source Level Requirements**

Source ID: 401

Source Name: A-4 LEAD OXIDE STORAGE SILOS (9) (BIN VENTS)

Source Capacity/Throughput:

Conditions for this source occur in the following groups: SG 08 A-4 BATTERY ASSEMBLY PLANT
SG13 BIN VENT CAM

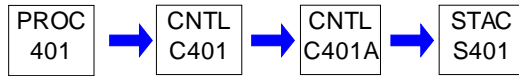
**I. RESTRICTIONS.**

No additional requirements exist except as provided in other sections of this permit including Section B (Title V General Requirements) and/or Section E (Source Group Restrictions).

II. TESTING REQUIREMENTS.

No additional testing requirements exist except as provided in other sections of this permit including Section B (Title V General Requirements) and/or Section E (Source Group Restrictions).

III. MONITORING REQUIREMENTS.

No additional monitoring requirements exist except as provided in other sections of this permit including Section B (Title V General Requirements) and/or Section E (Source Group Restrictions).

IV. RECORDKEEPING REQUIREMENTS.

No additional record keeping requirements exist except as provided in other sections of this permit including Section B (Title V General Requirements) and/or Section E (Source Group Restrictions).

V. REPORTING REQUIREMENTS.

No additional reporting requirements exist except as provided in other sections of this permit including Section B (Title V General Requirements) and/or Section E (Source Group Restrictions).

VI. WORK PRACTICE REQUIREMENTS.

No additional work practice requirements exist except as provided in other sections of this permit including Section B (Title V General Requirements) and/or Section E (Source Group Restrictions).

VII. ADDITIONAL REQUIREMENTS.

No additional requirements exist except as provided in other sections of this permit including Section B (Title V General Requirements) and/or Section E (Source Group Restrictions).

***** Permit Shield in Effect. *****

**SECTION D. Source Level Requirements**

Source ID: 402

Source Name: A-4 MIXING (SCIEN #6) & PASTING (SCIEN #1)

Source Capacity/Throughput: 4.800 MMBTU/HR

Conditions for this source occur in the following groups: SG 08 A-4 BATTERY ASSEMBLY PLANT
SG12 BAGHOUSE CAM

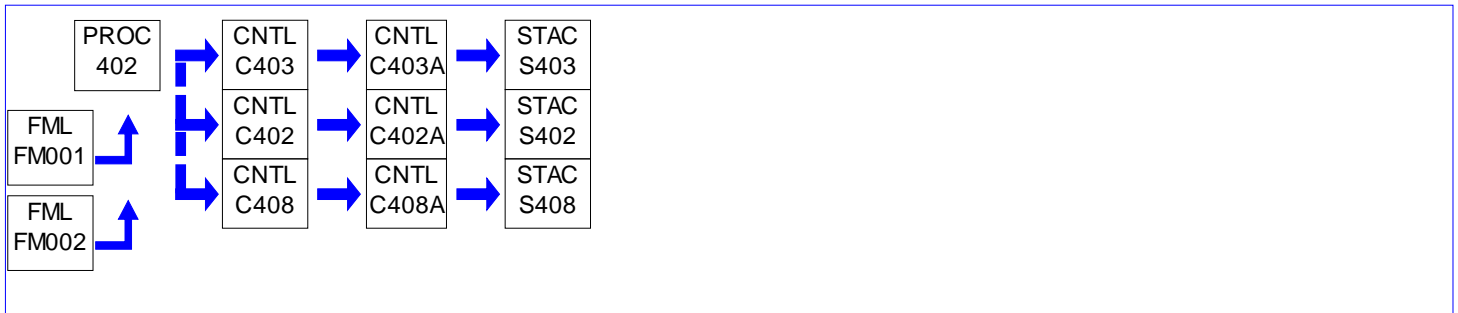
**I. RESTRICTIONS.**

No additional requirements exist except as provided in other sections of this permit including Section B (Title V General Requirements) and/or Section E (Source Group Restrictions).

II. TESTING REQUIREMENTS.

No additional testing requirements exist except as provided in other sections of this permit including Section B (Title V General Requirements) and/or Section E (Source Group Restrictions).

III. MONITORING REQUIREMENTS.

No additional monitoring requirements exist except as provided in other sections of this permit including Section B (Title V General Requirements) and/or Section E (Source Group Restrictions).

IV. RECORDKEEPING REQUIREMENTS.

No additional record keeping requirements exist except as provided in other sections of this permit including Section B (Title V General Requirements) and/or Section E (Source Group Restrictions).

V. REPORTING REQUIREMENTS.

No additional reporting requirements exist except as provided in other sections of this permit including Section B (Title V General Requirements) and/or Section E (Source Group Restrictions).

VI. WORK PRACTICE REQUIREMENTS.

No additional work practice requirements exist except as provided in other sections of this permit including Section B (Title V General Requirements) and/or Section E (Source Group Restrictions).

VII. ADDITIONAL REQUIREMENTS.

No additional requirements exist except as provided in other sections of this permit including Section B (Title V General Requirements) and/or Section E (Source Group Restrictions).

***** Permit Shield in Effect. *****

**SECTION D. Source Level Requirements**

Source ID: 403

Source Name: A-4 GRIDCASTING (SCIEN FC #2)

Source Capacity/Throughput: 10.000 MMBTU/HR

Conditions for this source occur in the following groups: SG 08 A-4 BATTERY ASSEMBLY PLANT
SG12 BAGHOUSE CAM

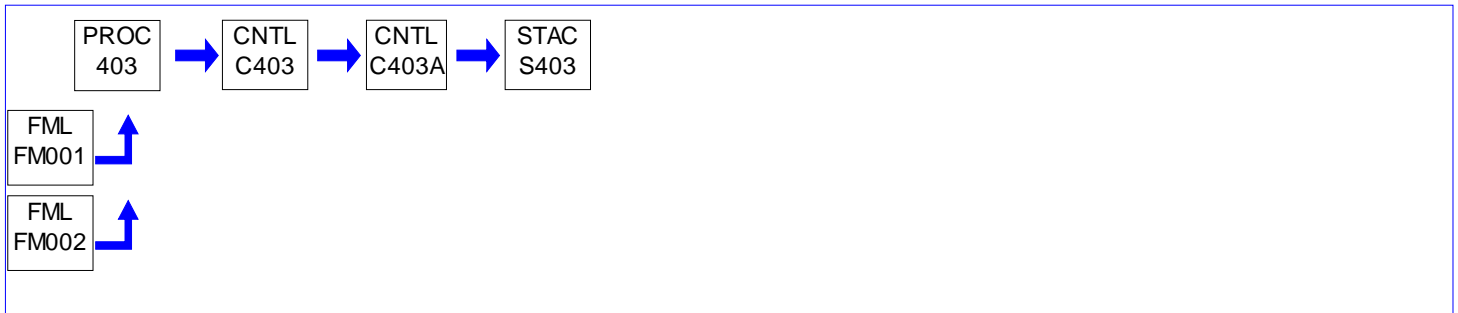
**I. RESTRICTIONS.**

No additional requirements exist except as provided in other sections of this permit including Section B (Title V General Requirements) and/or Section E (Source Group Restrictions).

II. TESTING REQUIREMENTS.

No additional testing requirements exist except as provided in other sections of this permit including Section B (Title V General Requirements) and/or Section E (Source Group Restrictions).

III. MONITORING REQUIREMENTS.

No additional monitoring requirements exist except as provided in other sections of this permit including Section B (Title V General Requirements) and/or Section E (Source Group Restrictions).

IV. RECORDKEEPING REQUIREMENTS.

No additional record keeping requirements exist except as provided in other sections of this permit including Section B (Title V General Requirements) and/or Section E (Source Group Restrictions).

V. REPORTING REQUIREMENTS.

No additional reporting requirements exist except as provided in other sections of this permit including Section B (Title V General Requirements) and/or Section E (Source Group Restrictions).

VI. WORK PRACTICE REQUIREMENTS.

No additional work practice requirements exist except as provided in other sections of this permit including Section B (Title V General Requirements) and/or Section E (Source Group Restrictions).

VII. ADDITIONAL REQUIREMENTS.

No additional requirements exist except as provided in other sections of this permit including Section B (Title V General Requirements) and/or Section E (Source Group Restrictions).

***** Permit Shield in Effect. *****

**SECTION D. Source Level Requirements**

Source ID: 404

Source Name: A-4 CONCASTING (SCIEN FC #2)

Source Capacity/Throughput: 2.000 MMBTU/HR

Conditions for this source occur in the following groups: SG 08 A-4 BATTERY ASSEMBLY PLANT
 SG10B RACT 2
 SG12 BAGHOUSE CAM
 SG20 RACT III PRESUMPTIVE

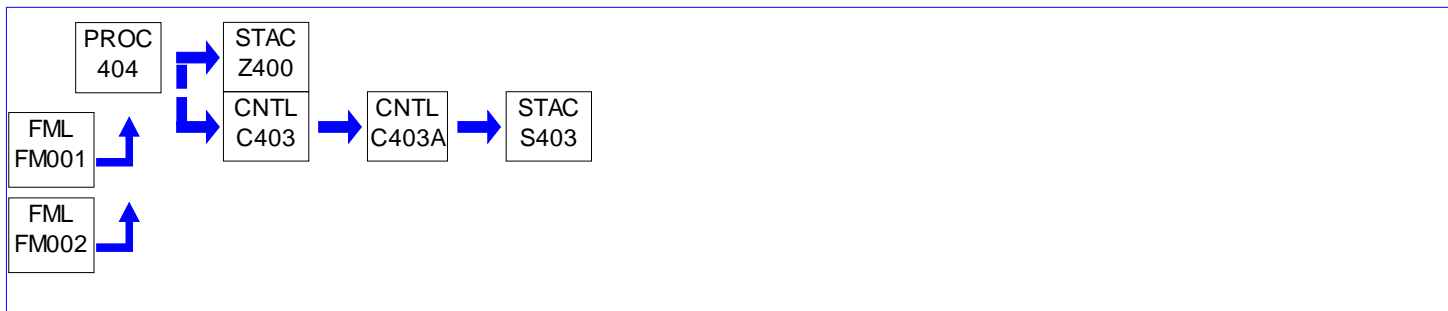
**I. RESTRICTIONS.**

No additional requirements exist except as provided in other sections of this permit including Section B (Title V General Requirements) and/or Section E (Source Group Restrictions).

II. TESTING REQUIREMENTS.

No additional testing requirements exist except as provided in other sections of this permit including Section B (Title V General Requirements) and/or Section E (Source Group Restrictions).

III. MONITORING REQUIREMENTS.

No additional monitoring requirements exist except as provided in other sections of this permit including Section B (Title V General Requirements) and/or Section E (Source Group Restrictions).

IV. RECORDKEEPING REQUIREMENTS.

No additional record keeping requirements exist except as provided in other sections of this permit including Section B (Title V General Requirements) and/or Section E (Source Group Restrictions).

V. REPORTING REQUIREMENTS.

No additional reporting requirements exist except as provided in other sections of this permit including Section B (Title V General Requirements) and/or Section E (Source Group Restrictions).

VI. WORK PRACTICE REQUIREMENTS.

No additional work practice requirements exist except as provided in other sections of this permit including Section B (Title V General Requirements) and/or Section E (Source Group Restrictions).

VII. ADDITIONAL REQUIREMENTS.

No additional requirements exist except as provided in other sections of this permit including Section B (Title V General Requirements) and/or Section E (Source Group Restrictions).



SECTION D. Source Level Requirements

***** Permit Shield in Effect. *****

**SECTION D. Source Level Requirements**

Source ID: 405

Source Name: A-4 THREE-PROCESS-OPR (FC #3 & #4 & #7)

Source Capacity/Throughput: 0.800 MMBTU/HR

Conditions for this source occur in the following groups: SG 08 A-4 BATTERY ASSEMBLY PLANT
SG12 BAGHOUSE CAM

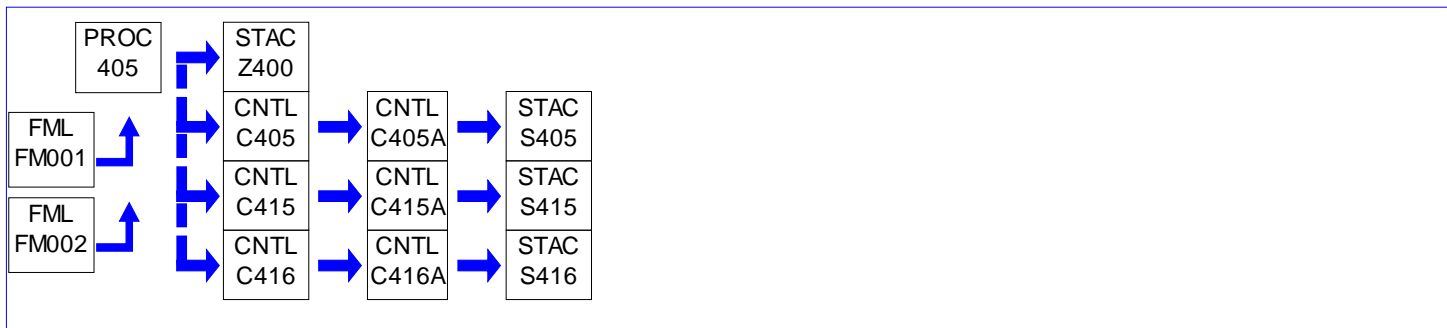
**I. RESTRICTIONS.**

No additional requirements exist except as provided in other sections of this permit including Section B (Title V General Requirements) and/or Section E (Source Group Restrictions).

II. TESTING REQUIREMENTS.

No additional testing requirements exist except as provided in other sections of this permit including Section B (Title V General Requirements) and/or Section E (Source Group Restrictions).

III. MONITORING REQUIREMENTS.

No additional monitoring requirements exist except as provided in other sections of this permit including Section B (Title V General Requirements) and/or Section E (Source Group Restrictions).

IV. RECORDKEEPING REQUIREMENTS.

No additional record keeping requirements exist except as provided in other sections of this permit including Section B (Title V General Requirements) and/or Section E (Source Group Restrictions).

V. REPORTING REQUIREMENTS.

No additional reporting requirements exist except as provided in other sections of this permit including Section B (Title V General Requirements) and/or Section E (Source Group Restrictions).

VI. WORK PRACTICE REQUIREMENTS.

No additional work practice requirements exist except as provided in other sections of this permit including Section B (Title V General Requirements) and/or Section E (Source Group Restrictions).

VII. ADDITIONAL REQUIREMENTS.

No additional requirements exist except as provided in other sections of this permit including Section B (Title V General Requirements) and/or Section E (Source Group Restrictions).

*** Permit Shield in Effect. ***

**SECTION D. Source Level Requirements**

Source ID: 406

Source Name: A-4 BATTERY FORMATION (9) (MIST ELIM)

Source Capacity/Throughput:

Conditions for this source occur in the following groups: SG 08 A-4 BATTERY ASSEMBLY PLANT
SG17 MIST ELIMINATOR CAM

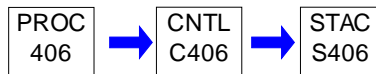
**I. RESTRICTIONS.**

No additional requirements exist except as provided in other sections of this permit including Section B (Title V General Requirements) and/or Section E (Source Group Restrictions).

II. TESTING REQUIREMENTS.

No additional testing requirements exist except as provided in other sections of this permit including Section B (Title V General Requirements) and/or Section E (Source Group Restrictions).

III. MONITORING REQUIREMENTS.

No additional monitoring requirements exist except as provided in other sections of this permit including Section B (Title V General Requirements) and/or Section E (Source Group Restrictions).

IV. RECORDKEEPING REQUIREMENTS.

No additional record keeping requirements exist except as provided in other sections of this permit including Section B (Title V General Requirements) and/or Section E (Source Group Restrictions).

V. REPORTING REQUIREMENTS.

No additional reporting requirements exist except as provided in other sections of this permit including Section B (Title V General Requirements) and/or Section E (Source Group Restrictions).

VI. WORK PRACTICE REQUIREMENTS.

No additional work practice requirements exist except as provided in other sections of this permit including Section B (Title V General Requirements) and/or Section E (Source Group Restrictions).

VII. ADDITIONAL REQUIREMENTS.

No additional requirements exist except as provided in other sections of this permit including Section B (Title V General Requirements) and/or Section E (Source Group Restrictions).

***** Permit Shield in Effect. *****

**SECTION D. Source Level Requirements**

Source ID: 407

Source Name: A-4 BATT ASSEMBLY LINES (SCIEN FC #5)

Source Capacity/Throughput:

Conditions for this source occur in the following groups: SG 08 A-4 BATTERY ASSEMBLY PLANT
SG12 BAGHOUSE CAM

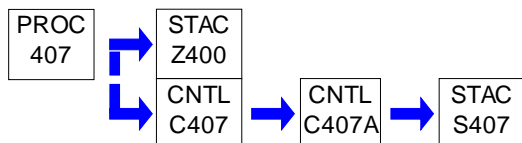
**I. RESTRICTIONS.**

No additional requirements exist except as provided in other sections of this permit including Section B (Title V General Requirements) and/or Section E (Source Group Restrictions).

II. TESTING REQUIREMENTS.

No additional testing requirements exist except as provided in other sections of this permit including Section B (Title V General Requirements) and/or Section E (Source Group Restrictions).

III. MONITORING REQUIREMENTS.

No additional monitoring requirements exist except as provided in other sections of this permit including Section B (Title V General Requirements) and/or Section E (Source Group Restrictions).

IV. RECORDKEEPING REQUIREMENTS.

No additional record keeping requirements exist except as provided in other sections of this permit including Section B (Title V General Requirements) and/or Section E (Source Group Restrictions).

V. REPORTING REQUIREMENTS.

No additional reporting requirements exist except as provided in other sections of this permit including Section B (Title V General Requirements) and/or Section E (Source Group Restrictions).

VI. WORK PRACTICE REQUIREMENTS.

No additional work practice requirements exist except as provided in other sections of this permit including Section B (Title V General Requirements) and/or Section E (Source Group Restrictions).

VII. ADDITIONAL REQUIREMENTS.

No additional requirements exist except as provided in other sections of this permit including Section B (Title V General Requirements) and/or Section E (Source Group Restrictions).

***** Permit Shield in Effect. *****

**SECTION D. Source Level Requirements**

Source ID: 502

Source Name: A-2 SMALL PARTS CASTING (FUGITIVE/UNCONTROL)

Source Capacity/Throughput: 1,100.000 Each/HR STORAGE BATTERIES

Conditions for this source occur in the following groups: SG 02 A-2 BATTERY ASSEMBLY

**I. RESTRICTIONS.**

No additional requirements exist except as provided in other sections of this permit including Section B (Title V General Requirements) and/or Section E (Source Group Restrictions).

II. TESTING REQUIREMENTS.

No additional testing requirements exist except as provided in other sections of this permit including Section B (Title V General Requirements) and/or Section E (Source Group Restrictions).

III. MONITORING REQUIREMENTS.

No additional monitoring requirements exist except as provided in other sections of this permit including Section B (Title V General Requirements) and/or Section E (Source Group Restrictions).

IV. RECORDKEEPING REQUIREMENTS.

No additional record keeping requirements exist except as provided in other sections of this permit including Section B (Title V General Requirements) and/or Section E (Source Group Restrictions).

V. REPORTING REQUIREMENTS.

No additional reporting requirements exist except as provided in other sections of this permit including Section B (Title V General Requirements) and/or Section E (Source Group Restrictions).

VI. WORK PRACTICE REQUIREMENTS.

No additional work practice requirements exist except as provided in other sections of this permit including Section B (Title V General Requirements) and/or Section E (Source Group Restrictions).

VII. ADDITIONAL REQUIREMENTS.

No additional requirements exist except as provided in other sections of this permit including Section B (Title V General Requirements) and/or Section E (Source Group Restrictions).

***** Permit Shield in Effect. *****

**SECTION D. Source Level Requirements**

Source ID: 503

Source Name: A-2 RED LEAD OXIDE STORAGE SILO (BIN VENT)

Source Capacity/Throughput: 10.000 Tons/HR LEAD OXIDE RED

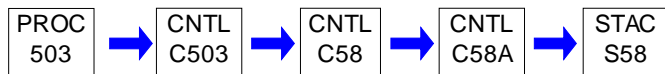
Conditions for this source occur in the following groups: SG 02 A-2 BATTERY ASSEMBLY
SG12 BAGHOUSE CAM**I. RESTRICTIONS.**

No additional requirements exist except as provided in other sections of this permit including Section B (Title V General Requirements) and/or Section E (Source Group Restrictions).

II. TESTING REQUIREMENTS.

No additional testing requirements exist except as provided in other sections of this permit including Section B (Title V General Requirements) and/or Section E (Source Group Restrictions).

III. MONITORING REQUIREMENTS.

No additional monitoring requirements exist except as provided in other sections of this permit including Section B (Title V General Requirements) and/or Section E (Source Group Restrictions).

IV. RECORDKEEPING REQUIREMENTS.

No additional record keeping requirements exist except as provided in other sections of this permit including Section B (Title V General Requirements) and/or Section E (Source Group Restrictions).

V. REPORTING REQUIREMENTS.

No additional reporting requirements exist except as provided in other sections of this permit including Section B (Title V General Requirements) and/or Section E (Source Group Restrictions).

VI. WORK PRACTICE REQUIREMENTS.

No additional work practice requirements exist except as provided in other sections of this permit including Section B (Title V General Requirements) and/or Section E (Source Group Restrictions).

VII. ADDITIONAL REQUIREMENTS.

No additional requirements exist except as provided in other sections of this permit including Section B (Title V General Requirements) and/or Section E (Source Group Restrictions).

***** Permit Shield in Effect. *****

**SECTION D. Source Level Requirements**

Source ID: 504

Source Name: A-1 SMALL PARTS CASTING (FUGITIVE/UNCONTROL)

Source Capacity/Throughput: 200.000 Each/HR STORAGE BATTERIES

Conditions for this source occur in the following groups: SG 01 A-1 BATTERY ASSEMBLY

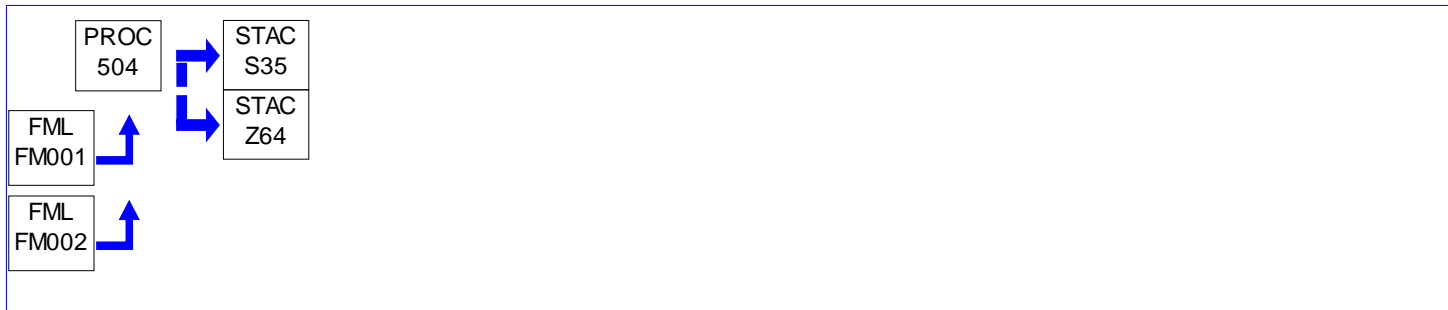
**I. RESTRICTIONS.**

No additional requirements exist except as provided in other sections of this permit including Section B (Title V General Requirements) and/or Section E (Source Group Restrictions).

II. TESTING REQUIREMENTS.

No additional testing requirements exist except as provided in other sections of this permit including Section B (Title V General Requirements) and/or Section E (Source Group Restrictions).

III. MONITORING REQUIREMENTS.

No additional monitoring requirements exist except as provided in other sections of this permit including Section B (Title V General Requirements) and/or Section E (Source Group Restrictions).

IV. RECORDKEEPING REQUIREMENTS.

No additional record keeping requirements exist except as provided in other sections of this permit including Section B (Title V General Requirements) and/or Section E (Source Group Restrictions).

V. REPORTING REQUIREMENTS.

No additional reporting requirements exist except as provided in other sections of this permit including Section B (Title V General Requirements) and/or Section E (Source Group Restrictions).

VI. WORK PRACTICE REQUIREMENTS.

No additional work practice requirements exist except as provided in other sections of this permit including Section B (Title V General Requirements) and/or Section E (Source Group Restrictions).

VII. ADDITIONAL REQUIREMENTS.

No additional requirements exist except as provided in other sections of this permit including Section B (Title V General Requirements) and/or Section E (Source Group Restrictions).

***** Permit Shield in Effect. *****

**SECTION D. Source Level Requirements**

Source ID: 505

Source Name: A-3 SMALL PARTS CASTING (FUGITIVE/UNCONTROL)

Source Capacity/Throughput: 500.000 Each/HR STORAGE BATTERIES

Conditions for this source occur in the following groups: SG 03 A-3 BATTERY ASSEMBLY

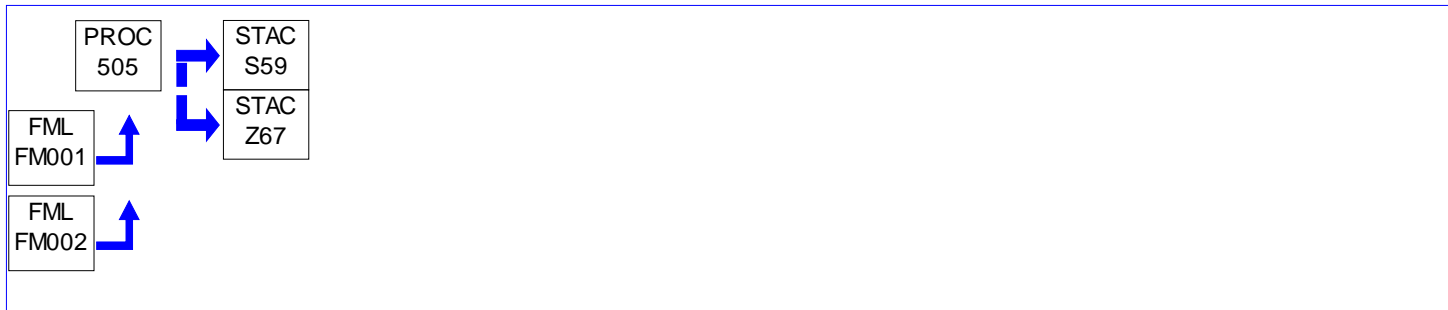
**I. RESTRICTIONS.**

No additional requirements exist except as provided in other sections of this permit including Section B (Title V General Requirements) and/or Section E (Source Group Restrictions).

II. TESTING REQUIREMENTS.

No additional testing requirements exist except as provided in other sections of this permit including Section B (Title V General Requirements) and/or Section E (Source Group Restrictions).

III. MONITORING REQUIREMENTS.

No additional monitoring requirements exist except as provided in other sections of this permit including Section B (Title V General Requirements) and/or Section E (Source Group Restrictions).

IV. RECORDKEEPING REQUIREMENTS.

No additional record keeping requirements exist except as provided in other sections of this permit including Section B (Title V General Requirements) and/or Section E (Source Group Restrictions).

V. REPORTING REQUIREMENTS.

No additional reporting requirements exist except as provided in other sections of this permit including Section B (Title V General Requirements) and/or Section E (Source Group Restrictions).

VI. WORK PRACTICE REQUIREMENTS.

No additional work practice requirements exist except as provided in other sections of this permit including Section B (Title V General Requirements) and/or Section E (Source Group Restrictions).

VII. ADDITIONAL REQUIREMENTS.

No additional requirements exist except as provided in other sections of this permit including Section B (Title V General Requirements) and/or Section E (Source Group Restrictions).

***** Permit Shield in Effect. *****

**SECTION D. Source Level Requirements**

Source ID: 506

Source Name: SMALL PARTS CASTING & HYDRACAST

Source Capacity/Throughput: 120.000 Each/HR BATTERYCELLS

Conditions for this source occur in the following groups: SG 04 IND BATTERY ASSEMBLY
SG12 BAGHOUSE CAM

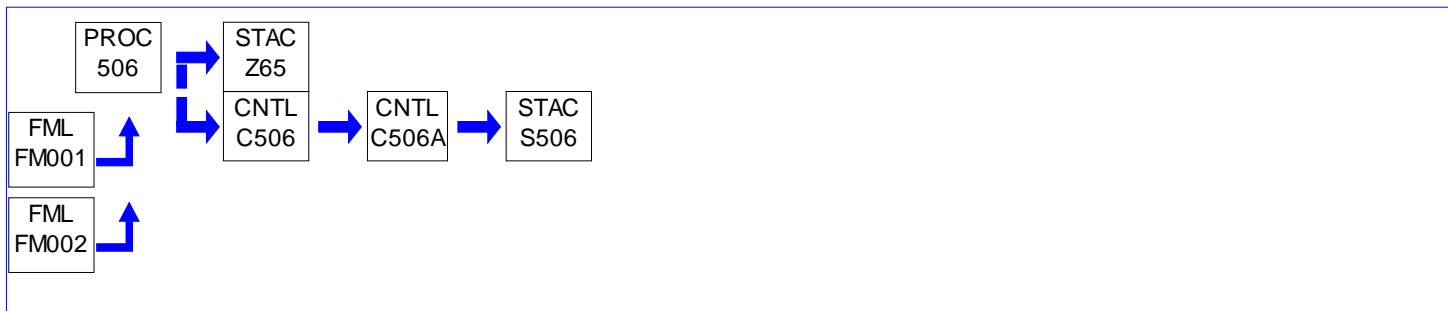
**I. RESTRICTIONS.**

No additional requirements exist except as provided in other sections of this permit including Section B (Title V General Requirements) and/or Section E (Source Group Restrictions).

II. TESTING REQUIREMENTS.

No additional testing requirements exist except as provided in other sections of this permit including Section B (Title V General Requirements) and/or Section E (Source Group Restrictions).

III. MONITORING REQUIREMENTS.

No additional monitoring requirements exist except as provided in other sections of this permit including Section B (Title V General Requirements) and/or Section E (Source Group Restrictions).

IV. RECORDKEEPING REQUIREMENTS.

No additional record keeping requirements exist except as provided in other sections of this permit including Section B (Title V General Requirements) and/or Section E (Source Group Restrictions).

V. REPORTING REQUIREMENTS.

No additional reporting requirements exist except as provided in other sections of this permit including Section B (Title V General Requirements) and/or Section E (Source Group Restrictions).

VI. WORK PRACTICE REQUIREMENTS.

No additional work practice requirements exist except as provided in other sections of this permit including Section B (Title V General Requirements) and/or Section E (Source Group Restrictions).

VII. ADDITIONAL REQUIREMENTS.

No additional requirements exist except as provided in other sections of this permit including Section B (Title V General Requirements) and/or Section E (Source Group Restrictions).

***** Permit Shield in Effect. *****

**SECTION D. Source Level Requirements**

Source ID: 507

Source Name: S-1 SMALL PART CASTING (FUGITIVE/UNCONT)

Source Capacity/Throughput: 300.000 Each/HR STORAGE BATTERIES

Conditions for this source occur in the following groups: SG 06 S-1 BATTERY ASSEMBLY

**I. RESTRICTIONS.**

No additional requirements exist except as provided in other sections of this permit including Section B (Title V General Requirements) and/or Section E (Source Group Restrictions).

II. TESTING REQUIREMENTS.

No additional testing requirements exist except as provided in other sections of this permit including Section B (Title V General Requirements) and/or Section E (Source Group Restrictions).

III. MONITORING REQUIREMENTS.

No additional monitoring requirements exist except as provided in other sections of this permit including Section B (Title V General Requirements) and/or Section E (Source Group Restrictions).

IV. RECORDKEEPING REQUIREMENTS.

No additional record keeping requirements exist except as provided in other sections of this permit including Section B (Title V General Requirements) and/or Section E (Source Group Restrictions).

V. REPORTING REQUIREMENTS.

No additional reporting requirements exist except as provided in other sections of this permit including Section B (Title V General Requirements) and/or Section E (Source Group Restrictions).

VI. WORK PRACTICE REQUIREMENTS.

No additional work practice requirements exist except as provided in other sections of this permit including Section B (Title V General Requirements) and/or Section E (Source Group Restrictions).

VII. ADDITIONAL REQUIREMENTS.

No additional requirements exist except as provided in other sections of this permit including Section B (Title V General Requirements) and/or Section E (Source Group Restrictions).

***** Permit Shield in Effect. *****

**SECTION D. Source Level Requirements**

Source ID: 508

Source Name: A-2 COS/ENVELOPE/CONCAST (SCIEN 10)

Source Capacity/Throughput:

Conditions for this source occur in the following groups: SG 02 A-2 BATTERY ASSEMBLY
 SG10B RACT 2
 SG12 BAGHOUSE CAM
 SG20 RACT III PRESUMPTIVE

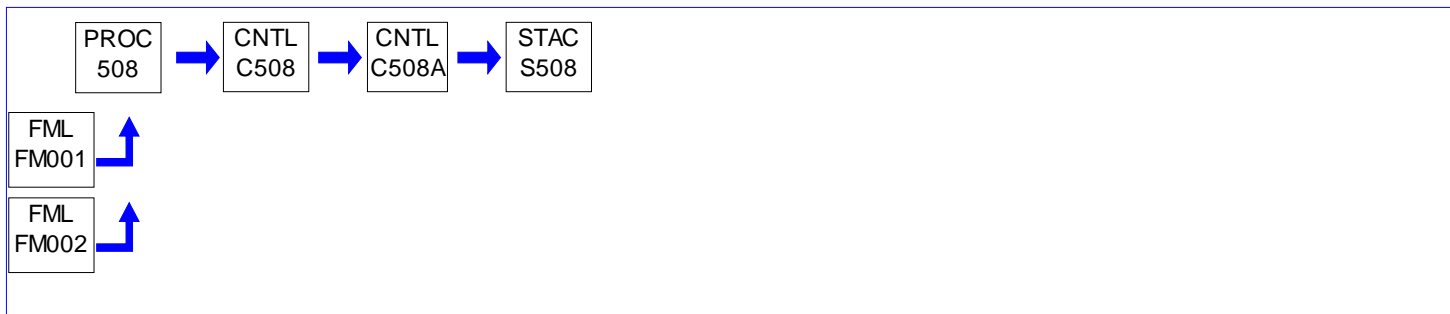
**I. RESTRICTIONS.**

No additional requirements exist except as provided in other sections of this permit including Section B (Title V General Requirements) and/or Section E (Source Group Restrictions).

II. TESTING REQUIREMENTS.

No additional testing requirements exist except as provided in other sections of this permit including Section B (Title V General Requirements) and/or Section E (Source Group Restrictions).

III. MONITORING REQUIREMENTS.

No additional monitoring requirements exist except as provided in other sections of this permit including Section B (Title V General Requirements) and/or Section E (Source Group Restrictions).

IV. RECORDKEEPING REQUIREMENTS.

No additional record keeping requirements exist except as provided in other sections of this permit including Section B (Title V General Requirements) and/or Section E (Source Group Restrictions).

V. REPORTING REQUIREMENTS.

No additional reporting requirements exist except as provided in other sections of this permit including Section B (Title V General Requirements) and/or Section E (Source Group Restrictions).

VI. WORK PRACTICE REQUIREMENTS.

No additional work practice requirements exist except as provided in other sections of this permit including Section B (Title V General Requirements) and/or Section E (Source Group Restrictions).

VII. ADDITIONAL REQUIREMENTS.

No additional requirements exist except as provided in other sections of this permit including Section B (Title V General Requirements) and/or Section E (Source Group Restrictions).

***** Permit Shield in Effect. *****

**SECTION D. Source Level Requirements**

Source ID: 511

Source Name: A-1 HEAT SEAL BOOTHS #1-4

Source Capacity/Throughput:

Conditions for this source occur in the following groups: SG 01 A-1 BATTERY ASSEMBLY
SG14 ABSOLENT CAM

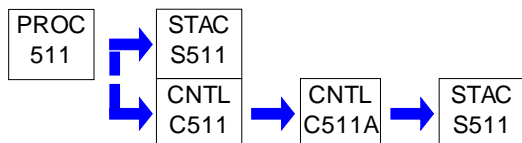
**I. RESTRICTIONS.**

No additional requirements exist except as provided in other sections of this permit including Section B (Title V General Requirements) and/or Section E (Source Group Restrictions).

II. TESTING REQUIREMENTS.

No additional testing requirements exist except as provided in other sections of this permit including Section B (Title V General Requirements) and/or Section E (Source Group Restrictions).

III. MONITORING REQUIREMENTS.

No additional monitoring requirements exist except as provided in other sections of this permit including Section B (Title V General Requirements) and/or Section E (Source Group Restrictions).

IV. RECORDKEEPING REQUIREMENTS.

No additional record keeping requirements exist except as provided in other sections of this permit including Section B (Title V General Requirements) and/or Section E (Source Group Restrictions).

V. REPORTING REQUIREMENTS.

No additional reporting requirements exist except as provided in other sections of this permit including Section B (Title V General Requirements) and/or Section E (Source Group Restrictions).

VI. WORK PRACTICE REQUIREMENTS.

No additional work practice requirements exist except as provided in other sections of this permit including Section B (Title V General Requirements) and/or Section E (Source Group Restrictions).

VII. ADDITIONAL REQUIREMENTS.

No additional requirements exist except as provided in other sections of this permit including Section B (Title V General Requirements) and/or Section E (Source Group Restrictions).

***** Permit Shield in Effect. *****

**SECTION D. Source Level Requirements**

Source ID: 512

Source Name: A-2 HEAT SEAL BOOTHS #1-9

Source Capacity/Throughput:

Conditions for this source occur in the following groups: SG 02 A-2 BATTERY ASSEMBLY

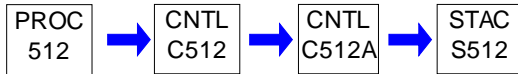
**I. RESTRICTIONS.**

No additional requirements exist except as provided in other sections of this permit including Section B (Title V General Requirements) and/or Section E (Source Group Restrictions).

II. TESTING REQUIREMENTS.

No additional testing requirements exist except as provided in other sections of this permit including Section B (Title V General Requirements) and/or Section E (Source Group Restrictions).

III. MONITORING REQUIREMENTS.

No additional monitoring requirements exist except as provided in other sections of this permit including Section B (Title V General Requirements) and/or Section E (Source Group Restrictions).

IV. RECORDKEEPING REQUIREMENTS.

No additional record keeping requirements exist except as provided in other sections of this permit including Section B (Title V General Requirements) and/or Section E (Source Group Restrictions).

V. REPORTING REQUIREMENTS.

No additional reporting requirements exist except as provided in other sections of this permit including Section B (Title V General Requirements) and/or Section E (Source Group Restrictions).

VI. WORK PRACTICE REQUIREMENTS.

No additional work practice requirements exist except as provided in other sections of this permit including Section B (Title V General Requirements) and/or Section E (Source Group Restrictions).

VII. ADDITIONAL REQUIREMENTS.

No additional requirements exist except as provided in other sections of this permit including Section B (Title V General Requirements) and/or Section E (Source Group Restrictions).

***** Permit Shield in Effect. *****

**SECTION D. Source Level Requirements**

Source ID: 513

Source Name: A-3 HEAT SEAL BOOTHS #1 - 3

Source Capacity/Throughput:

Conditions for this source occur in the following groups: SG 03 A-3 BATTERY ASSEMBLY
SG14 ABSOLENT CAM

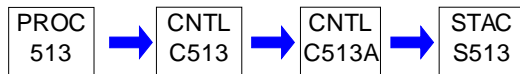
**I. RESTRICTIONS.**

No additional requirements exist except as provided in other sections of this permit including Section B (Title V General Requirements) and/or Section E (Source Group Restrictions).

II. TESTING REQUIREMENTS.

No additional testing requirements exist except as provided in other sections of this permit including Section B (Title V General Requirements) and/or Section E (Source Group Restrictions).

III. MONITORING REQUIREMENTS.

No additional monitoring requirements exist except as provided in other sections of this permit including Section B (Title V General Requirements) and/or Section E (Source Group Restrictions).

IV. RECORDKEEPING REQUIREMENTS.

No additional record keeping requirements exist except as provided in other sections of this permit including Section B (Title V General Requirements) and/or Section E (Source Group Restrictions).

V. REPORTING REQUIREMENTS.

No additional reporting requirements exist except as provided in other sections of this permit including Section B (Title V General Requirements) and/or Section E (Source Group Restrictions).

VI. WORK PRACTICE REQUIREMENTS.

No additional work practice requirements exist except as provided in other sections of this permit including Section B (Title V General Requirements) and/or Section E (Source Group Restrictions).

VII. ADDITIONAL REQUIREMENTS.

No additional requirements exist except as provided in other sections of this permit including Section B (Title V General Requirements) and/or Section E (Source Group Restrictions).

***** Permit Shield in Effect. *****

**SECTION D. Source Level Requirements**

Source ID: 514

Source Name: S-1 HEAT SEAL BOOTHS #1-3

Source Capacity/Throughput:

Conditions for this source occur in the following groups: SG 06 S-1 BATTERY ASSEMBLY
SG14 ABSOLENT CAM

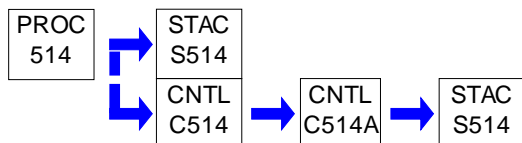
**I. RESTRICTIONS.**

No additional requirements exist except as provided in other sections of this permit including Section B (Title V General Requirements) and/or Section E (Source Group Restrictions).

II. TESTING REQUIREMENTS.

No additional testing requirements exist except as provided in other sections of this permit including Section B (Title V General Requirements) and/or Section E (Source Group Restrictions).

III. MONITORING REQUIREMENTS.

No additional monitoring requirements exist except as provided in other sections of this permit including Section B (Title V General Requirements) and/or Section E (Source Group Restrictions).

IV. RECORDKEEPING REQUIREMENTS.

No additional record keeping requirements exist except as provided in other sections of this permit including Section B (Title V General Requirements) and/or Section E (Source Group Restrictions).

V. REPORTING REQUIREMENTS.

No additional reporting requirements exist except as provided in other sections of this permit including Section B (Title V General Requirements) and/or Section E (Source Group Restrictions).

VI. WORK PRACTICE REQUIREMENTS.

No additional work practice requirements exist except as provided in other sections of this permit including Section B (Title V General Requirements) and/or Section E (Source Group Restrictions).

VII. ADDITIONAL REQUIREMENTS.

No additional requirements exist except as provided in other sections of this permit including Section B (Title V General Requirements) and/or Section E (Source Group Restrictions).

***** Permit Shield in Effect. *****

**SECTION D. Source Level Requirements**

Source ID: 515

Source Name: MOLDING LID SEAL BOOTHS 1-13: FIBER BEDS OR EQIV

Source Capacity/Throughput:

Conditions for this source occur in the following groups: SG14 ABSOLENT CAM

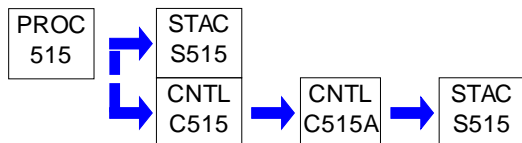
**I. RESTRICTIONS.****Emission Restriction(s).****# 001 [25 Pa. Code §127.441]****Operating permit terms and conditions.**

The permittee shall limit the particulate emissions from the sealing operation to:

- Uncontrolled Heat Sealing Operations - 0.02 grains per dry standard cubic foot
- Heat Sealing Operations Controlled by Absolent (or equivalent) Filter - 0.0075 grains per dry standard cubic foot

II. TESTING REQUIREMENTS.

No additional testing requirements exist except as provided in other sections of this permit including Section B (Title V General Requirements) and/or Section E (Source Group Restrictions).

III. MONITORING REQUIREMENTS.

No additional monitoring requirements exist except as provided in other sections of this permit including Section B (Title V General Requirements) and/or Section E (Source Group Restrictions).

IV. RECORDKEEPING REQUIREMENTS.**# 002 [25 Pa. Code §127.441]****Operating permit terms and conditions.**

The permittee shall maintain records of the monthly inspections of the filters including the results of the inspections and any actions.

V. REPORTING REQUIREMENTS.

No additional reporting requirements exist except as provided in other sections of this permit including Section B (Title V General Requirements) and/or Section E (Source Group Restrictions).

VI. WORK PRACTICE REQUIREMENTS.**# 003 [25 Pa. Code §127.441]****Operating permit terms and conditions.**

The permittee shall periodically conduct a visible inspection of each of the fiberglass filters. Any damaged or non-functioning filters shall be replaced. The frequency of these inspections shall be monthly, except as provided in the Section C 90% Monitoring Condition.

**SECTION D. Source Level Requirements****VII. ADDITIONAL REQUIREMENTS.****# 004 [25 Pa. Code §127.441]****Operating permit terms and conditions.**

The fiber bed method of control may be changed to an equivalent method upon receipt of written approval from the Department. The permittee may request such approval via an RFD. If the RFD is denied, the permittee must use a plan approval application to request the change.

***** Permit Shield in Effect. *****

**SECTION D. Source Level Requirements**

Source ID: 516

Source Name: A-4 HEAT & LID SEAL BOOTHS 1 - 14: FIBER BEDS OR EQIV CTRL

Source Capacity/Throughput:

Conditions for this source occur in the following groups: SG 08 A-4 BATTERY ASSEMBLY PLANT
SG14 ABSOLENT CAM

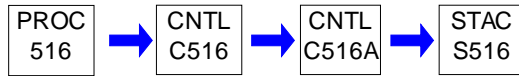
**I. RESTRICTIONS.**

No additional requirements exist except as provided in other sections of this permit including Section B (Title V General Requirements) and/or Section E (Source Group Restrictions).

II. TESTING REQUIREMENTS.

No additional testing requirements exist except as provided in other sections of this permit including Section B (Title V General Requirements) and/or Section E (Source Group Restrictions).

III. MONITORING REQUIREMENTS.

No additional monitoring requirements exist except as provided in other sections of this permit including Section B (Title V General Requirements) and/or Section E (Source Group Restrictions).

IV. RECORDKEEPING REQUIREMENTS.

No additional record keeping requirements exist except as provided in other sections of this permit including Section B (Title V General Requirements) and/or Section E (Source Group Restrictions).

V. REPORTING REQUIREMENTS.

No additional reporting requirements exist except as provided in other sections of this permit including Section B (Title V General Requirements) and/or Section E (Source Group Restrictions).

VI. WORK PRACTICE REQUIREMENTS.

No additional work practice requirements exist except as provided in other sections of this permit including Section B (Title V General Requirements) and/or Section E (Source Group Restrictions).

VII. ADDITIONAL REQUIREMENTS.**# 001 [25 Pa. Code §127.441]****Operating permit terms and conditions.**

The fiber bed method of control may be changed to an equivalent method upon receipt of written approval from the Department. The permittee may request such approval via an RFD. If the RFD is denied, the permittee must use a plan approval application to request the change.

***** Permit Shield in Effect. *****

**SECTION D. Source Level Requirements**

Source ID: 517

Source Name: SMELTER ANNEX LID SEALER BOOTHS #1-24

Source Capacity/Throughput:

Conditions for this source occur in the following groups: SG14 ABSOLENT CAM
SG19 SMELTER ANNEX

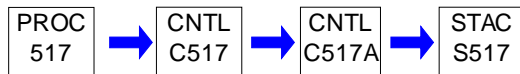
**I. RESTRICTIONS.****Emission Restriction(s).**

001 [25 Pa. Code §123.13]

Processes

For Source 517, the permittee shall limit the particulate emissions to the outdoor atmosphere to 0.0075 grain per dry standard cubic foot.

II. TESTING REQUIREMENTS.

No additional testing requirements exist except as provided in other sections of this permit including Section B (Title V General Requirements) and/or Section E (Source Group Restrictions).

III. MONITORING REQUIREMENTS.

No additional monitoring requirements exist except as provided in other sections of this permit including Section B (Title V General Requirements) and/or Section E (Source Group Restrictions).

IV. RECORDKEEPING REQUIREMENTS.

No additional record keeping requirements exist except as provided in other sections of this permit including Section B (Title V General Requirements) and/or Section E (Source Group Restrictions).

V. REPORTING REQUIREMENTS.

No additional reporting requirements exist except as provided in other sections of this permit including Section B (Title V General Requirements) and/or Section E (Source Group Restrictions).

VI. WORK PRACTICE REQUIREMENTS.

No additional work practice requirements exist except as provided in other sections of this permit including Section B (Title V General Requirements) and/or Section E (Source Group Restrictions).

VII. ADDITIONAL REQUIREMENTS.

No additional requirements exist except as provided in other sections of this permit including Section B (Title V General Requirements) and/or Section E (Source Group Restrictions).

***** Permit Shield in Effect. *****

**SECTION D. Source Level Requirements**

Source ID: 518

Source Name: IND HEAT SEAL BOOTHS #1 & #2

Source Capacity/Throughput:

Conditions for this source occur in the following groups: SG 04 IND BATTERY ASSEMBLY
SG14 ABSOLENT CAM

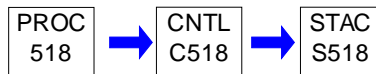
**I. RESTRICTIONS.**

No additional requirements exist except as provided in other sections of this permit including Section B (Title V General Requirements) and/or Section E (Source Group Restrictions).

II. TESTING REQUIREMENTS.

No additional testing requirements exist except as provided in other sections of this permit including Section B (Title V General Requirements) and/or Section E (Source Group Restrictions).

III. MONITORING REQUIREMENTS.

No additional monitoring requirements exist except as provided in other sections of this permit including Section B (Title V General Requirements) and/or Section E (Source Group Restrictions).

IV. RECORDKEEPING REQUIREMENTS.

No additional record keeping requirements exist except as provided in other sections of this permit including Section B (Title V General Requirements) and/or Section E (Source Group Restrictions).

V. REPORTING REQUIREMENTS.

No additional reporting requirements exist except as provided in other sections of this permit including Section B (Title V General Requirements) and/or Section E (Source Group Restrictions).

VI. WORK PRACTICE REQUIREMENTS.

No additional work practice requirements exist except as provided in other sections of this permit including Section B (Title V General Requirements) and/or Section E (Source Group Restrictions).

VII. ADDITIONAL REQUIREMENTS.

No additional requirements exist except as provided in other sections of this permit including Section B (Title V General Requirements) and/or Section E (Source Group Restrictions).

***** Permit Shield in Effect. *****

**SECTION D. Source Level Requirements**

Source ID: 601A

Source Name: EMERGENCY ENGINES PRE-2006

Source Capacity/Throughput:

Conditions for this source occur in the following groups: SG 09 SUBPART ZZZZ
 SG10B RACT 2
 SG20 RACT III PRESUMPTIVE

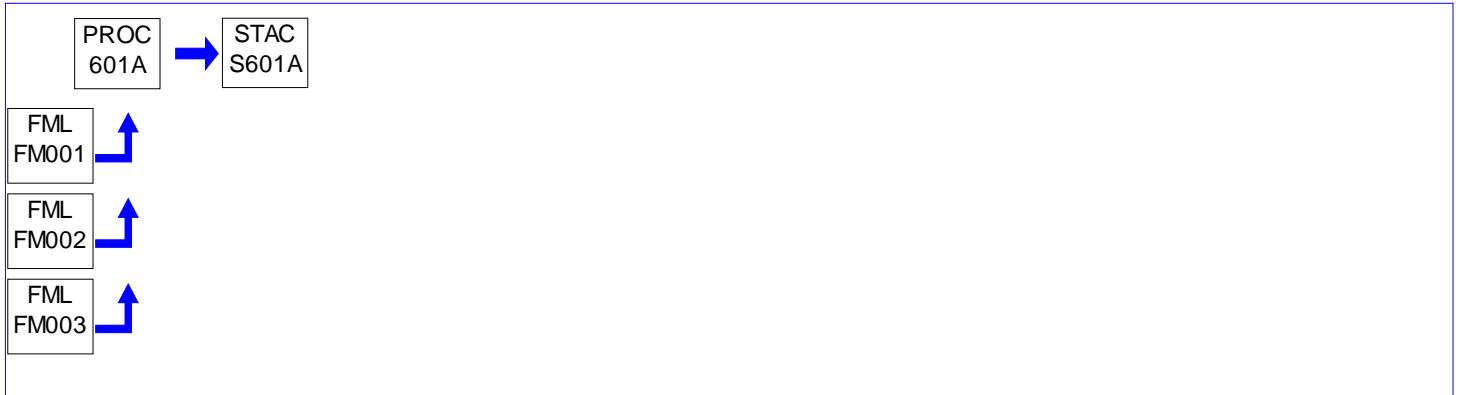
**I. RESTRICTIONS.****Emission Restriction(s).**
001 [25 Pa. Code §123.13]
Processes

The permittee shall limit the emissions of particulate matter to the outdoor atmosphere from each generator in a manner that the concentration of particulate matter in the effluent gas does not exceed 0.04 grain per dry standard cubic foot.

002 [25 Pa. Code §123.21]
General

No person may permit the emission into the outdoor atmosphere of sulfur oxides from a source in a manner that the concentration of the sulfur oxides, expressed as SO₂, in the effluent gas exceeds 500 parts per million, by volume, dry basis.

II. TESTING REQUIREMENTS.

No additional testing requirements exist except as provided in other sections of this permit including Section B (Title V General Requirements) and/or Section E (Source Group Restrictions).

III. MONITORING REQUIREMENTS.

No additional monitoring requirements exist except as provided in other sections of this permit including Section B (Title V General Requirements) and/or Section E (Source Group Restrictions).

IV. RECORDKEEPING REQUIREMENTS.
003 [25 Pa. Code §127.441]
Operating permit terms and conditions.

[Additional authority for parts of this condition are derived from 25 Pa Code Section 129.91]

The permittee shall maintain the following records for the emergency generators:

**SECTION D. Source Level Requirements**

- a. Monthly fuel consumption for each unit
- b. Type of fuel
- c. Heating value of each fuel (BTU)
- d. Hours of operation for each unit

V. REPORTING REQUIREMENTS.

No additional reporting requirements exist except as provided in other sections of this permit including Section B (Title V General Requirements) and/or Section E (Source Group Restrictions).

VI. WORK PRACTICE REQUIREMENTS.**# 004 [25 Pa. Code §127.441]****Operating permit terms and conditions.**

The emergency generators shall only be used during electrical failures or to perform preventative maintenance. The emergency generators shall not be used to supplement the primary power supply to the facility.

005 [25 Pa. Code §127.441]**Operating permit terms and conditions.**

[Additional authority for this condition is derived from 25 Pa Code Section 129.91]

The permittee shall limit the hours of operations for each emergency electrical generator to 500 hours in a consecutive 12-month period. The permittee shall maintain an hour meter, or use another method as approved by the Department, to measure and record the operating time of each emergency electrical generator.

VII. ADDITIONAL REQUIREMENTS.

No additional requirements exist except as provided in other sections of this permit including Section B (Title V General Requirements) and/or Section E (Source Group Restrictions).

***** Permit Shield in Effect. *****

**SECTION D. Source Level Requirements**

Source ID: 601B

Source Name: EMERGENCY SI ENGINES POST-2006

Source Capacity/Throughput:

Conditions for this source occur in the following groups: SG10B RACT 2
 SG15 SUBPART JJJJ
 SG20 RACT III PRESUMPTIVE

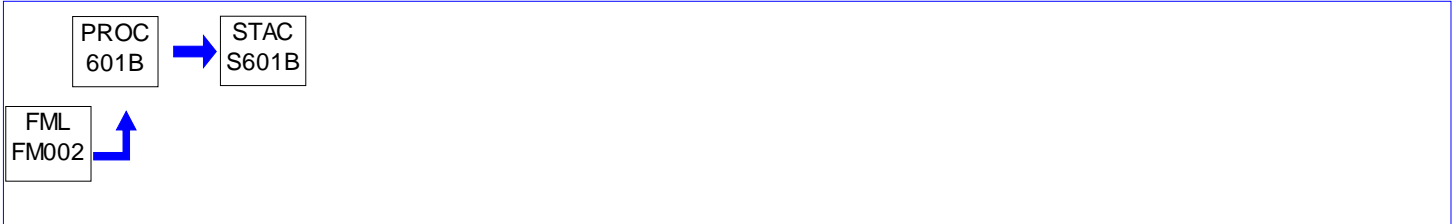
**I. RESTRICTIONS.****Emission Restriction(s).****# 001 [25 Pa. Code §123.13]****Processes**

The permittee shall not permit the emission to the atmosphere of particulate matter from a source in a manner that the concentration of particulate matter in the effluent gas exceeds 0.04 grain per dry standard cubic foot.

002 [25 Pa. Code §123.21]**General**

No person may permit the emission into the outdoor atmosphere of sulfur oxides from a source in a manner that the concentration of the sulfur oxides, expressed as SO₂, in the effluent gas exceeds 500 parts per million, by volume, dry basis.

II. TESTING REQUIREMENTS.

No additional testing requirements exist except as provided in other sections of this permit including Section B (Title V General Requirements) and/or Section E (Source Group Restrictions).

III. MONITORING REQUIREMENTS.

No additional monitoring requirements exist except as provided in other sections of this permit including Section B (Title V General Requirements) and/or Section E (Source Group Restrictions).

IV. RECORDKEEPING REQUIREMENTS.**# 003 [25 Pa. Code §127.441]****Operating permit terms and conditions.**

[Additional authority for parts of this condition are derived from 25 Pa Code Section 129.91]

The permittee shall maintain a monthly record of the hours of operation for each emergency generator to demonstrate compliance with Condition #004. The permittee shall maintain a monthly record of the fuel consumption by each emergency generator.

**SECTION D. Source Level Requirements****V. REPORTING REQUIREMENTS.**

No additional reporting requirements exist except as provided in other sections of this permit including Section B (Title V General Requirements) and/or Section E (Source Group Restrictions).

VI. WORK PRACTICE REQUIREMENTS.

004 [25 Pa. Code §127.441]

Operating permit terms and conditions.

[Additional authority for this condition is derived from 25 Pa Code Section 129.91]

The permittee shall limit the hours of operations for each emergency electrical generator to 500 hours in a consecutive 12-month period. The permittee shall maintain an hour meter, or use another method as approved by the Department, to measure and record the operating time of each emergency electrical generator.

005 [25 Pa. Code §127.441]

Operating permit terms and conditions.

Emergency generators shall only be used during electrical failures or to perform preventative maintenance. Emergency generators shall not be used to supplement the primary power supply to the facility.

VII. ADDITIONAL REQUIREMENTS.

No additional requirements exist except as provided in other sections of this permit including Section B (Title V General Requirements) and/or Section E (Source Group Restrictions).

***** Permit Shield in Effect. *****

**SECTION D. Source Level Requirements**

Source ID: 601C

Source Name: EMERGENCY CI ENGINES POST-2006

Source Capacity/Throughput:

Conditions for this source occur in the following groups: SG10B RACT 2
 SG16 SUBPART III
 SG20 RACT III PRESUMPTIVE

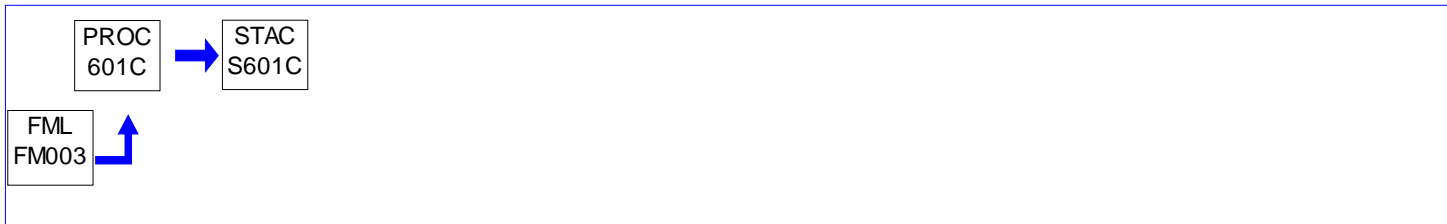
**I. RESTRICTIONS.****Emission Restriction(s).****# 001 [25 Pa. Code §123.13]****Processes**

The permittee shall not permit the emission to the atmosphere of particulate matter from a source in a manner that the concentration of particulate matter in the effluent gas exceeds 0.04 grain per dry standard cubic foot.

002 [25 Pa. Code §123.21]**General**

No person may permit the emission into the outdoor atmosphere of sulfur oxides from a source in a manner that the concentration of the sulfur oxides, expressed as SO₂, in the effluent gas exceeds 500 parts per million, by volume, dry basis.

II. TESTING REQUIREMENTS.

No additional testing requirements exist except as provided in other sections of this permit including Section B (Title V General Requirements) and/or Section E (Source Group Restrictions).

III. MONITORING REQUIREMENTS.

No additional monitoring requirements exist except as provided in other sections of this permit including Section B (Title V General Requirements) and/or Section E (Source Group Restrictions).

IV. RECORDKEEPING REQUIREMENTS.**# 003 [25 Pa. Code §127.441]****Operating permit terms and conditions.**

[Additional authority for parts of this condition are derived from 25 Pa Code Section 129.91]

The permittee shall maintain a monthly record of the hours of operation for each emergency generator to demonstrate compliance with Condition #004. The permittee shall maintain a monthly record of the fuel consumption by each emergency generator.



SECTION D. Source Level Requirements

V. REPORTING REQUIREMENTS.

No additional reporting requirements exist except as provided in other sections of this permit including Section B (Title V General Requirements) and/or Section E (Source Group Restrictions).

VI. WORK PRACTICE REQUIREMENTS.

**# 004 [25 Pa. Code §127.441]
Operating permit terms and conditions.**

[Additional authority for this condition is derived from 25 Pa Code Section 129.91]

The permittee shall limit the hours of operations for each emergency electrical generator to 500 hours in a consecutive 12-month period. The permittee shall maintain an hour meter, or use another method as approved by the Department, to measure and record the operating time of each emergency electrical generator.

**# 005 [25 Pa. Code §127.441]
Operating permit terms and conditions.**

Emergency generators shall only be used during electrical failures or to perform preventative maintenance. Emergency generators shall not be used to supplement the primary power supply to the facility.

VII. ADDITIONAL REQUIREMENTS.

No additional requirements exist except as provided in other sections of this permit including Section B (Title V General Requirements) and/or Section E (Source Group Restrictions).

***** Permit Shield in Effect. *****

**SECTION D. Source Level Requirements**

Source ID: 601D

Source Name: NON-EMERGENCY GENERATORS PRE-2006

Source Capacity/Throughput:

Conditions for this source occur in the following groups: SG20 RACT III PRESUMPTIVE
SG22 SUBPART ZZZZ

**I. RESTRICTIONS.**

No additional requirements exist except as provided in other sections of this permit including Section B (Title V General Requirements) and/or Section E (Source Group Restrictions).

II. TESTING REQUIREMENTS.

No additional testing requirements exist except as provided in other sections of this permit including Section B (Title V General Requirements) and/or Section E (Source Group Restrictions).

III. MONITORING REQUIREMENTS.

No additional monitoring requirements exist except as provided in other sections of this permit including Section B (Title V General Requirements) and/or Section E (Source Group Restrictions).

IV. RECORDKEEPING REQUIREMENTS.

No additional record keeping requirements exist except as provided in other sections of this permit including Section B (Title V General Requirements) and/or Section E (Source Group Restrictions).

V. REPORTING REQUIREMENTS.

No additional reporting requirements exist except as provided in other sections of this permit including Section B (Title V General Requirements) and/or Section E (Source Group Restrictions).

VI. WORK PRACTICE REQUIREMENTS.

No additional work practice requirements exist except as provided in other sections of this permit including Section B (Title V General Requirements) and/or Section E (Source Group Restrictions).

VII. ADDITIONAL REQUIREMENTS.

No additional requirements exist except as provided in other sections of this permit including Section B (Title V General Requirements) and/or Section E (Source Group Restrictions).

***** Permit Shield in Effect. *****

**SECTION D. Source Level Requirements**

Source ID: 602

Source Name: COLD CLEANERS

Source Capacity/Throughput:

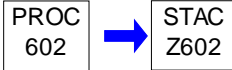
**I. RESTRICTIONS.****Emission Restriction(s).****# 001 [25 Pa. Code §129.63]****Degreasing operations**

The permittee shall not use in a cold cleaning machine that uses 2 gallons or more of solvents, any solvent with greater than 5% VOC by weight, and that has a vapor pressure of 1.0 millimeter of mercury (mm Hg) or greater measured at 20°C (68°F).

The above requirement does not apply:

- To cold cleaning machines used in extreme cleaning service.
- If the permittee demonstrates, and the Department approves in writing, that compliance with these conditions will result in unsafe operating conditions.
- To immersion cold cleaning machines with a freeboard ratio equal to or greater than 0.75.

002 [25 Pa. Code §129.63]**Degreasing operations**

Any immersion cold cleaning machine shall have a freeboard ratio of 0.50 or greater.

II. TESTING REQUIREMENTS.

No additional testing requirements exist except as provided in other sections of this permit including Section B (Title V General Requirements).

III. MONITORING REQUIREMENTS.

No additional monitoring requirements exist except as provided in other sections of this permit including Section B (Title V General Requirements).

IV. RECORDKEEPING REQUIREMENTS.**# 003 [25 Pa. Code §129.63]****Degreasing operations**

The permittee shall maintain an inventory of the cold cleaning machines used at the facility. The inventory shall be updated each January. The inventory shall include the following information:

- Type of unit
- Size of the unit in gallons of solvent
- Name of solvent used
- Freeboard ratio
- Location of the unit at the facility

The permittee shall maintain for at least two (2) years and shall provide to the Department, on request, the following

**SECTION D. Source Level Requirements**

information:

- a. The name and address of the solvent supplier.
- b. Type of solvent including the product or vendor identification number.
- c. The vapor pressure of the solvent measured in millimeters of mercury (mmHg) at 20°C (68°F).

An invoice, bill of sale, certificate that corresponds to a number of sales, Material Safety Data Sheet (MSDS), or other appropriate documentation acceptable to the Department may be used to comply with this section.

V. REPORTING REQUIREMENTS.

No additional reporting requirements exist except as provided in other sections of this permit including Section B (Title V General Requirements).

VI. WORK PRACTICE REQUIREMENTS.**# 004 [25 Pa. Code §129.63]****Degreasing operations**

The immersion cold cleaning machine shall be equipped with a cover that shall be closed at all times except during cleaning of parts or the addition or removal of solvent. For remote reservoir cold cleaning machines which drain directly into the solvent storage reservoir, a perforated drain with a diameter of not more than six (6) inches shall constitute an acceptable cover.

005 [25 Pa. Code §129.63]**Degreasing operations**

The permittee shall for immersion cold cleaning machines and remote reservoir cold cleaning machines:

a. Have a permanent, conspicuous label summarizing the operating requirements below:

1. Waste solvent shall be collected and stored in closed containers. The closed containers may contain a device that allows pressure relief, but does not allow liquid solvent to drain from the container.
2. Flushing of parts using a flexible hose or other flushing device shall be performed only within the cold cleaning machine. The solvent spray shall be a solid fluid stream, not an atomized or shower spray.
3. Sponge, fabric, wood, leather, paper products and other absorbent materials may not be cleaned in the cleaning machine.
4. Air agitated solvent baths may not be used.
5. Spills during solvent transfer and use of cold cleaning machines shall be cleaned-up immediately.

b. In addition, the label shall include the following discretionary good practices:

1. Cleaned parts should be drained at least 15 seconds or until dripping ceases, whichever is longer. Parts having cavities or blind holes shall be tipped or rotated while the part is draining. During the draining, tipping or rotating, the parts should be positioned so that the solvent drains directly back to the cold cleaning machine.
2. When a pump-agitated solvent bath is used, the agitator should be operated to produce a rolling motion of the solvent with no observable splashing of the solvent against the tank walls or the parts being cleaned.
3. Work area fans should be located and positioned so that they do not blow across the opening of the cold cleaning

**SECTION D. Source Level Requirements**

machine.

VII. ADDITIONAL REQUIREMENTS.

No additional requirements exist except as provided in other sections of this permit including Section B (Title V General Requirements).

***** Permit Shield in Effect. *****

**SECTION D. Source Level Requirements**

Source ID: 603

Source Name: SMALL PARTS COATING OPERATION

Source Capacity/Throughput:

Conditions for this source occur in the following groups: SG10B RACT 2
 SG18 SUBPART MMMM
 SG20 RACT III PRESUMPTIVE

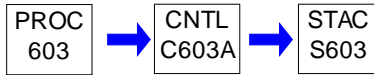
**I. RESTRICTIONS.**

No additional requirements exist except as provided in other sections of this permit including Section B (Title V General Requirements) and/or Section E (Source Group Restrictions).

II. TESTING REQUIREMENTS.

No additional testing requirements exist except as provided in other sections of this permit including Section B (Title V General Requirements) and/or Section E (Source Group Restrictions).

III. MONITORING REQUIREMENTS.

No additional monitoring requirements exist except as provided in other sections of this permit including Section B (Title V General Requirements) and/or Section E (Source Group Restrictions).

IV. RECORDKEEPING REQUIREMENTS.

No additional record keeping requirements exist except as provided in other sections of this permit including Section B (Title V General Requirements) and/or Section E (Source Group Restrictions).

V. REPORTING REQUIREMENTS.

No additional reporting requirements exist except as provided in other sections of this permit including Section B (Title V General Requirements) and/or Section E (Source Group Restrictions).

VI. WORK PRACTICE REQUIREMENTS.

No additional work practice requirements exist except as provided in other sections of this permit including Section B (Title V General Requirements) and/or Section E (Source Group Restrictions).

VII. ADDITIONAL REQUIREMENTS.

No additional requirements exist except as provided in other sections of this permit including Section B (Title V General Requirements) and/or Section E (Source Group Restrictions).

***** Permit Shield in Effect. *****

**SECTION D. Source Level Requirements**

Source ID: 604

Source Name: IND BATTERY TOUCH-UP OPERATION

Source Capacity/Throughput:

Conditions for this source occur in the following groups: SG10B RACT 2
 SG18 SUBPART MMMM
 SG20 RACT III PRESUMPTIVE

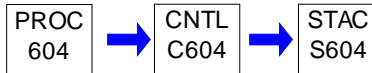
**I. RESTRICTIONS.****Emission Restriction(s).****# 001 [25 Pa. Code §123.13]****Processes**

The permittee shall not permit the emission to the atmosphere of particulate matter from either source in a manner that the concentration of particulate matter in the effluent gas exceeds 0.04 grain per dry standard cubic foot.

II. TESTING REQUIREMENTS.

No additional testing requirements exist except as provided in other sections of this permit including Section B (Title V General Requirements) and/or Section E (Source Group Restrictions).

III. MONITORING REQUIREMENTS.

No additional monitoring requirements exist except as provided in other sections of this permit including Section B (Title V General Requirements) and/or Section E (Source Group Restrictions).

IV. RECORDKEEPING REQUIREMENTS.**# 002 [25 Pa. Code §127.441]****Operating permit terms and conditions.**

The permittee shall record the following information for waste coatings, solvents or mixtures sent off-site for recycling or disposal:

- Pounds and gallons per month of waste coating, solvents or mixtures shipped from the facility,
- Waste profile or sampling data for each shipment, and
- Identification of the waste disposal company for each shipment.

V. REPORTING REQUIREMENTS.

No additional reporting requirements exist except as provided in other sections of this permit including Section B (Title V General Requirements) and/or Section E (Source Group Restrictions).

VI. WORK PRACTICE REQUIREMENTS.

No additional work practice requirements exist except as provided in other sections of this permit including Section B (Title V General Requirements) and/or Section E (Source Group Restrictions).

**SECTION D. Source Level Requirements****VII. ADDITIONAL REQUIREMENTS.**

No additional requirements exist except as provided in other sections of this permit including Section B (Title V General Requirements) and/or Section E (Source Group Restrictions).

***** Permit Shield in Effect. *****

**SECTION D. Source Level Requirements**

Source ID: 604B

Source Name: IND BATTERY TOUCH-UP OPERATION (POST-2012)

Source Capacity/Throughput:

Conditions for this source occur in the following groups: SG18 SUBPART MMMM
SG20 RACT III PRESUMPTIVE

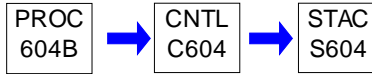
**I. RESTRICTIONS.****Emission Restriction(s).****# 001 [25 Pa. Code §127.441]****Operating permit terms and conditions.**

The permittee shall limit the emissions of VOCs to the outdoor atmosphere from Source 604B to 2.7 tons during any consecutive 12-month period.

II. TESTING REQUIREMENTS.

No additional testing requirements exist except as provided in other sections of this permit including Section B (Title V General Requirements) and/or Section E (Source Group Restrictions).

III. MONITORING REQUIREMENTS.

No additional monitoring requirements exist except as provided in other sections of this permit including Section B (Title V General Requirements) and/or Section E (Source Group Restrictions).

IV. RECORDKEEPING REQUIREMENTS.**# 002 [25 Pa. Code §127.441]****Operating permit terms and conditions.**

The permittee shall maintain the necessary information required to determine the monthly emissions of VOCs from Source 604B. These monthly VOC emissions shall also be maintained on a 12-month rolling total basis.

V. REPORTING REQUIREMENTS.

No additional reporting requirements exist except as provided in other sections of this permit including Section B (Title V General Requirements) and/or Section E (Source Group Restrictions).

VI. WORK PRACTICE REQUIREMENTS.

No additional work practice requirements exist except as provided in other sections of this permit including Section B (Title V General Requirements) and/or Section E (Source Group Restrictions).

VII. ADDITIONAL REQUIREMENTS.

No additional requirements exist except as provided in other sections of this permit including Section B (Title V General Requirements) and/or Section E (Source Group Restrictions).

***** Permit Shield in Effect. *****

**SECTION D. Source Level Requirements**

Source ID: 605

Source Name: BATTERY FINISHING

Source Capacity/Throughput:

Conditions for this source occur in the following groups: SG10C RACT 2
SG21 RACT III CBC

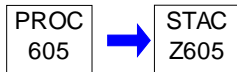
**I. RESTRICTIONS.****Emission Restriction(s).****# 001 [25 Pa. Code §127.441]****Operating permit terms and conditions.**

The permittee shall limit the emissions of VOCs to the outdoor atmosphere from Source 605 to 15.0 tons during any consecutive 12-month period.

II. TESTING REQUIREMENTS.

No additional testing requirements exist except as provided in other sections of this permit including Section B (Title V General Requirements) and/or Section E (Source Group Restrictions).

III. MONITORING REQUIREMENTS.

No additional monitoring requirements exist except as provided in other sections of this permit including Section B (Title V General Requirements) and/or Section E (Source Group Restrictions).

IV. RECORDKEEPING REQUIREMENTS.**# 002 [25 Pa. Code §127.441]****Operating permit terms and conditions.**

The permittee shall maintain the necessary information required to determine the monthly emissions of VOCs from Source 605. These monthly VOC emissions shall also be maintained on a 12-month rolling total basis.

V. REPORTING REQUIREMENTS.

No additional reporting requirements exist except as provided in other sections of this permit including Section B (Title V General Requirements) and/or Section E (Source Group Restrictions).

VI. WORK PRACTICE REQUIREMENTS.

No additional work practice requirements exist except as provided in other sections of this permit including Section B (Title V General Requirements) and/or Section E (Source Group Restrictions).

VII. ADDITIONAL REQUIREMENTS.

No additional requirements exist except as provided in other sections of this permit including Section B (Title V General Requirements) and/or Section E (Source Group Restrictions).

***** Permit Shield in Effect. *****

**SECTION D. Source Level Requirements**

Source ID: 608

Source Name: GASOLINE AND DIESEL HANDLING

Source Capacity/Throughput:

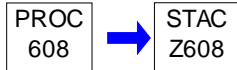
**I. RESTRICTIONS.**

No additional requirements exist except as provided in other sections of this permit including Section B (Title V General Requirements).

II. TESTING REQUIREMENTS.

No additional testing requirements exist except as provided in other sections of this permit including Section B (Title V General Requirements).

III. MONITORING REQUIREMENTS.

No additional monitoring requirements exist except as provided in other sections of this permit including Section B (Title V General Requirements).

IV. RECORDKEEPING REQUIREMENTS.

No additional record keeping requirements exist except as provided in other sections of this permit including Section B (Title V General Requirements).

V. REPORTING REQUIREMENTS.

No additional reporting requirements exist except as provided in other sections of this permit including Section B (Title V General Requirements).

VI. WORK PRACTICE REQUIREMENTS.**# 001 [25 Pa. Code §129.61]****Small gasoline storage tank control (Stage 1 control)**

(a) Applicability. This section applies Statewide to the owner and operator of a gasoline storage tank with a capacity of greater than 2,000 gallons.

(b) Transfer requirements. A person may not transfer gasoline from a gasoline tank truck into a gasoline storage tank at a gasoline dispensing facility unless the displaced vapors from the storage tank are transferred to the dispensing tank of the gasoline tank truck through a vapor tight return line and unless the gasoline dispensing facility storage tank is equipped with a submerged fill pipe which extends from the filling orifice to within 6 inches of the bottom of the storage tank.

(c) Gasoline tank truck dispensing tank requirements. The dispensing tank of a gasoline tank truck must remain vapor tight at all times, except that the dispensing tank may be opened after the vapors are disposed of under § 129.59 or § 129.60(c).

(d) [NA - NOT SUBJECT TO §129.61a]

VII. ADDITIONAL REQUIREMENTS.

No additional requirements exist except as provided in other sections of this permit including Section B (Title V General Requirements).

***** Permit Shield in Effect. *****

**SECTION D. Source Level Requirements**

Source ID: 699

Source Name: 5D SOURCES

Source Capacity/Throughput:

Conditions for this source occur in the following groups: SG10B RACT 2

SG11

SG20 RACT III PRESUMPTIVE

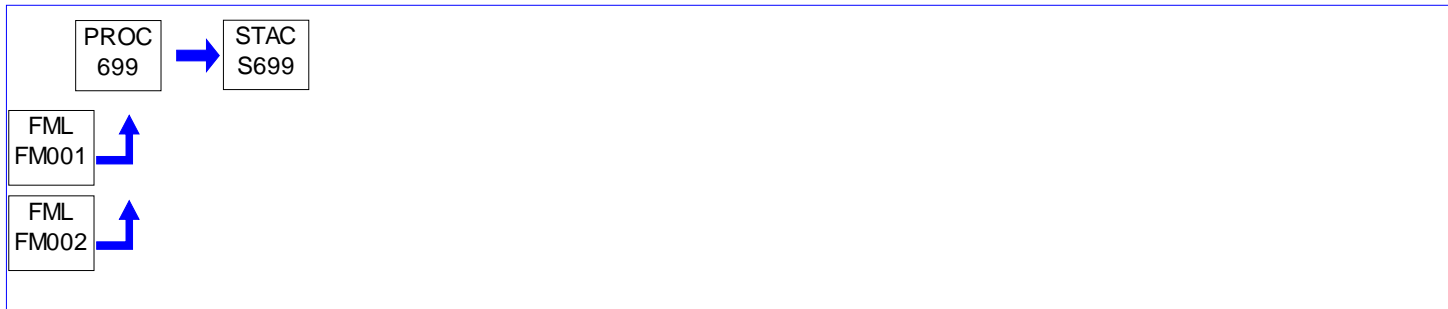
**I. RESTRICTIONS.**

No additional requirements exist except as provided in other sections of this permit including Section B (Title V General Requirements) and/or Section E (Source Group Restrictions).

II. TESTING REQUIREMENTS.

No additional testing requirements exist except as provided in other sections of this permit including Section B (Title V General Requirements) and/or Section E (Source Group Restrictions).

III. MONITORING REQUIREMENTS.

No additional monitoring requirements exist except as provided in other sections of this permit including Section B (Title V General Requirements) and/or Section E (Source Group Restrictions).

IV. RECORDKEEPING REQUIREMENTS.

No additional record keeping requirements exist except as provided in other sections of this permit including Section B (Title V General Requirements) and/or Section E (Source Group Restrictions).

V. REPORTING REQUIREMENTS.

No additional reporting requirements exist except as provided in other sections of this permit including Section B (Title V General Requirements) and/or Section E (Source Group Restrictions).

VI. WORK PRACTICE REQUIREMENTS.

No additional work practice requirements exist except as provided in other sections of this permit including Section B (Title V General Requirements) and/or Section E (Source Group Restrictions).

VII. ADDITIONAL REQUIREMENTS.

No additional requirements exist except as provided in other sections of this permit including Section B (Title V General Requirements) and/or Section E (Source Group Restrictions).

***** Permit Shield in Effect. *****

**SECTION D. Source Level Requirements**

Source ID: 700

Source Name: MISC COMBUSTION SOURCES (NOT 5D, NOT EMERGENCY GEN)

Source Capacity/Throughput:

Conditions for this source occur in the following groups: SG10B RACT 2
SG20 RACT III PRESUMPTIVE

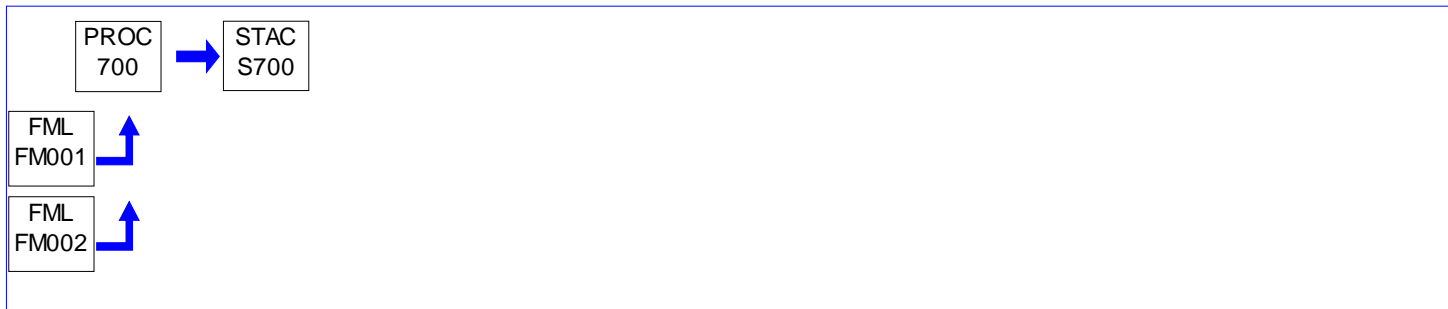
**I. RESTRICTIONS.**

No additional requirements exist except as provided in other sections of this permit including Section B (Title V General Requirements) and/or Section E (Source Group Restrictions).

II. TESTING REQUIREMENTS.

No additional testing requirements exist except as provided in other sections of this permit including Section B (Title V General Requirements) and/or Section E (Source Group Restrictions).

III. MONITORING REQUIREMENTS.

No additional monitoring requirements exist except as provided in other sections of this permit including Section B (Title V General Requirements) and/or Section E (Source Group Restrictions).

IV. RECORDKEEPING REQUIREMENTS.

No additional record keeping requirements exist except as provided in other sections of this permit including Section B (Title V General Requirements) and/or Section E (Source Group Restrictions).

V. REPORTING REQUIREMENTS.

No additional reporting requirements exist except as provided in other sections of this permit including Section B (Title V General Requirements) and/or Section E (Source Group Restrictions).

VI. WORK PRACTICE REQUIREMENTS.

No additional work practice requirements exist except as provided in other sections of this permit including Section B (Title V General Requirements) and/or Section E (Source Group Restrictions).

VII. ADDITIONAL REQUIREMENTS.

No additional requirements exist except as provided in other sections of this permit including Section B (Title V General Requirements) and/or Section E (Source Group Restrictions).

***** Permit Shield in Effect. *****

**SECTION D. Source Level Requirements**

Source ID: 718

Source Name: IND BATT FORMATION FOR A-3 (6 MIST ELIM)

Source Capacity/Throughput:

Conditions for this source occur in the following groups: SG 04 IND BATTERY ASSEMBLY
SG17 MIST ELIMINATOR CAM

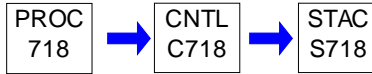
**I. RESTRICTIONS.**

No additional requirements exist except as provided in other sections of this permit including Section B (Title V General Requirements) and/or Section E (Source Group Restrictions).

II. TESTING REQUIREMENTS.

No additional testing requirements exist except as provided in other sections of this permit including Section B (Title V General Requirements) and/or Section E (Source Group Restrictions).

III. MONITORING REQUIREMENTS.

No additional monitoring requirements exist except as provided in other sections of this permit including Section B (Title V General Requirements) and/or Section E (Source Group Restrictions).

IV. RECORDKEEPING REQUIREMENTS.

No additional record keeping requirements exist except as provided in other sections of this permit including Section B (Title V General Requirements) and/or Section E (Source Group Restrictions).

V. REPORTING REQUIREMENTS.

No additional reporting requirements exist except as provided in other sections of this permit including Section B (Title V General Requirements) and/or Section E (Source Group Restrictions).

VI. WORK PRACTICE REQUIREMENTS.

No additional work practice requirements exist except as provided in other sections of this permit including Section B (Title V General Requirements) and/or Section E (Source Group Restrictions).

VII. ADDITIONAL REQUIREMENTS.

No additional requirements exist except as provided in other sections of this permit including Section B (Title V General Requirements) and/or Section E (Source Group Restrictions).

***** Permit Shield in Effect. *****

**SECTION D. Source Level Requirements**

Source ID: 719

Source Name: IND BATT FINISHING FOR A-3 (2 LINES)

Source Capacity/Throughput:

Conditions for this source occur in the following groups: SG21 RACT III CBC

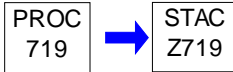
**I. RESTRICTIONS.****Emission Restriction(s).****# 001 [25 Pa. Code §127.441]****Operating permit terms and conditions.**

[Additional authority for this condition is derived from Plan Approval 06-05069Z]

The permittee shall limit the emissions of VOCs to the outdoor atmosphere from Source 719 to 5.93 tons during any consecutive 12-month period.

II. TESTING REQUIREMENTS.

No additional testing requirements exist except as provided in other sections of this permit including Section B (Title V General Requirements) and/or Section E (Source Group Restrictions).

III. MONITORING REQUIREMENTS.

No additional monitoring requirements exist except as provided in other sections of this permit including Section B (Title V General Requirements) and/or Section E (Source Group Restrictions).

IV. RECORDKEEPING REQUIREMENTS.**# 002 [25 Pa. Code §127.441]****Operating permit terms and conditions.**

[Additional authority for this condition is derived from Plan Approval 06-05069Z]

The permittee shall maintain the necessary information required to determine the monthly emissions of VOCs from Source 719. These monthly VOC emissions shall also be maintained in a 12-month rolling total.

003 [25 Pa. Code §127.441]**Operating permit terms and conditions.**

[Additional authority for this condition is derived from Plan Approval 06-05069Z]

Manufacturer supplied Certification Product Data Sheets (CPDS) and/or Material Safety Data Sheets (MSDS) for all solvents used on the Source 719 finishing lines within the most recent five years shall be maintained at this facility and be made available to the Department at any time.

004 [25 Pa. Code §127.441]**Operating permit terms and conditions.**

[Additional authority for this condition is derived from Plan Approval 06-05069Z]

The permittee shall record the quantity and identity of all VOC solvents used in the finishing operation of Source 719 on a monthly basis. These records shall be maintained and shall be made part of the permittee's annual "AIMS" report to the Department.

**SECTION D. Source Level Requirements****V. REPORTING REQUIREMENTS.**

No additional reporting requirements exist except as provided in other sections of this permit including Section B (Title V General Requirements) and/or Section E (Source Group Restrictions).

VI. WORK PRACTICE REQUIREMENTS.

005 [25 Pa. Code §127.441]

Operating permit terms and conditions.

[Additional authority for this condition is derived from Plan Approval 06-05069Z]

The permittee shall limit the VOC emissions from the finishing operation part of Source 719 finishing lines in the following manner:

- a. All solvents shall be stored in plunger cans or equivalent.
- b. All rags containing solvent shall be placed into storage containers (triangular red cans or others approved by the Department) for storage.
- c. All rags containing solvents shall be placed into sealed Haz-Waste drums and removed from the facility as part of disposal.

VII. ADDITIONAL REQUIREMENTS.

No additional requirements exist except as provided in other sections of this permit including Section B (Title V General Requirements) and/or Section E (Source Group Restrictions).

***** Permit Shield in Effect. *****

**SECTION D. Source Level Requirements**

Source ID: 720

Source Name: IND ULTRA BATTERY OPERATIONS

Source Capacity/Throughput:

Conditions for this source occur in the following groups: SG 04 IND BATTERY ASSEMBLY
SG12 BAGHOUSE CAM

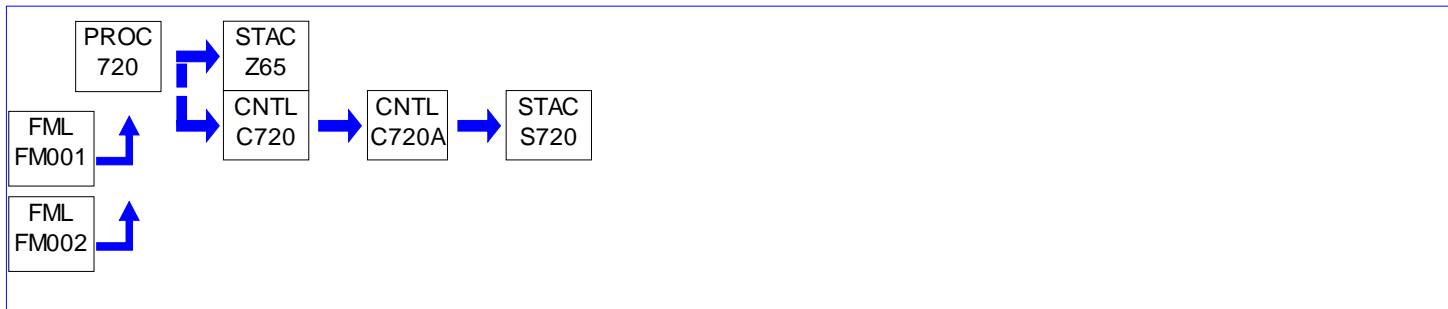
**I. RESTRICTIONS.**

No additional requirements exist except as provided in other sections of this permit including Section B (Title V General Requirements) and/or Section E (Source Group Restrictions).

II. TESTING REQUIREMENTS.

No additional testing requirements exist except as provided in other sections of this permit including Section B (Title V General Requirements) and/or Section E (Source Group Restrictions).

III. MONITORING REQUIREMENTS.

No additional monitoring requirements exist except as provided in other sections of this permit including Section B (Title V General Requirements) and/or Section E (Source Group Restrictions).

IV. RECORDKEEPING REQUIREMENTS.

No additional record keeping requirements exist except as provided in other sections of this permit including Section B (Title V General Requirements) and/or Section E (Source Group Restrictions).

V. REPORTING REQUIREMENTS.

No additional reporting requirements exist except as provided in other sections of this permit including Section B (Title V General Requirements) and/or Section E (Source Group Restrictions).

VI. WORK PRACTICE REQUIREMENTS.

No additional work practice requirements exist except as provided in other sections of this permit including Section B (Title V General Requirements) and/or Section E (Source Group Restrictions).

VII. ADDITIONAL REQUIREMENTS.

No additional requirements exist except as provided in other sections of this permit including Section B (Title V General Requirements) and/or Section E (Source Group Restrictions).

***** Permit Shield in Effect. *****

**SECTION D. Source Level Requirements**

Source ID: 721

Source Name: IND UNIGY II THREE-PROCESS-OPR

Source Capacity/Throughput:

Conditions for this source occur in the following groups: SG 04 IND BATTERY ASSEMBLY
SG12 BAGHOUSE CAM

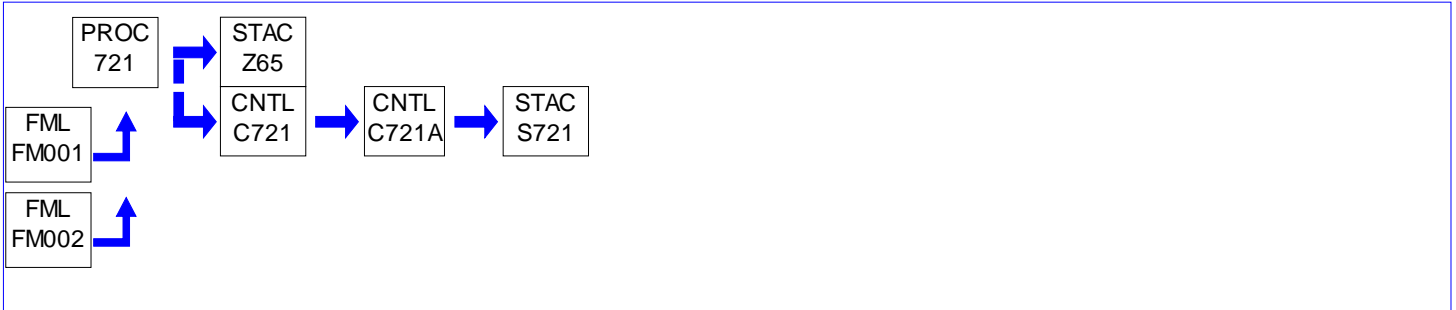
**I. RESTRICTIONS.**

No additional requirements exist except as provided in other sections of this permit including Section B (Title V General Requirements) and/or Section E (Source Group Restrictions).

II. TESTING REQUIREMENTS.

No additional testing requirements exist except as provided in other sections of this permit including Section B (Title V General Requirements) and/or Section E (Source Group Restrictions).

III. MONITORING REQUIREMENTS.

No additional monitoring requirements exist except as provided in other sections of this permit including Section B (Title V General Requirements) and/or Section E (Source Group Restrictions).

IV. RECORDKEEPING REQUIREMENTS.

No additional record keeping requirements exist except as provided in other sections of this permit including Section B (Title V General Requirements) and/or Section E (Source Group Restrictions).

V. REPORTING REQUIREMENTS.

No additional reporting requirements exist except as provided in other sections of this permit including Section B (Title V General Requirements) and/or Section E (Source Group Restrictions).

VI. WORK PRACTICE REQUIREMENTS.

No additional work practice requirements exist except as provided in other sections of this permit including Section B (Title V General Requirements) and/or Section E (Source Group Restrictions).

VII. ADDITIONAL REQUIREMENTS.

No additional requirements exist except as provided in other sections of this permit including Section B (Title V General Requirements) and/or Section E (Source Group Restrictions).

***** Permit Shield in Effect. *****

**SECTION D. Source Level Requirements**

Source ID: 722

Source Name: IND UNIGY II GRIDCASTING OPR

Source Capacity/Throughput:

Conditions for this source occur in the following groups: SG 04 IND BATTERY ASSEMBLY
SG12 BAGHOUSE CAM

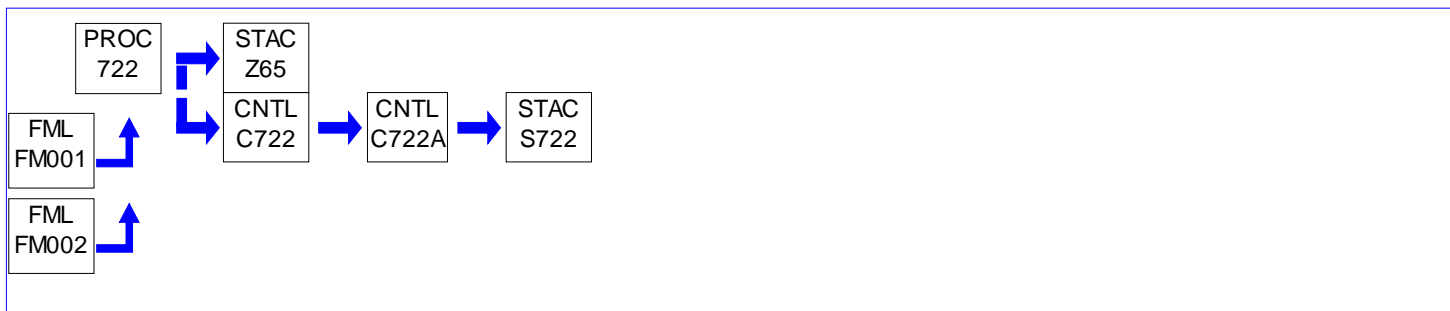
**I. RESTRICTIONS.**

No additional requirements exist except as provided in other sections of this permit including Section B (Title V General Requirements) and/or Section E (Source Group Restrictions).

II. TESTING REQUIREMENTS.

No additional testing requirements exist except as provided in other sections of this permit including Section B (Title V General Requirements) and/or Section E (Source Group Restrictions).

III. MONITORING REQUIREMENTS.

No additional monitoring requirements exist except as provided in other sections of this permit including Section B (Title V General Requirements) and/or Section E (Source Group Restrictions).

IV. RECORDKEEPING REQUIREMENTS.

No additional record keeping requirements exist except as provided in other sections of this permit including Section B (Title V General Requirements) and/or Section E (Source Group Restrictions).

V. REPORTING REQUIREMENTS.

No additional reporting requirements exist except as provided in other sections of this permit including Section B (Title V General Requirements) and/or Section E (Source Group Restrictions).

VI. WORK PRACTICE REQUIREMENTS.

No additional work practice requirements exist except as provided in other sections of this permit including Section B (Title V General Requirements) and/or Section E (Source Group Restrictions).

VII. ADDITIONAL REQUIREMENTS.

No additional requirements exist except as provided in other sections of this permit including Section B (Title V General Requirements) and/or Section E (Source Group Restrictions).

***** Permit Shield in Effect. *****

**SECTION D. Source Level Requirements**

Source ID: 724

Source Name: IND AUTO COS #3

Source Capacity/Throughput:

Conditions for this source occur in the following groups: SG 04 IND BATTERY ASSEMBLY
SG12 BAGHOUSE CAM

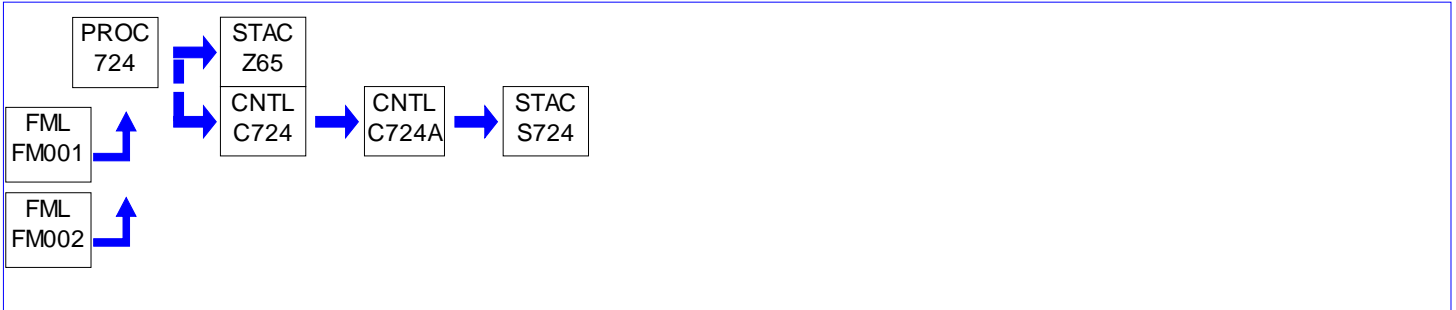
**I. RESTRICTIONS.**

No additional requirements exist except as provided in other sections of this permit including Section B (Title V General Requirements) and/or Section E (Source Group Restrictions).

II. TESTING REQUIREMENTS.

No additional testing requirements exist except as provided in other sections of this permit including Section B (Title V General Requirements) and/or Section E (Source Group Restrictions).

III. MONITORING REQUIREMENTS.

No additional monitoring requirements exist except as provided in other sections of this permit including Section B (Title V General Requirements) and/or Section E (Source Group Restrictions).

IV. RECORDKEEPING REQUIREMENTS.

No additional record keeping requirements exist except as provided in other sections of this permit including Section B (Title V General Requirements) and/or Section E (Source Group Restrictions).

V. REPORTING REQUIREMENTS.

No additional reporting requirements exist except as provided in other sections of this permit including Section B (Title V General Requirements) and/or Section E (Source Group Restrictions).

VI. WORK PRACTICE REQUIREMENTS.

No additional work practice requirements exist except as provided in other sections of this permit including Section B (Title V General Requirements) and/or Section E (Source Group Restrictions).

VII. ADDITIONAL REQUIREMENTS.

No additional requirements exist except as provided in other sections of this permit including Section B (Title V General Requirements) and/or Section E (Source Group Restrictions).

***** Permit Shield in Effect. *****

**SECTION D. Source Level Requirements**

Source ID: 725

Source Name: IND AUTO HEAT SEAL

Source Capacity/Throughput:

Conditions for this source occur in the following groups: SG 04 IND BATTERY ASSEMBLY
SG14 ABSOLENT CAM

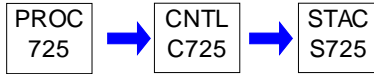
**I. RESTRICTIONS.**

No additional requirements exist except as provided in other sections of this permit including Section B (Title V General Requirements) and/or Section E (Source Group Restrictions).

II. TESTING REQUIREMENTS.

No additional testing requirements exist except as provided in other sections of this permit including Section B (Title V General Requirements) and/or Section E (Source Group Restrictions).

III. MONITORING REQUIREMENTS.

No additional monitoring requirements exist except as provided in other sections of this permit including Section B (Title V General Requirements) and/or Section E (Source Group Restrictions).

IV. RECORDKEEPING REQUIREMENTS.

No additional record keeping requirements exist except as provided in other sections of this permit including Section B (Title V General Requirements) and/or Section E (Source Group Restrictions).

V. REPORTING REQUIREMENTS.

No additional reporting requirements exist except as provided in other sections of this permit including Section B (Title V General Requirements) and/or Section E (Source Group Restrictions).

VI. WORK PRACTICE REQUIREMENTS.

No additional work practice requirements exist except as provided in other sections of this permit including Section B (Title V General Requirements) and/or Section E (Source Group Restrictions).

VII. ADDITIONAL REQUIREMENTS.

No additional requirements exist except as provided in other sections of this permit including Section B (Title V General Requirements) and/or Section E (Source Group Restrictions).

***** Permit Shield in Effect. *****

**SECTION D. Source Level Requirements**

Source ID: 726

Source Name: IND AUTO BATTERY FINISHING

Source Capacity/Throughput:

Conditions for this source occur in the following groups: SG 04 IND BATTERY ASSEMBLY

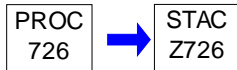
**I. RESTRICTIONS.**

No additional requirements exist except as provided in other sections of this permit including Section B (Title V General Requirements) and/or Section E (Source Group Restrictions).

II. TESTING REQUIREMENTS.

No additional testing requirements exist except as provided in other sections of this permit including Section B (Title V General Requirements) and/or Section E (Source Group Restrictions).

III. MONITORING REQUIREMENTS.

No additional monitoring requirements exist except as provided in other sections of this permit including Section B (Title V General Requirements) and/or Section E (Source Group Restrictions).

IV. RECORDKEEPING REQUIREMENTS.

No additional record keeping requirements exist except as provided in other sections of this permit including Section B (Title V General Requirements) and/or Section E (Source Group Restrictions).

V. REPORTING REQUIREMENTS.

No additional reporting requirements exist except as provided in other sections of this permit including Section B (Title V General Requirements) and/or Section E (Source Group Restrictions).

VI. WORK PRACTICE REQUIREMENTS.

No additional work practice requirements exist except as provided in other sections of this permit including Section B (Title V General Requirements) and/or Section E (Source Group Restrictions).

VII. ADDITIONAL REQUIREMENTS.**# 001 [25 Pa. Code §127.441]****Operating permit terms and conditions.**

The permittee shall record the quantity and identity of all VOC solvents used in the finishing operation of Source 726 on a monthly basis. These records shall be maintained and shall be made part of the permittee's annual "AIMS" report to the Department.

Manufacturer supplied Certification Product Data Sheets (CPDS) and/or Material Safety Data Sheets (MSDS) for all solvents used in the Source 726 finishing operation within the most recent five years shall be maintained at this facility and be made available to the Department at any time.

The permittee shall limit the VOC emissions from the Source 726 finishing operation in the following manner:

- All solvents shall be stored in plunger cans or equivalent.
- All rags containing solvent shall be placed into storage containers for storage.
- All rags containing solvents shall be placed into sealed Haz-Waste drums and removed from the facility as part of



SECTION D. Source Level Requirements

disposal.

***** Permit Shield in Effect. *****

**SECTION D. Source Level Requirements**

Source ID: 727

Source Name: IND AUTO BAT W/BATH FORM (2 MIST ELIMN)

Source Capacity/Throughput:

Conditions for this source occur in the following groups: SG 04 IND BATTERY ASSEMBLY
SG17 MIST ELIMINATOR CAM

**I. RESTRICTIONS.****Emission Restriction(s).****# 001 [25 Pa. Code §127.441]****Operating permit terms and conditions.**

The permittee shall limit the sulfuric acid mist (H₂SO₄) emissions to the outdoor atmosphere from the Source 727 to 0.001 grain per dry standard cubic foot as measured at each mist eliminator stack.

002 [25 Pa. Code §127.441]**Operating permit terms and conditions.**

The permittee shall operate Source 727 in a manner that results in no visible emissions to the outdoor atmosphere.

II. TESTING REQUIREMENTS.

No additional testing requirements exist except as provided in other sections of this permit including Section B (Title V General Requirements) and/or Section E (Source Group Restrictions).

III. MONITORING REQUIREMENTS.**# 003 [25 Pa. Code §127.441]****Operating permit terms and conditions.**

The permittee shall conduct the following monitoring schedule on each sulfuric acid mist control device in this group:

- Periodically read and record the pressure drop across each mist eliminator while the sources are in operation. The frequency of these readings shall be weekly, except as provided in the Section C 90% Monitoring Condition.
- Periodically read and record the visible emissions from each mist eliminator while the sources are in operation. The frequency of these readings shall be weekly, except as provided in the Section C 90% Monitoring Condition.
- Periodically conduct visual inspections of each mist eliminator. The frequency of these inspections shall be weekly, except as provided in the Section C 90% Monitoring Condition.
- Ensure that the mist eliminator pads are rinsed in accordance with manufacturer recommendations.

The permittee shall record the results of each reading and inspection on the approved inspection sheets. Any corrective actions should also be recorded in this manner.



SECTION D. Source Level Requirements

IV. RECORDKEEPING REQUIREMENTS.

No additional record keeping requirements exist except as provided in other sections of this permit including Section B (Title V General Requirements) and/or Section E (Source Group Restrictions).

V. REPORTING REQUIREMENTS.

No additional reporting requirements exist except as provided in other sections of this permit including Section B (Title V General Requirements) and/or Section E (Source Group Restrictions).

VI. WORK PRACTICE REQUIREMENTS.

No additional work practice requirements exist except as provided in other sections of this permit including Section B (Title V General Requirements) and/or Section E (Source Group Restrictions).

VII. ADDITIONAL REQUIREMENTS.

No additional requirements exist except as provided in other sections of this permit including Section B (Title V General Requirements) and/or Section E (Source Group Restrictions).

***** Permit Shield in Effect. *****

**SECTION D. Source Level Requirements**

Source ID: 728

Source Name: EQUIPMENT DECONSTRUCTION BUILDING

Source Capacity/Throughput:

Conditions for this source occur in the following groups: SG12 BAGHOUSE CAM
SG19 SMELTER ANNEX

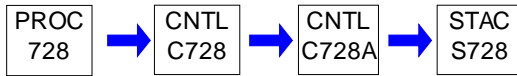
**I. RESTRICTIONS.****Emission Restriction(s).**

001 [25 Pa. Code §123.13]

Processes

For Source 728, the permittee shall limit the particulate emissions to the outdoor atmosphere to 0.001 grain per dry standard cubic foot.

II. TESTING REQUIREMENTS.

No additional testing requirements exist except as provided in other sections of this permit including Section B (Title V General Requirements) and/or Section E (Source Group Restrictions).

III. MONITORING REQUIREMENTS.

No additional monitoring requirements exist except as provided in other sections of this permit including Section B (Title V General Requirements) and/or Section E (Source Group Restrictions).

IV. RECORDKEEPING REQUIREMENTS.

No additional record keeping requirements exist except as provided in other sections of this permit including Section B (Title V General Requirements) and/or Section E (Source Group Restrictions).

V. REPORTING REQUIREMENTS.

No additional reporting requirements exist except as provided in other sections of this permit including Section B (Title V General Requirements) and/or Section E (Source Group Restrictions).

VI. WORK PRACTICE REQUIREMENTS.

No additional work practice requirements exist except as provided in other sections of this permit including Section B (Title V General Requirements) and/or Section E (Source Group Restrictions).

VII. ADDITIONAL REQUIREMENTS.

No additional requirements exist except as provided in other sections of this permit including Section B (Title V General Requirements) and/or Section E (Source Group Restrictions).

***** Permit Shield in Effect. *****

**SECTION E. Source Group Restrictions.**

Group Name: SG 01 A-1 BATTERY ASSEMBLY

Group Description: A-1 Battery Assembly Plant

Sources included in this group

ID	Name
111	A-1 MIXING (SCIEN FC 1) & PASTING (FARR CC 4)
112	A-1 DRY CHARGE AREA (SCIEN FC 7, SCIEN FC 6 & FARR CC 4)
113	A-1 GRIDCAST (SCIEN FC 6 & SCIEN FC 5)
114	A-1 BATTERY ASSM (FARR CC 4, SCIEN FC 6 & FC 7)
116A	A-1 LEAD OXIDE STORAGE SILOS (2) (BIN VENTS)
192	A-1 BURN & STACK (SCIENTIFIC FC 5)
504	A-1 SMALL PARTS CASTING (FUGITIVE/UNCONTROL)
511	A-1 HEAT SEAL BOOTHS #1-4

I. RESTRICTIONS.**Emission Restriction(s).****# 001 [25 Pa. Code §123.21]****General**

No person may permit the emission into the outdoor atmosphere of sulfur oxides from a source in this group in a manner that the concentration of the sulfur oxides, expressed as SO₂, in the effluent gas exceeds 500 parts per million, by volume, dry basis.

Note: This condition is not relevant to Source 511, so long as the source does not emit SO₂.

002 [25 Pa. Code §127.441]**Operating permit terms and conditions.**

[Additional authority for parts of this condition are derived from 25 Pa Code Section 123.13]

The permittee shall limit the particulate emissions to the outdoor atmosphere from these sources to the following as measured at the associated control device and/or stacks:

- a. Source 111 (A-1 Mixing: Scientific FC #1 & Pasting: Farr CC #4) - 0.001 grains per dry standard cubic foot (PA 1069M, 5069I & 5069J)
- b. Source 112 (A-1 Dry Change Area: Scientific FC #7, Scientific FC #6 & Farr CC #4)
 1. Scientific FC #6 & Farr CC #4 - 0.001 grains per dry standard cubic foot (PA 5069J)
 2. Scientific FC #7 - 0.001 grain per dry standard cubic foot (PA 06-05069R)
- c. Source 113 (A-1 Grid Cast: Scientific FC #5 & FC #6) - 0.001 grains per dry standard cubic foot (PA 5069J & 5069H)
- d. Source 114 (A-1 Battery Assembly: Farr CC #4 & Scientific FC #6 & FC #7) - 0.001 grains per dry standard cubic foot (PA 5069J)
- e. Source 116A (A-1 Lead Oxide Bins: Bin Vents) - 0.001 grains per dry standard cubic foot (RFD12/09)
- f. Source 192 (A-1 Burn & Stack: Scientific FC #5) - 0.001 grains per dry standard cubic foot (PA 5069J)
- g. Source 504 (A-1 Small Parts Casting) - 0.04 grains per standard cubic foot (123.13)
- k. Source 511 (A-1 Heat Seal Booths #1-4) - 0.02 grains per dry standard cubic foot (Appl)

**SECTION E. Source Group Restrictions.****# 003 [25 Pa. Code §127.441]****Operating permit terms and conditions.**

[Additional authority for parts of this condition is derived from 40 CFR Part 60, Subpart KK, NSPS]

The permittee shall limit the lead emissions to the outdoor atmosphere from these sources to the following as measured at the associated control devices and/or stacks:

- a. Source 111 (A-1 Mixing: Scientific FC #1 & Pasting Operation: Farr CC #4) - 0.0001 grains per dry standard cubic foot (PA 1069M, 5069I & 5069J)
- b. Source 112 (A-1 Dry Charge Area: Scientific FC #6, Farr CC #4 & Scientific FC #7)
 - 1. Scientific FC #6 & Farr CC #4 - 0.0001 grains per dry standard cubic foot (PA 5069J)
 - 2. Scientific FC #7 - 0.0001 grain per dry standard cubic foot (PA 06-05069R)
- c. Source 113 (A-1 Gridcast: Scientific FC #5 & FC #6) - 0.0001 grains per dry standard cubic foot (PA 5069J & 5069H)
- d. Source 114 (A-1 Battery Assembly: Farr CC #4 & Scientific FC #6 & FC #7) - 0.0001 grains per dry standard cubic foot (PA 1069M & 5069J)
- e. Source 116A (A-1 Lead Oxide Storage Silos: Bin Vents) - 0.0001 grains per dry standard cubic foot (RFD12/09)
- f. Source 192 (A-1 Burn & Stack: Scientific FC #5):0.0001 grains per dry standard cubic foot (PA 5069J)
- g. Source 504 (A-1 Small Parts Casting) - 0.000175 grains per dry standard cubic foot (PA 5069H)

004 [25 Pa. Code §127.441]**Operating permit terms and conditions.**

[Additional authority for this condition is derived from 40 CFR Part 60, Subpart KK, NSPS]

The permittee shall operate all of the sources except Source 511 (A-1 Heat Seal) in a manner that results in no visible emissions to the outdoor atmosphere.

Fuel Restriction(s).**# 005 [25 Pa. Code §127.441]****Operating permit terms and conditions.**

The permittee shall operate the sources in this source group using only natural gas and/or a propane-air mixture as a fuel.

II. TESTING REQUIREMENTS.

No additional testing requirements exist except as provided in other sections of this permit including Section B (Title V General Requirements).

III. MONITORING REQUIREMENTS.**# 006 [25 Pa. Code §127.441]****Operating permit terms and conditions.**

[Additional authority for parts of this condition is derived from 40 CFR Part 60, Subpart KK]

The permittee shall conduct the following monitoring schedule on each particulate, lead and/or sulfuric acid mist control device in this group, except Source 116A (A-1 Lead Oxide Storage Silos):

- a. Periodically read and record the pressure drop across each mist eliminator and each dust control device equipped with a

**SECTION E. Source Group Restrictions.**

HEPA filter and the HEPA filter, while the sources are in operation. The frequency of these readings shall be weekly, except as provided in the Section C 90% Monitoring Condition. For those dust collectors without a HEPA filter, these readings shall be daily, except as provided in the Section C 90% Monitoring Condition.

b. Periodically read and record the visible emissions from each mist eliminator and each dust control device equipped with a HEPA filter, while the sources are in operation. The frequency of these readings shall be weekly, except as provided in the Section C 90% Monitoring Condition. For those dust collectors without a HEPA filter, these readings shall be daily, except as provided in the Section C 90% Monitoring Condition.

c. Periodically conduct inspections of each control device and associated equipment, as appropriate, for:

1. Visually inspect the control device and associated equipment
2. Check for the proper removal of collected materials
3. Check for fugitive emissions from the control device

The frequency of these inspections shall be weekly, except as provided in the Section C 90% Monitoring Condition.

d. Ensure that the mist eliminator pads are rinsed in accordance with manufacturer recommendations.

e. Perform a semiannual inspection and maintenance of each fabric collector, HEPA filter and associated equipment. This includes the inspection and maintenance to ensure proper performance of each fabric collector and HEPA filter, including the structural and filter integrity of the collector.

The permittee shall record the results of each reading and inspection on the approved inspection sheets. Any corrective actions should also be recorded in this manner.

007 [25 Pa. Code §127.441]**Operating permit terms and conditions.**

The permittee shall inspect the Source 116 (A-1 Lead Oxide Storage Silo) as follows:

a. Annually, during a delivery:

- * The permittee shall read and record the visible emissions from each bin vent using Method 22.

b. Quarterly:

1. The pressure drop across the control devices shall be read, while the silos are being filled.
2. The control device and associated equipment shall be inspected, including structural and filter integrity.
3. The permittee shall check the bin vents to insure there is no excess buildup of material.
4. The source and control device shall be checked for fugitive emissions.

The permittee shall record the results of each reading and inspection on the approved inspection sheets. Any corrective actions shall also be recorded in this manner.

IV. RECORDKEEPING REQUIREMENTS.

No additional record keeping requirements exist except as provided in other sections of this permit including Section B (Title V General Requirements).

V. REPORTING REQUIREMENTS.

No additional reporting requirements exist except as provided in other sections of this permit including Section B (Title V General Requirements).

**SECTION E. Source Group Restrictions.****VI. WORK PRACTICE REQUIREMENTS.****# 008 [25 Pa. Code §127.441]****Operating permit terms and conditions.**

Equipment (a differential manometer or equivalent, as approved by the Department), shall be installed and maintained so that at any time the pressure drop across each fabric collector, mist eliminator and/or HEPA filter can be measured.

009 [25 Pa. Code §127.441]**Operating permit terms and conditions.**

The permittee shall exhaust the formation operations through mist eliminators.

VII. ADDITIONAL REQUIREMENTS.**# 010 [40 CFR Part 60 Standards of Performance for New Stationary Sources §40 CFR 60.370]****Subpart KK - Standards of Performance for Lead-Acid Battery Manufacturing Plants****Applicability and designation of affected facility.**

The sources listed below are subject to Subpart KK of the Standards of Performance for New Stationary Sources and shall comply with all applicable requirements of this Subpart. 40 CFR Section 60.4 requires submission of copies of all requests, reports, applications, submittals and other communications to both EPA and the Department.

The EPA copies shall be forwarded to:

Associate Director
United States Environmental Protection Agency
Region III, Enforcement & Compliance Assurance Division
Air, RCRA and Toxics Branch (3ED21)
Four Penn Center
1600 John F. Kennedy Boulevard
Philadelphia, Pennsylvania 19103-2852

Unless otherwise approved by DEP, the DEP copies shall be reported through the Department's Greenport PUP system available through: <https://greenport.pa.gov/ePermitPublicAccess/PublicSubmission/Home>

- a. Source 111 (A-1 Mixing: Scientific FC #1 and Pasting: Farr FC #4)
- b. Source 112 (A-1 Dry Charge: Scientific FC #2 and FC #6 & Farr CC #4)
- c. Source 113 (A-1 Gridcasting: Scientific FC #5 and FC #6)
- d. Source 114 (A-1 Battery Assembly: Scientific FC #6 and FC #7 & Farr CC #4)
- e. Source 116A (A-1 Lead Oxide Storage Silos: Bin Vents)
- f. Source 192 (A-1 Burn & Stack: Scientific FC #5)
- g. Source 504 (A-1 Small Parts Casting)

*** **Permit Shield in Effect.** ***

**SECTION E. Source Group Restrictions.**

Group Name: SG 02 A-2 BATTERY ASSEMBLY

Group Description: A-2 Battery Assembly Plant

Sources included in this group

ID	Name
130	A-2 BATTERY ASSEMBLY C (SCIENTIFIC FC 2)
131	A-2 MIXING (SCIEN FC 9) & PASTING (SCIEN FC 2 & 6)
132	A-2 COS & ENVELOPE (SCIEN FC 1 & SCIEN FC 10)
133	A-2 GRIDCAST (SCIEN FC 7, 2 & 10 & SCIEN FC 1)
133A	A-2 CONCASTER (SCIEN FC #1 & SCIEN FC #10)
133E	A-2 STRIP/PUNCHCAST MACH #1-3 (SCIEN FC 1)
134	A-2 ASSEMBLY (SCIENTIFIC FC 8)
136	A-2 LEAD OXIDE STORAGE SILOS (7) (BIN VENTS)
138	A-2 BATT ASMBLY (FARR CC 3)
139	A-2 BATTERY FORMATION (8 MIST ELIMN)
140	A-2 BATT ASMBLY D (FARR CC 4)
193	A-2 GROUP ASSEMBLY 1 (SCIENTIFIC FC 5)
194	A-2 GROUP ASSEMBLY 2 (SCIENTIFIC FC 6)
195	A-2 GROUP ASSEMBLY 3 (SCIENTIFIC FC 7)
502	A-2 SMALL PARTS CASTING (FUGITIVE/UNCONTROL)
503	A-2 RED LEAD OXIDE STORAGE SILO (BIN VENT)
508	A-2 COS/ENVELOPE/CONCAST (SCIEN 10)
512	A-2 HEAT SEAL BOOTHS #1-9

I. RESTRICTIONS.**Emission Restriction(s).****# 001 [25 Pa. Code §123.21]****General**

No person may permit the emission into the outdoor atmosphere of sulfur oxides from a source in this group in a manner that the concentration of the sulfur oxides, expressed as SO₂, in the effluent gas exceeds 500 parts per million, by volume, dry basis.

Note: This condition is not relevant to Sources 139 and 512 so long as these sources do not emit SO₂.

002 [25 Pa. Code §127.441]**Operating permit terms and conditions.**

The permittee shall limit the sulfuric acid mist (H₂SO₄) emissions to the outdoor atmosphere from Source 139 (A-2 Battery Formation) to 0.001 grains per dry standard cubic foot as measured at each mist eliminator stack. (PA 5069F)

003 [25 Pa. Code §127.441]**Operating permit terms and conditions.**

[Additional authority for parts of this condition are derived from 40 CFR Part 60, Subpart KK, NSPS]

The permittee shall operate all of the sources of SG02, except the concaster machines and Sources 139 and 512, in a manner that results in no visible emissions to the outdoor atmosphere.

The permittee shall limit the visible emissions from the concaster machines as follows:

- a. Lead pot - 0%
- b. Concasting operation:

**SECTION E. Source Group Restrictions.**

1. 20% or less for a period or periods aggregating more than 3 minutes in any one hour.
2. 60% or less at any time.

004 [25 Pa. Code §127.441]**Operating permit terms and conditions.**

[Additional authority for parts of this condition is derived from 25 Pa Code section 123.13]

The permittee shall limit the particulate emissions to the outdoor atmosphere from these source to the following as measured at the associated devices and/or stack:

- a. Source 130 (A-2 Battery Assembly: Scientific FC #2) - 0.001 grains per dry standard cubic foot (appl)
- b. Source 131 (A-2 Mixing & Pasting: Scientific FC #2, FC #6 & FC #9) - 0.001 grains per dry standard cubic foot (PA 1069M & 5069M)
- c. Source 132 (A-2 COS & Envelope: Carborundum FC #1 & Scientific FC #10) - 0.001 grains per dry standard cubic foot (Carborundum & Scientific) (PA 5069M)
- d. Source 133 (A-2 GRIDCAST (SCIEN FC 7, 2 & 10 & SCIEN FC 1)) - 0.001 grains per dry standard cubic foot (PA 5069B, 5069C, 5069E, 5069M, 5069N, 5069U & 5069X)
- e. Source 133A (A-2 Concaster [Lead Pots]: Carborundum FC #1 & Scientific FC #2) - 0.001 grains per dry standard cubic foot (PA 5069D, 5069F & 5069H)
- f. Source 133E (A-2 STRIP/PUNCHCAST MACH #1-3 (SCIEN FC 1)) - 0.001 grain per dry standard cubic foot (5069X)
- g. Source 134 (A-2 Battery Assembly A: Scientific FC #8) - 0.001 grains per dry standard cubic foot (appl)
- h. Source 136 (A-2 Lead Oxide Storage Silos: Bin Vents) - 0.001 grains per dry standard cubic foot (PA 5069J)
- i. Source 138 (A-2 Battery Assembly B: Farr FC #3) - 0.001 grains per dry standard cubic foot (PA 5069E)
- j. Source 140 (A-2 Battery Assembly D: Farr CC #4) - 0.001 grains per dry standard cubic foot (appl)
- k. Source 193 (A-2 Group Assembly #1: Scientific FC #5) - 0.001 grains per dry standard cubic foot (PA 1069M)
- l. Source 194 (A-2 Group Assembly #2: Scientific FC #6) - 0.001 grains per dry standard cubic foot (PA 1069M)
- m. Source 195 (A-2 Group Assembly #3: Scientific FC #7) - 0.001 grains per dry standard cubic foot (PA 5069M)
- n. Source 502 (A-2 Small Parts Casting) - 0.04 grains per dry standard cubic foot (123.13)
- o. Source 503 (A-2 Red Lead Oxide Storage Bin: Bin Vent) - 0.001 grains per dry standard cubic foot (PA 5069E)
- p. Source 512 (A-2 Heat Seal Booths #1-9) - 0.0075 grains per dry standard cubic foot (company)
- q. Source 508 (A-2 COS/ENVELOP/GRIDCAST: Scientific FC #10) - 0.001 grains per dry standard cubic foot (PA 5069M)

005 [25 Pa. Code §127.441]**Operating permit terms and conditions.**

[Additional authority for this condition is derived from 25 PA Section 129.91, RACT]

The permittee shall limit the volatile organic compound emissions to the outdoor atmosphere from the Source 133A (A-2 Concast) Caster Wheel to 0.02 grains per dry standard cubic foot as measured at the associated stack(s). (PA 5069B,

**SECTION E. Source Group Restrictions.**

5069F & 5069I)

006 [25 Pa. Code §127.441]**Operating permit terms and conditions.**

[Additional authority for parts of this condition are derived from 40 CFR Part 60, Subpart KK, NSPS]

The permittee shall limit the lead emissions to the outdoor atmosphere from these sources to the following as measured at the associated control device and/or stack:

- a. Source 130 (A-2 Battery Assembly C: Scientific FC #2) - 0.0001 grains per dry standard cubic foot (PA 1069H & 1069J)
- b. Source 131 (A-2 Mixing & Pasting: Scientific FC #2, #6 & #9) - 0.0001 grains per dry standard cubic foot (PA 1069M & 5069M)
- c. Source 132 (A-2 COS & Enveloping: Carborundum FC #1 & Scientific FC #10) - 0.0001 grains per dry standard cubic foot (PA 1069H, 1069J & 5069M)
- d. Source 133 (A-2 GRIDCAST (SCIEN FC 7, 2 & 10 & SCIEN FC 1)) - 0.0001 grains per dry standard cubic foot (PA 5069B, 5069C, 5069E, 5069M, 5069U & 5069X)
- e. Source 133A (A-2 Concast [Lead Pots]: Carborundum FC #1 & Scientific FC #2):
 - 1. Scientific FC #2 - 0.0001 grains per dry standard cubic foot (PA 5069D, 5069F, 5069H & 5069I)
 - 2. Carborundum FC #1 - 0.000344 grains per dry standard cubic foot (5069I)
- f. Source 133E (A-2 STRIP/PUNCHCAST MACH #1-3 (SCIEN FC 1)) - 0.0001 grain per dry standard cubic foot (5069X)
- g. Source 134 (A-2 Assembly A: Scientific FC #8) - 0.0001 grains per dry standard cubic foot (PA 1069J & 5069D)
- h. Source 136 (A-2 Lead Oxide Storage Silos) - 0.0001 grains per dry standard cubic foot (PA 5069B & 5069J)
- i. Source 138 (A-2 Battery Assembly B: Farr FC #3) - 0.0001 grains per dry standard cubic foot (PA 1069 H & 1069J)
- j. Source 140 (A-2 Battery Assembly D: Farr FC #4) - 0.0001 grains per dry standard cubic foot (PA 1069H & 1069J)
- k. Source 193 (A-2 Group Assembly #1: Scientific FC #5) - 0.0001 grains per dry standard cubic foot (PA 1069H, 1069J & 1069M)
- l. Source 194 (A-2 Group Assembly #2: Scientific FC #6) - 0.0001 grains per dry standard cubic foot (PA 1069H, 1069J & 1069M)
- m. Source 195 (A-2 Group Assembly #3: Scientific FC #7) - 0.0001 grains per dry standard cubic foot (PA 1069H, 1069J, 5069E & 5069M)
- n. Source 502 (A-2 Small Parts Casting) - 0.000437 grains per dry standard cubic foot (NSPS & PA 5069C)
- o. Source 503 (A-2 Red Lead Oxide Storage Bin) - 0.0001 grains per dry standard cubic foot (PA 5069E)
- p. Source 508 (A-2 COS/ENVELOP/GRIDCAST: Scientific FC #10) - 0.0001 grains per dry standard cubic foot (PA 5069M)

**SECTION E. Source Group Restrictions.****Fuel Restriction(s).****# 007 [25 Pa. Code §127.441]****Operating permit terms and conditions.**

The permittee shall operate the sources in this source group only on natural gas and/or a propane-air mixture as a fuel.

II. TESTING REQUIREMENTS.

No additional testing requirements exist except as provided in other sections of this permit including Section B (Title V General Requirements).

III. MONITORING REQUIREMENTS.**# 008 [25 Pa. Code §127.441]****Operating permit terms and conditions.**

[Additional authority for parts of this condition is derived from 40 CFR Part KK, NSPS]

The permittee shall conduct the following monitoring schedule on each particulate, lead and/or sulfuric acid mist control device in this group, except Source 136 (A-2 Lead Oxide Storage Silos) and Source 503 (A-2 Red Lead Oxide Storage Silo):

a. Periodically read and record the pressure drop across each control device equipped with a HEPA filter and the HEPA filter, while the sources are in operation. The frequency of these readings shall be weekly, except as provided in the Section C 90% Monitoring Condition. For those collectors without a HEPA filter, these readings shall be daily, except as provided in the Section C 90% Monitoring Condition.

b. Periodically read and record the visible emissions from each control device equipped with a HEPA filter, while the sources are in operation. The frequency of these readings shall be weekly, except as provided in the Section C 90% Monitoring Condition. For those collectors without a HEPA filter, these readings shall be daily, except as provided in the Section C 90% Monitoring Condition.

c. Periodically conduct inspections of each control device and associated equipment, as appropriate, for:

1. Visually inspect the control device and associated equipment
2. Check for the proper removal of collected materials
3. Check for fugitive emissions from the control device

The frequency of these inspections shall be weekly, except as provided in the Section C 90% Monitoring Condition.

d. Ensure that the mist eliminator pads are rinsed in accordance with manufacturer recommendations.

e. Perform a semiannual inspection and maintenance of each fabric collector, HEPA filter and associated equipment. This includes the inspection and maintenance to ensure proper performance of each fabric collector, including the structural and filter integrity of the collector.

The permittee shall record the results of each reading and inspection on the approved inspection sheets. Any corrective actions should also be recorded in this manner.

009 [25 Pa. Code §127.441]**Operating permit terms and conditions.**

The permittee shall inspect Source 136 (A-2 Lead Oxide Storage Silos) and Source 503 (A-2 Red Lead Oxide Storage Silo) as follows:

Annually, during a delivery:

The permittee shall read and record the visible emissions from the stack (S16) controlling the storage silos using US EPA Method 22.

**SECTION E. Source Group Restrictions.**

Quarterly:

- a. The pressure drop across the control devices and HEPA filter shall be read, while the silos are being filled.
- b. The control devices, HEPA filter and associated equipment shall be inspected including structural and filter integrity.
- c. The control device shall be checked to insure there is no excess buildup of materials.
- d. The source, control device and HEPA filter shall be checked for fugitive emissions.

The permittee shall record the results of each reading and inspection on the approved inspection sheets. Any corrective actions should also be recorded in this manner.

IV. RECORDKEEPING REQUIREMENTS.

No additional record keeping requirements exist except as provided in other sections of this permit including Section B (Title V General Requirements).

V. REPORTING REQUIREMENTS.

No additional reporting requirements exist except as provided in other sections of this permit including Section B (Title V General Requirements).

VI. WORK PRACTICE REQUIREMENTS.**# 010 [25 Pa. Code §127.441]****Operating permit terms and conditions.**

The permittee shall exhaust the formation operations through Department approved mist eliminators only.

011 [25 Pa. Code §127.441]**Operating permit terms and conditions.**

Equipment (a differential manometer or equivalent, as approved by the Department), shall be installed and maintained so that at any time the pressure drop across each fabric collector, mist eliminator and/or HEPA filter can be measured.

VII. ADDITIONAL REQUIREMENTS.**# 012 [40 CFR Part 60 Standards of Performance for New Stationary Sources §40 CFR 60.370]****Subpart KK - Standards of Performance for Lead-Acid Battery Manufacturing Plants****Applicability and designation of affected facility.**

The sources listed below are subject to Subpart KK of the Standards of Performance for New Stationary Sources and shall comply with all applicable requirements of this Subpart. 40 CFR Section 60.4 requires submission of copies of all requests, reports, applications, submittals and other communications to both EPA and the Department.

The EPA copies shall be forwarded to:

Associate Director
United States Environmental Protection Agency
Region III, Enforcement & Compliance Assurance Division
Air, RCRA and Toxics Branch (3ED21)
Four Penn Center
1600 John F. Kennedy Boulevard
Philadelphia, Pennsylvania 19103-2852

Unless otherwise approved by DEP, the DEP copies shall be reported through the Department's Greenport PUP system available through: <https://greenport.pa.gov/ePermitPublicAccess/PublicSubmission/Home>

- a. Source 130 (A-2 Battery Assembly C: Scientific FC #2)

**SECTION E. Source Group Restrictions.**

- b. Source 131 (A-2 Mixing & Pasting: Scientific FC #2, FC #6 & FC #9)
- c. Source 132 (A-2 COS & Envelope: Carborundum FC #1 & Scientific FC #10)
- d. Source 133 (A-2 Gridcast: Scientific FC #7, #2 & #10 & Carborundum FC #1)
- e. Source 133A (A-2 Concast: Carborundum FC #1 & Scientific FC #2) - Lead Pots only
- f. Source 133E (A-2 STRIP/PUNCHCAST MACH #1-3 Scientific FC #1)
- g. Source 134 (A-2 Battery Assembly A: Scientific FC #8)
- h. Source 136 (A-2 Lead Oxide Storage Bins: Bin Vents)
- i. Source 138 (A-2 Battery Assembly B: Farr FC #3)
- j. Source 140 (A-2 Battery Assembly D: Farr FC #4)
- k. Source 193 (A-2 Group Assembly #1: Scientific FC #5)
- l. Source 194 (A-2 Group Assembly No. 2: Scientific FC #6)
- m. Source 195 (A-2 Group Assembly No. 3: Scientific FC #7)
- n. Source 502 (A-2 Small Parts Casting)
- o. Source 503 (Red Lead Oxide Storage Bin: Bin Vent)
- p. Source 508 (A-2 COS/Envelop/Gridcast: Scientific FC #10)

***** Permit Shield in Effect. *****

**SECTION E. Source Group Restrictions.**

Group Name: SG 03 A-3 BATTERY ASSEMBLY

Group Description: A-3 Battery Assembly Plant

Sources included in this group

ID	Name
151	A-3 PASTE MIXING (SCIENTIFIC FC #6)
152	A-3 BATTERY ASSEMBLY (SCIENTIFIC CC #1)
153	A-3 COS & ENVELOPE A (SCIENTIFIC FC #2)
154	A-3 LEAD OXIDE STORAGE SILOS (3) (BIN VENTS)
156	A-3 GRIDCAST (SCIENTIFIC FC #6)
156A	A-3 CONCAST (SCIEN FC 6)
157	A-3 COS & ENVELOPE B (SCIENTIFIC FC #3)
158	A-3 COS & ENVELOPE D (SCIENTIFIC FC #4)
159	A-3 COS & STACKING C (SCIENTIFIC FC #5)
191	A-3- BATTERY FORMATION (9 MIST ELIM)
505	A-3 SMALL PARTS CASTING (FUGITIVE/UNCONTROL)
513	A-3 HEAT SEAL BOOTHS #1 - 3

I. RESTRICTIONS.**Emission Restriction(s).****# 001 [25 Pa. Code §123.21]****General**

No person may permit the emission into the outdoor atmosphere of sulfur oxides from a source in a manner that the concentration of the sulfur oxides, expressed as SO₂, in the effluent gas exceeds 500 parts per million, by volume, dry basis.

Note: This condition is not relevant to Sources 191 and 513 so long as these sources do not emit SO₂.

002 [25 Pa. Code §127.441]**Operating permit terms and conditions.**

[Additional authority for this condition is derived from 40 CFR Part 60, Subpart KK, NSPS]

The permittee shall operate all of the sources of SG03, subject to 40 CFR Part 60, Subpart KK, in a manner that results in no visible emissions to the outdoor atmosphere.

003 [25 Pa. Code §127.441]**Operating permit terms and conditions.**

[Additional authority for this condition is derived from 25 PA Section 129.91, RACT]

The permittee shall limit the volatile organic compound emissions to the outdoor atmosphere from Source 156A (A-3 Concast) Caster Wheel to 0.02 grains per dry standard cubic foot as measured at the associated stack(s). (PA 5069B)

004 [25 Pa. Code §127.441]**Operating permit terms and conditions.**

The permittee shall limit the sulfuric acid mist (H₂SO₄) emissions to the outdoor atmosphere from the Source 191 (A-3 Battery Formation) to 0.001 grains per dry standard cubic foot as measured at each mist eliminator stack. (PA 5069F)

005 [25 Pa. Code §127.441]**Operating permit terms and conditions.**

[Additional authority for parts of this condition are derived from 40 CFR Part 60, Subpart KK, NSPS]

**SECTION E. Source Group Restrictions.**

The permittee shall limit the lead emissions to the outdoor atmosphere from these sources to the following as measured at the associated control devices and/or stacks:

- a. Source 151 (A-3 Paste Mixing: Scientific FC #6) - 0.0001 grains per dry standard cubic foot (PA 5069I)
- b. Source 152 (A-3 Battery Assembly: Scientific CC #1) - 0.0001 grains per dry standard cubic foot (appl)
- c. Source 153 (A-3 COS & Enveloping A: Scientific FC #2 & #4) - 0.0001 grains per dry standard cubic foot (PA 5069I)
- d. Source 154 (A-3 Lead Oxide Bins: Bin Vents) - 0.0001 grains per dry standard cubic foot (RFD12/09)
- e. Source 156 (A-3 Gridcast: Scientific FC #6) - 0.0001 grains per dry standard cubic foot (PA 5069I)
- f. Source 156A (A-3 Concast [Lead Pots]: Scien FC #6) - 0.0001 grains per dry standard cubic foot (appl)
- g. Source 157 (A-3 COS & Envelope B: Scientific FC #3) - 0.0001 grains per dry standard cubic foot (appl)
- h. Source 158 (A-3 COS & Envelope D: Scientific CC #4) - 0.0001 grains per dry standard cubic foot (PA 5069I)
- i. Source 159 (A-3 COS & Stacking C: Scientific FC #5) - 0.0001 grains per dry standard cubic foot (appl)
- j. Source 505 (A-3 Small Parts Casting) - 0.000437 grains per dry standard cubic foot (NSPS)

006 [25 Pa. Code §127.441]**Operating permit terms and conditions.**

[Additional authority for parts of this condition are derived from 25 Pa Code Section 123.13]

The permittee shall limit the particulate emissions to the outdoor atmosphere from these sources to the following as measured at the associated control devices and/or stacks:

- a. Source 151 (A-3 Paste Mixing: Scientific FC #6) - 0.001 grains per dry standard cubic foot (PA 5069I)
- b. Source 152 (A-3 Battery Assembly: Scientific CC #1) - 0.001 grains per dry standard cubic foot (appl)
- c. Source 153 (A-3 COS & Envelope A: Scientific FC #2 & #4) - 0.001 grains per dry standard cubic foot (PA 5069I)
- d. Source 154 (A-3 Lead Oxide Storage Bins: Bin Vents) - 0.001 grains per dry standard cubic foot (RFD12/09)
- e. Source 156 (A-3 Grid Casting: Scientific FC #6) - 0.001 grains per dry standard cubic foot (PA 5069I)
- f. Source 156A (A-3 Concast [Lead Pots]: Scien FC #6) - 0.001 grains per dry standard cubic foot (appl)
- g. Source 157 (A-3 COS & Envelope B: Scientific FC #3) - 0.001 grains per dry standard cubic foot (appl)
- h. Source 158 (A-3 COS & Envelope D: Scientific CC #4) - 0.001 grains per dry standard cubic foot (PA 5069I)
- i. Source 159 (A-3 COS & Stacking C: Scientific FC #5) - 0.001 grains per dry standard cubic foot (appl)
- j. Source 505 (A-3 Small Parts Casting) - 0.04 grains per dry standard cubic foot (123.13)
- k. Source 513 (A-3 Heat Seal Booths #1-3) - 0.0075 grains per dry standard cubic foot (company)

**SECTION E. Source Group Restrictions.****Fuel Restriction(s).****# 007 [25 Pa. Code §127.441]****Operating permit terms and conditions.**

The permittee shall operate the source in this source group only on natural gas and/or a propane-air mixture as a fuel.

II. TESTING REQUIREMENTS.

No additional testing requirements exist except as provided in other sections of this permit including Section B (Title V General Requirements).

III. MONITORING REQUIREMENTS.**# 008 [25 Pa. Code §127.441]****Operating permit terms and conditions.**

[Additional authority for parts of this condition is derived from 40 CFR Part 60, Subpart KK, NSPS]

The permittee shall conduct the following monitoring schedule on each particulate, lead and/or sulfuric acid mist control device in this group, except the Source 154 (A-3 Lead Oxide Storage Silos):

- a. Periodically read and record the pressure drop across each control device and HEPA filter, while the sources are in operation. The frequency of these readings shall be weekly, except as provided in the Section C 90% Monitoring Condition.
- b. Periodically read and record the visible emissions from each source, while the source is in operation. The frequency of these readings shall be weekly, except as provided in the Section C 90% Monitoring Condition.
- c. Periodically conduct inspections of each control device, HEPA filter and associated equipment, as appropriate for:
 1. Visually inspect the control device and equipment
 2. Check for the proper removal collected materials
 3. Check for fugitive emissions from the control device

The frequency of these inspections shall be weekly, except as provided in the Section C 90% Monitoring Condition.

- d. Ensure that the mist eliminator pads are rinsed in accordance with manufacturer recommendations.
- e. Perform a semiannual inspection and maintenance of each fabric collector, HEPA filter and associated equipment. This includes the inspection and maintenance of each fabric collector and HEPA filter to ensure proper performance, including the structural and filter integrity of the collector.

The permittee shall record the results of each reading and inspection on the approved inspection sheets. Any corrective actions should also be recorded in this manner.

009 [25 Pa. Code §127.441]**Operating permit terms and conditions.**

The permittee shall inspect the Source 154 (A-3 Lead Oxide Storage Silos) as follows:

Annually, during a delivery:

The permittee shall read and record the visible emissions from each bin vent using US EPA Method 22.

Quarterly:

- a. The pressure drop across the control devices shall be read, while the silos are being filled.
- b. The control devices and associated equipment shall be inspected, including structural and filter integrity.

**SECTION E. Source Group Restrictions.**

c. The bin vents shall be checked to insure there is no excess buildup of materials.

d. The source and control device shall be checked for fugitive emissions.

The permittee shall record the results of each reading and inspection on the approved inspection sheets. Any corrective actions should also be recorded in this manner.

IV. RECORDKEEPING REQUIREMENTS.

No additional record keeping requirements exist except as provided in other sections of this permit including Section B (Title V General Requirements).

V. REPORTING REQUIREMENTS.

No additional reporting requirements exist except as provided in other sections of this permit including Section B (Title V General Requirements).

VI. WORK PRACTICE REQUIREMENTS.**# 010 [25 Pa. Code §127.441]****Operating permit terms and conditions.**

The permittee shall exhaust the formation operations through Department approved mist eliminators only.

011 [25 Pa. Code §127.441]**Operating permit terms and conditions.**

Equipment (a differential manometer or equivalent, as approved by the Department), shall be installed and maintained so that at any time the pressure drop across each fabric collector, mist eliminator and/or HEPA filter can be measured.

VII. ADDITIONAL REQUIREMENTS.**# 012 [40 CFR Part 60 Standards of Performance for New Stationary Sources §40 CFR 60.370]****Subpart KK - Standards of Performance for Lead-Acid Battery Manufacturing Plants****Applicability and designation of affected facility.**

The sources listed below are subject to Subpart KK of the Standards of Performance for New Stationary Sources and shall comply with all applicable requirements of this Subpart. 40 CFR Section 60.4 requires submission of copies of all requests, reports, applications, submittals and other communications to both EPA and the Department.

The EPA copies shall be forwarded to:

Associate Director
United States Environmental Protection Agency
Region III, Enforcement & Compliance Assurance Division
Air, RCRA and Toxics Branch (3ED21)
Four Penn Center
1600 John F. Kennedy Boulevard
Philadelphia, Pennsylvania 19103-2852

Unless otherwise approved by DEP, the DEP copies shall be reported through the Department's Greenport PUP system available through: <https://greenport.pa.gov/ePermitPublicAccess/PublicSubmission/Home>

- a. Source 151 (A-3 Paste Mixing: Scientific FC #6)
- b. Source 152 (A-3 Battery Assembly: Scientific FC #1)
- c. Source 153 (A-3 COS & Envelope: Scientific FC #2)
- d. Source 154 (A-3 Lead Oxide Storage Silos)
- e. Source 156 (A-3 Grid Casting: Scientific FC #6)
- f. Source 156A (A-3 Concast) - Lead Pots only
- g. Source 157 (A-3 COS & Envelope: Scientific FC #3)

**SECTION E. Source Group Restrictions.**

- h. Source 158 (A-3 Pasting: Scientific FC #4 & #6)
- i. Source 159 (A-3 COS & Stacking: Scientific FC #5)
- j. Source 505 (A-3 Small Parts Casting)

***** Permit Shield in Effect. *****

**SECTION E. Source Group Restrictions.**

Group Name: SG 04 IND BATTERY ASSEMBLY

Group Description: Industrial Battery Assembly Plant

Sources included in this group

ID	Name
135	IND LEAD OXIDE RECEIVING TANK (3) (BIN VENT)
141	IND HEATSEAL BOOTH (5)
143	IND GRIDCASTING (SCIEN #3)
144A	IND LEAD OXIDE STORAGE SILOS (6) (BIN VENTS)
146	IND MIX (SCIEN #2) & PASTE (CARB #1)
147	IND BATT ASSY/DRY CHARGE/FORM SUPP (SCIEN #4)
148	IND BATT ASSEMBLY (SCIEN #5)
149	IND FORMING ROOM & WET CHARGE (4 MIST ELIM)
150	IND BATTERY BOOST (4 MIST ELIM)
506	SMALL PARTS CASTING & HYDRACAST
518	IND HEAT SEAL BOOTHS #1 & #2
718	IND BATT FORMATION FOR A-3 (6 MIST ELIM)
720	IND ULTRA BATTERY OPERATIONS
721	IND UNIGY II THREE-PROCESS-OPR
722	IND UNIGY II GRIDCASTING OPR
724	IND AUTO COS #3
725	IND AUTO HEAT SEAL
726	IND AUTO BATTERY FINISHING
727	IND AUTO BAT W/BATH FORM (2 MIST ELIMN)

I. RESTRICTIONS.**Emission Restriction(s).****# 001 [25 Pa. Code §123.21]****General**

No person may permit the emission into the outdoor atmosphere of sulfur oxides from a source in a manner that the concentration of the sulfur oxides, expressed as SO₂, in the effluent gas exceeds 500 parts per million, by volume, dry basis.

Note: This condition is not relevant to Sources 135, 144A, 149, 150, 506, 518, 718, 725, 726, and 727 so long as these sources do not emit SO₂.

002 [25 Pa. Code §127.441]**Operating permit terms and conditions.**

The permittee shall limit the emissions of sulfuric acid mist (H₂SO₄) to the outdoor atmosphere from the Source 149 (Ind Forming Room), Source 150 (Ind Battery Boost) Source 718 (Ind Batt Formation for A-3 (6 Mist Elim)) and Source 727 (Ind Auto Bat) to 0.001 grains per dry standard cubic foot as measured at each mist eliminator stack. (PA 5069F & PA 0569AB)

003 [25 Pa. Code §127.441]**Operating permit terms and conditions.**

[Additional authority for parts of this condition are derived from 40 CFR Part 60, Subpart KK, NSPS]

The permittee shall operate all of the sources of SG04, subject to 40 CFR Part 60, Subpart KK, in a manner that results in no visible emissions to the outdoor atmosphere.

**SECTION E. Source Group Restrictions.****# 004 [25 Pa. Code §127.441]****Operating permit terms and conditions.**

[Additional authority for parts of this condition are derived from 25 Pa Code Section 123.13]

The permittee shall limit the emissions of particulate to the outdoor atmosphere from these sources to the following as measured at the associated control device and/or stack:

- a. Source 135 (Ind Lead Oxide Receiving Tank (3): Bin Vent) 0.001 grains per dry standard cubic foot (5069J)
- b. Source 141 (Ind Heatseal Booth (5)) 0.02 grain per dry standard cubic foot
- c. Source 143 (Ind Gridcasting (Scien #3)) - 0.001 grain per dry standard cubic foot (appl)
- d. Source 144A (Ind Lead Oxide Storage Silos (6): Bin Vents) - 0.001 grains per dry standard cubic foot (PA 5069D)
- e. Source 146 (Ind Mix: Scien #2) - 0.001 grains per dry standard cubic foot (appl)
- f. Source 146 (Ind Paste: Carb #1) - 0.001 grains per dry standard cubic foot (appl)
- g. Source 147 (Ind Battery Assembly/Dry Charge/Form Supp: Scien #4) - 0.001 grains per dry standard cubic foot (appl)
- h. Source 148 (Ind Battery Assembly: Scien #5) - 0.001 grains per dry standard cubic foot (PA 06-05069R)
- i. Source 506 (Ind Small Part Casting & Hydracast) - 0.001 grains per dry standard cubic foot (PA 06-05069R)
- j. Source 518 (Ind Heat Seal Booths #1-2) - 0.02 grains per dry standard cubic foot (company)
- k. Source 720 (Ind Ultra Battery Operations) - 0.001 grains per dry standard cubic foot (PA 06-05069AA)
- l. Source 721 (Ind Unigy II Three Process Operations) - 0.001 grains per dry standard cubic foot (PA 06-05069AA)
- m. Source 722 (Ind Unigy II Gridcasting Operations) - 0.001 grains per dry standard cubic foot (PA 06-05069AB)
- n. Source 724 (Ind Auto COS #3) - 0.001 grains per dry standard cubic foot (PA 06-05069AB)
- o. Source 725 (Ind Auto Heat Seal) - Controlled by Absolent (or equivalent) Filter - 0.0075 grains/dscf (PA 06-05069AB)

005 [40 CFR Part 60 Standards of Performance for New Stationary Sources §40 CFR 60.372]**Subpart KK - Standards of Performance for Lead-Acid Battery Manufacturing Plants
Standards for lead.**

[Additional authority for parts of this condition is derived from 25 Pa Code Section 127.1 and 40 CFR Part 60, Subpart KK, NSPS]

The permittee shall limit the lead emissions to the outdoor atmosphere from these sources to the following as measured at the associated control devices and/or stack:

- a. Source 135 (Ind Lead Oxide Receiving Tank (3): Bin Vent) - 0.0001 grains per dry standard cubic foot (5069J)
- b. Source 143 (Ind Gridcasting (Scien #3)) - 0.0001 grains per dry standard cubic foot (PA 06-05069AA)
- c. Source 144A (Ind Lead Oxide Storage Silos (6): Bin Vents) - 0.0001 grains per dry standard cubic foot (PA 5069D)
- d. Source 146 (Ind Mixing: Scien #2; Paste: Carb #1) - 0.0001 grains per dry standard cubic foot (PA 06-05069AA)

**SECTION E. Source Group Restrictions.**

- e. Source 147 (Ind Battery Assembly/Dry Charge/Form Supp: Scien #4) - 0.0001 grains per dry standard cubic foot (PA 06-05069AA)
- f. Source 148 (Ind Battery Assembly: Scien #5) - 0.0001 grain per dry standard cubic foot (PA 06-05069R)
- g. Source 506 (Ind Small Parts Casting & Hydracast) - 0.0001 grain per dry standard cubic foot (PA 06-05069R)
- h. Source 720 (Ind Ultra Battery Operations) - 0.0001 grain per dry standard cubic foot (PA 06-05069AA)
- i. Source 721 (Ind Unigy II Three-Process-Operations) - 0.0001 grain per dry standard cubic foot (PA 06-05069AA)
- j. Source 722 (Ind Unigy II Gridcasting Operations) - 0.0001 grains per dry standard cubic foot (PA 06-05069AB)
- k. Source 724 (Ind Auto COS #3) - 0.0001 grains per dry standard cubic foot (PA 06-05069AB)

Fuel Restriction(s).**# 006 [25 Pa. Code §127.441]****Operating permit terms and conditions.**

The permittee shall operate the sources in this source group only on natural gas and/or a propane-air mixture as a fuel.

II. TESTING REQUIREMENTS.

No additional testing requirements exist except as provided in other sections of this permit including Section B (Title V General Requirements).

III. MONITORING REQUIREMENTS.**# 007 [25 Pa. Code §127.441]****Operating permit terms and conditions.**

[Additional authority for this condition is derived from 40 CFR Part 60, Subpart KK, NSPS]

The permittee shall conduct the following monitoring schedule on each particulate, lead and/or sulfuric acid mist control device in this group, except the Source 144A (Ind Lead Oxide Storage Silos) and Source 135 (Ind Lead Oxide Receiving Bin) and Source 727 (Ind Auto Bat W/Bath Form (2 Mist Elim)):

- a. Periodically read and record the pressure drop across each control device equipped with a HEPA filter and the HEPA filter, while the sources are in operation. The frequency of these readings shall be weekly, except as provided in the Section C 90% Monitoring Condition. For those collectors without a HEPA filter, these readings shall be daily, except as provided in the Section C 90% Monitoring Condition.
- b. Periodically read and record the visible emissions from each control device equipped with a HEPA filter, while the sources are in operation. The frequency of these readings shall be weekly, except as provided in the Section C 90% Monitoring Condition. For those collectors without a HEPA filter, these readings shall be daily, except as provided in the Section C 90% Monitoring Condition.
- c. Periodically conduct inspections of each control device and associated equipment, as appropriate, for:
 - 1. Visually inspect the control device and associated equipment
 - 2. Check for the proper removal of collected materials
 - 3. Check for fugitive emissions from the control device

The frequency of these inspections shall be weekly, except as provided in the Section C 90% Monitoring Condition.

- d. Ensure that the mist eliminator pads are rinsed in accordance with manufacturer recommendations.

**SECTION E. Source Group Restrictions.**

e. Perform a semiannual inspection and maintenance of each fabric collector, HEPA filter and associated equipment. This includes the inspection and maintenance to ensure proper performance of each fabric collector and HEPA filter, including the structural and filter integrity of the collector.

The permittee shall record the results of each reading and inspection on the approved inspection sheets. Any corrective action should also be recorded in this manner.

008 [25 Pa. Code §127.441]**Operating permit terms and conditions.**

The permittee shall inspect the Source 144A (Ind Lead Oxide Storage Silos (2) Bin Vents) and Source 135 (Ind Lead Oxide Receiving Tank) as follows:

Annually, during a delivery:

The permittee shall read and record the visible emissions from each bin vent using US EPA Method 22.

Quarterly:

a. The Pressure drop across the control devices and HEPA shall be read, while the silos are being filled.

b. The control devices, HEPA filter and associated equipment shall be inspected

c. The control device, HEPA filter shall be checked to insure there is no buildup of material.

d. The source, control device and HEPA filter shall be checked for fugitive emissions.

The permittee shall record the results of each reading and inspection on the approved inspection sheets. Any corrective actions should also be recorded in this manner.

009 [40 CFR Part 60 Standards of Performance for New Stationary Sources §40 CFR 60.373]**Subpart KK - Standards of Performance for Lead-Acid Battery Manufacturing Plants****Monitoring of emissions and operations.**

This condition applies to Source 146 and Control Device C28:

The owner or operator of any lead-acid battery manufacturing facility subject to the provisions of this subpart and controlled by a scrubbing system(s) shall install, calibrate, maintain, and operate a monitoring device(s) that measures and records the pressure drop across the scrubbing system(s) at least once every 15 minutes. The monitoring device shall have an accuracy of ± 5 percent over its operating range.

IV. RECORDKEEPING REQUIREMENTS.

No additional record keeping requirements exist except as provided in other sections of this permit including Section B (Title V General Requirements).

V. REPORTING REQUIREMENTS.

No additional reporting requirements exist except as provided in other sections of this permit including Section B (Title V General Requirements).

VI. WORK PRACTICE REQUIREMENTS.**# 010 [25 Pa. Code §127.441]****Operating permit terms and conditions.**

The permittee shall inspect the Source 725 (Industrial Auto Heat Seal) as follows:

a. The permittee shall periodically conduct a visible inspection of each of the fiberglass filters. Any damaged or nonfunctioning filters shall be replaced. The frequency of these inspections shall be monthly, except as provided in the

**SECTION E. Source Group Restrictions.**

Section C 90% Monitoring Condition.

b. The permittee shall maintain records of the monthly inspections of the filters including the results of the inspections and any actions.

c. The fiber bed method of control may be changed to an equivalent method upon receipt of written approval from the Department. The permittee may request such approval via an RFD. If the RFD is denied, the permittee must use a plan approval application to request the change.

011 [25 Pa. Code §127.441]**Operating permit terms and conditions.**

The permittee shall exhaust each formation operation through Department approved mist eliminators only.

012 [25 Pa. Code §127.441]**Operating permit terms and conditions.**

Equipment (a differential manometer or equivalent, as approved by the Department), shall be installed and maintained so that at any time the pressure drop across each fabric collector, rotoclone, mist eliminator and/or HEPA filter can be measured.

VII. ADDITIONAL REQUIREMENTS.**# 013 [40 CFR Part 60 Standards of Performance for New Stationary Sources §40 CFR 60.370]****Subpart KK - Standards of Performance for Lead-Acid Battery Manufacturing Plants****Applicability and designation of affected facility.**

All of the sources in this source group except for Sources 141, 149, 150, 518, 718, 725, 726 and 727 are subject to Subpart KK of the Standards of Performance for New Stationary Sources and shall comply with all applicable requirements of this Subpart. 40 CFR Section 60.4 requires submission of copies of all requests, reports, applications, submittals and other communications to both EPA and the Department.

The EPA copies shall be forwarded to:

Associate Director
United States Environmental Protection Agency
Region III, Enforcement & Compliance Assurance Division
Air, RCRA and Toxics Branch (3ED21)
Four Penn Center
1600 John F. Kennedy Boulevard
Philadelphia, Pennsylvania 19103-2852

Unless otherwise approved by DEP, the DEP copies shall be reported through the Department's Greenport PUP system available through: <https://greenport.pa.gov/ePermitPublicAccess/PublicSubmission/Home>

*** **Permit Shield in Effect.** ***

**SECTION E. Source Group Restrictions.**

Group Name: SG 05 OXIDE PLANT

Group Description: Oxide Plant

Sources included in this group

ID	Name
126	LEAD OXIDE MILL 1
127	LEAD OXIDE MILL 3
128	LEAD OXIDE MILL 2
129	LEAD OXIDE MILL 4
160	LEAD OXIDE MILL 5
161	LEAD OXIDE MILL 6
162	LEAD OXIDE MILL 7
163	LEAD OXIDE MILL 8
169	LEAD OXIDE MILL 9
170	LEAD OXIDE MILL 10
196	LEAD OXIDE MILL 11
197	LEAD OXIDE MILL 12
198	LEAD OXIDE MILL 13
199	LEAD OXIDE MILL 14
203	LEAD OXIDE MILL 15
204	LEAD OXIDE MILL 16
205	LEAD OXIDE MILL 17
206	LEAD OXIDE MILL 18
207	LEAD OXIDE MILL 19
208	LEAD OXIDE MILL 20
221	LEAD OXIDE MILL NO. 21
222	LEAD OXIDE MILL NO. 22
223	LEAD OXIDE MILL NO. 23
224	LEAD OXIDE MILL NO. 24
225	LEAD OXIDE MILL NO. 25
226	LEAD OXIDE MILL NO. 26
227	LEAD OXIDE MILL NO. 27
228	LEAD OXIDE MILL NO. 28
229	LEAD OXIDE MILL NO. 29
230	LEAD OXIDE MILL NO. 30
231	LEAD OXIDE MILL NO. 31
232	LEAD OXIDE MILL NO. 32
233	LEAD OXIDE MILL NO. 33
234	LEAD OXIDE MILL NO. 34
235	LEAD OXIDE MILL NO. 35 (A-4)
236	LEAD OXIDE MILL NO. 36 (A-4)
237	LEAD OXIDE MILL NO. 37 (A-4)
238	LEAD OXIDE MILL NO. 38 (A-4)
239	LEAD OXIDE MILL NO. 39 (A-4)
240	LEAD OXIDE MILL NO. 40 (A-4)

I. RESTRICTIONS.

**SECTION E. Source Group Restrictions.****Emission Restriction(s).****# 001 [25 Pa. Code §123.21]****General**

No person may permit the emission into the outdoor atmosphere of sulfur oxides from a source in a manner that the concentration of the sulfur oxides, expressed as SO₂, in the effluent gas exceeds 500 parts per million, by volume, dry basis.

002 [25 Pa. Code §127.441]**Operating permit terms and conditions.**

[Additional authority for parts of this condition are derived from 40 CFR Part 60, Subpart KK, NSPS]

The permittee shall limit the lead emissions to the outdoor atmosphere from each mill to 0.01 pounds per ton of lead feed.

003 [25 Pa. Code §127.441]**Operating permit terms and conditions.**

[Additional authority for parts of this condition are derived from 40 CFR Part 60, Subpart KK, NSPS]

The permittee shall operate each mill in a manner that results in no visible emissions to the outdoor atmosphere.

004 [25 Pa. Code §127.441]**Operating permit terms and conditions.**

The permittee shall limit the lead emissions to the outdoor atmosphere from each lead oxide mill during any consecutive 12-month period to 0.06 tons.

005 [25 Pa. Code §127.441]**Operating permit terms and conditions.**

The permittee shall limit the particulate emissions to the outdoor atmosphere from the oxide mills to 0.01 grains per dry standard cubic foot. (PA 5069C, 5069F, 5069G, 5069H, 5069I & 5069K)

006 [25 Pa. Code §127.441]**Operating permit terms and conditions.**

a) The permittee shall limit the particulate emissions to the outdoor atmosphere from each oxide mill to 0.01 pounds per hour.

b) The permittee shall limit the particulate emissions to the outdoor atmosphere from each oxide mill to 0.06 tons per year.

Fuel Restriction(s).**# 007 [25 Pa. Code §127.441]****Operating permit terms and conditions.**

The permittee shall only operate the sources of this source group on natural gas and/or a propane-air mixture as a fuel.

Operation Hours Restriction(s).**# 008 [25 Pa. Code §127.441]****Operating permit terms and conditions.**

The operating hours of the following sources shall not exceed 8,600 hours per source during any consecutive 12-month period (rolling basis):

Sources 235 through 240: Oxide Mills No. 35 through No. 40

**SECTION E. Source Group Restrictions.**

The hours of operation for each source shall be recorded.

II. TESTING REQUIREMENTS.

No additional testing requirements exist except as provided in other sections of this permit including Section B (Title V General Requirements).

III. MONITORING REQUIREMENTS.

009 [25 Pa. Code §127.441]

Operating permit terms and conditions.

[Additional authority for this condition is derived from 40 CFR Part 60, Subpart KK, NSPS]

The permittee shall conduct the following monitoring schedule on each control device in this group:

- a. Periodically read and record the pressure drop across each control device equipped with a HEPA filter and the HEPA filter, while the sources are in operation. The frequency of these readings shall be weekly, except as provided in the Section C 90% Monitoring Condition. For those collectors without a HEPA filter, these readings shall be daily, except as provided in the Section C 90% Monitoring Condition.
- b. Periodically read and record the visible emissions from each control device equipped with a HEPA filter, while the sources are in operation. The frequency of these readings shall be weekly, except as provided in the Section C 90% Monitoring Condition. For those collectors without a HEPA filter, these readings shall be daily, except as provided in the Section C 90% Monitoring Condition.
- c. Periodically conduct inspections of each control device and associated equipment, as appropriate, for:
 1. Visually inspect the control device and associated equipment
 2. Check for the proper removal of collected materials
 3. Check for fugitive emissions from the control device

The frequency of these inspections shall be weekly, except as provided in the Section C 90% Monitoring Condition.

- d. Perform a semiannual inspection and maintenance of each fabric collector, HEPA filter and associated equipment. This includes the inspection and maintenance to ensure proper performance of each fabric collector and HEPA filter, including an inspection of the structural and filter integrity of the collector.

The permittee shall record the results of each reading and inspection on the approved inspection sheets. Any corrective actions should also be recorded in this manner.

IV. RECORDKEEPING REQUIREMENTS.

010 [25 Pa. Code §127.441]

Operating permit terms and conditions.

The permittee shall maintain the following records for each mill:

- a. Hours of operation
- b. Monthly amount of lead feed
- c. Monthly lead and particulate/PM-10/PM-2.5 emissions
- d. 12-month rolling lead and particulate/PM-10/PM-2.5 emission totals

**SECTION E. Source Group Restrictions.****V. REPORTING REQUIREMENTS.**

No additional reporting requirements exist except as provided in other sections of this permit including Section B (Title V General Requirements).

VI. WORK PRACTICE REQUIREMENTS.**# 011 [25 Pa. Code §127.441]****Operating permit terms and conditions.**

Equipment (a differential manometer or equivalent, as approved by the Department), shall be installed and maintained so that at any time the pressure drop across each fabric collector and/or HEPA filter can be measured.

VII. ADDITIONAL REQUIREMENTS.**# 012 [40 CFR Part 60 Standards of Performance for New Stationary Sources §40 CFR 60.370]****Subpart KK - Standards of Performance for Lead-Acid Battery Manufacturing Plants****Applicability and designation of affected facility.**

The Lead Oxide Mills No 4 through 40 are subject to Subpart KK of the Standards of Performance for New Stationary Sources and shall comply with all applicable requirements of this Subpart. 40 CFR Section 60.4 requires submission of copies of all requests, reports, applications, submittals and other communications to both EPA and the Department.

The EPA copies shall be forwarded to:

Associate Director
United States Environmental Protection Agency
Region III, Enforcement & Compliance Assurance Division
Air, RCRA and Toxics Branch (3ED21)
Four Penn Center
1600 John F. Kennedy Boulevard
Philadelphia, Pennsylvania 19103-2852

Unless otherwise approved by DEP, the DEP copies shall be reported through the Department's Greenport PUP system available through: <https://greenport.pa.gov/ePermitPublicAccess/PublicSubmission/Home>

In the event that the Federal Subpart that is the subject of this Source Group is revised, the permittee shall comply with the revised version of the subpart, and shall not be required to comply with any provisions in this permit designated as having the subpart as their authority, to the extent that such permit provisions would be inconsistent with the applicable provisions of the revised subpart.

***** Permit Shield in Effect. *****

**SECTION E. Source Group Restrictions.**

Group Name: SG 06 S-1 BATTERY ASSEMBLY

Group Description: S-1 Battery Assembly Plant

Sources included in this group

ID	Name
179	S-1 BATTERY ASSEMBLY (SCIENTIFIC FC #6)
181	S-1 BATTERY ASSMBLY & DRY CHARGE (SCIEN FC #3)
182	S-1 GRIDCAST (SCIENTIFIC FC #1)
182A	S-1 CONCAST (SCIENTIFIC FC #1)
183	S-1 GROUP ASSEMBLY (SCIENTIFIC FC #2)
184	S-1 MIXING (SCIENTIFIC FC #1) & PASTING (SCIENTIFIC FC #4)
185	S-1 LEAD OXIDE STORAGE SILOS (3) (BIN VENTS)
186	S-1 BATTERY ACTTN/BOOSTIN (5 MIST ELIM)
187	S- 1 BATT FORMATION (10 MIST ELIM)
188	S-1 UNIGY & GEL BATT ASSEM (SCIENTIFIC FC #5)
189	S-1 GROUP ASSEMBLY (SCIENTIFIC FC #4)
301	S-1A BATT ASSEMBLY ANNEX (SCIENTIFIC FC 6)
302	S-1A FORMATION ANNEX (3 MIST ELIM)
507	S-1 SMALL PART CASTING (FUGITIVE/UNCONT)
514	S-1 HEAT SEAL BOOTHS #1-3

I. RESTRICTIONS.**Emission Restriction(s).****# 001 [25 Pa. Code §123.21]****General**

No person may permit the emission into the outdoor atmosphere of sulfur oxides from a source in a manner that the concentration of the sulfur oxides, expressed as SO₂, in the effluent gas exceeds 500 parts per million, by volume, dry basis.

Note: This condition is not relevant to Sources 186, 187, 302 or 514 so long as these sources do not emit SO₂.

002 [25 Pa. Code §127.441]**Operating permit terms and conditions.**

[Additional authority for this condition is derived from 25 PA Section 129.91, RACT]

The permittee shall limit the volatile organic compound emissions to the outdoor atmosphere from the Source 182A (S-1 Concast [Caster Wheel]) to 0.02 grains per dry standard cubic foot as measured at the associated stack(s). (PA 5069F)

003 [25 Pa. Code §127.441]**Operating permit terms and conditions.**

[Additional authority for this condition is derived from 40 CFR Part 60, Subpart KK, NSPS]

The permittee shall operate all of the sources of SG06, subject to 40 CFR Part 60, Subpart KK, in a manner that results in no visible emissions to the outdoor atmosphere.

004 [25 Pa. Code §127.441]**Operating permit terms and conditions.**

[Additional authority for parts of this condition are derived from 25 Pa Code Section 123.13]

The permittee shall limit the particulate emissions to the outdoor atmosphere from these sources to the following as measured at the associated control device and/or stack:

**SECTION E. Source Group Restrictions.**

- a. Source 179 (S-1 Battery Assembly: Scientific FC #6) - 0.001 grains per dry standard cubic foot
- b. Source 181 (S-1 Battery Assembly & Dry Charge: Scientific FC #3) - 0.001 grains per dry standard cubic foot (PA 5069N & 5069AE)
- c. Source 182 (S-1 Grid Casting: Scientific FC #1) - 0.001 grains per dry standard cubic foot (PA 5069N)
- d. Source 182A (S-1 Concast [Lead Pots]: Scientific FC #1) - 0.001 grains per dry standard cubic foot (PA 5069F & 5069N)
- e. Source 183 (S-1 Group Assembly: Scientific FC #2) - 0.001 grains per dry standard cubic foot (appl)
- f. Source 184 (S-1 Mixing: Scientific FC #1 & Pasting: Scientific FC #4) - 0.001 grains per dry standard cubic foot (PA 5069J & 5069N)
- g. Source 185 (S-1 Lead Oxide Storage Bins: Bin Vents) - 0.001 grains per dry standard cubic foot (appl)
- h. Source 188 (S-1 Unigy & Gel Battery Assembly: Scientific FC #5) - 0.001 grains per dry standard cubic foot (PA 5069F)
- i. Source 189 (S-1 Group Assembly: Scientific FC#4) - 0.001 grains per dry standard cubic foot (PA 5069F)
- j. Source 301 (S-1A Battery Assembly Annex: Scientific FC #6) - 0.001 grains per dry standard cubic foot (PA 5069F)
- k. Source 507 (S-1 Small Parts Casting) - 0.04 grains per dry standard cubic foot (123.13)
- l. Source 514 (S-1 Heat Seal Booths #1-3: Fiber Beds) - 0.02 grains per dry standard cubic foot (appl)

005 [25 Pa. Code §127.441]**Operating permit terms and conditions.**

The permittee shall limit the emission of sulfuric acid mist (H₂SO₄) to the outdoor atmosphere from the Source 186 (S-1 Battery Activation/Boosting), Source 187 (S-1 Battery Formation) and Source 302 (S-1A Formation) to 0.001 grains per dry standard cubic foot as measured at each mist eliminator stack. (PA 5069F)

006 [40 CFR Part 60 Standards of Performance for New Stationary Sources §40 CFR 60.372]**Subpart KK - Standards of Performance for Lead-Acid Battery Manufacturing Plants
Standards for lead.**

[Additional authority for parts of this condition is derived from 25 Pa Code Section 127.1]

The permittee shall limit the lead emissions to the outdoor atmosphere from these source to the following as measured at the associated control device and/or stack:

- a. Source 179 (S-1 Battery Assembly: Scientific FC #6) - 0.0001 grains per dry standard cubic foot
- b. Source 181 (S-1 Battery Assembly & Dry Charge: Scientific FC #3) - 0.0001 grains per dry standard cubic foot (PA 5069N & 5069AE)
- c. Source 182 (S-1 Gridcast: Scientific FC #1) - 0.0001 grains per dry standard cubic foot (PA 5069N)
- d. Source 182A (S-1 Concast [Lead Pots]: Scientific FC #1) - 0.0001 grains per dry standard cubic foot (PA 5069N)
- e. Source 183 (S-1 Group Assembly: Scientific FC #2) - 0.0001 grains per dry standard cubic foot (appl)
- f. Source 184 (S-1 Mixing: Scientific FC #1 & Pasting: Scientific FC #4) - 0.0001 grains per dry standard cubic foot (PA 5069J & 5069N)
- g. Source 185 (S-1 Lead Oxide Storage Bins: Bin Vents) - 0.0001 grains per dry standard cubic foot (RFD12/09)

**SECTION E. Source Group Restrictions.**

- h. Source 188 (S-1 Unigy & Gel Battery Assembly: Scientific FC #5) - 0.0001 grains per dry standard cubic foot (PA 5069F)
- i. Source 189 (S-1 Group Assembly #2: Scientific FC #4) - 0.0001 grains per dry standard cubic foot (PA 5069F)
- j. Source 301 (S-1A Battery Assembly Annex: Scientific FC #6) - 0.0001 grains per dry standard cubic foot (PA 5069F)
- k. Source 507 (S-1 Small Parts Casting) - 0.000437 grains per dry standard cubic foot (NSPS/MACT)

Fuel Restriction(s).**# 007 [25 Pa. Code §127.441]****Operating permit terms and conditions.**

The permittee shall only operate the sources in this source group on natural gas and/or a propane-air mixture as a fuel.

II. TESTING REQUIREMENTS.

No additional testing requirements exist except as provided in other sections of this permit including Section B (Title V General Requirements).

III. MONITORING REQUIREMENTS.**# 008 [25 Pa. Code §127.441]****Operating permit terms and conditions.**

[Additional authority for this condition is derived from 40 CFR Part 60, Subpart KK, NSPS]

The permittee shall conduct the following monitoring schedule on each particulate, lead and/or sulfuric acid mist control device in this group, except the Source 185 (S-1 Lead Oxide Storage Silos):

- a. Periodically read and record the pressure drop across each control device equipped with a HEPA filter and the HEPA filter, while the sources are in operation. The frequency of these readings shall be weekly, except as provided in the Section C 90% Monitoring Condition. For those collectors without a HEPA filter, these readings shall be daily, except as provided in the Section C 90% Monitoring Condition.
- b. Periodically read and record the visible emissions from each control device equipped with a HEPA filter, while the sources are in operation. The frequency of these readings shall be weekly, except as provided in the Section C 90% Monitoring Condition. For those collectors without a HEPA filter, these readings shall be daily, except as provided in the Section C 90% Monitoring Condition.
- c. Periodically conduct inspections of each control device and associated equipment, as appropriate, for:
 - 1. Visually inspect the control device and associated equipment
 - 2. Check for the proper removal of collected materials
 - 3. Check for fugitive emissions from the control device

The frequency of these inspections shall be weekly, except as provided in the Section C 90% Monitoring Condition.

d. Ensure that the mist eliminator pads are rinsed in accordance with manufacturer recommendations.

e. Perform a semiannual inspection and maintenance of each fabric collector, HEPA filter and associated equipment. This includes the inspection and maintenance to ensure proper performance of each fabric collector and HEPA filter, including an inspection of the structural and filter integrity of the collector.

The permittee shall record the results of each reading and inspection on the approved inspection sheets. Any corrective actions should also be recorded in this manner.

**SECTION E. Source Group Restrictions.****# 009 [25 Pa. Code §127.441]****Operating permit terms and conditions.**

The permittee shall inspect the Source 185 (S-1 Lead Oxide Storage Silos (2): Bin Vents) as follows:

Annually, during a delivery:

The permittee shall read and record the visible emissions from each bin vent using US EPA Method 22.

Quarterly:

- a. The pressure drop across the control devices and HEPA filter shall be read, while the silos are being filled.
- b. The control devices, HEPA filter and associated equipment shall be inspected including structural and filter integrity.
- c. The control device and HEPA filter shall be checked to insure there is no excess buildup of materials.
- d. The source, control device and HEPA filter shall be checked for fugitive emissions.

The permittee shall record the results of each reading and inspection on the approved inspection sheets. Any corrective actions should also be recorded in this manner.

IV. RECORDKEEPING REQUIREMENTS.

No additional record keeping requirements exist except as provided in other sections of this permit including Section B (Title V General Requirements).

V. REPORTING REQUIREMENTS.

No additional reporting requirements exist except as provided in other sections of this permit including Section B (Title V General Requirements).

VI. WORK PRACTICE REQUIREMENTS.**# 010 [25 Pa. Code §127.441]****Operating permit terms and conditions.**

Equipment (a differential manometer or equivalent, as approved by the Department), shall be installed and maintained so that at any time the pressure drop across each fabric collector, mist eliminator and/or HEPA filter can be measured.

011 [25 Pa. Code §127.441]**Operating permit terms and conditions.**

The permittee shall exhaust each formation operation through the Department approved mist eliminators only.

VII. ADDITIONAL REQUIREMENTS.**# 012 [40 CFR Part 60 Standards of Performance for New Stationary Sources §40 CFR 60.370]****Subpart KK - Standards of Performance for Lead-Acid Battery Manufacturing Plants****Applicability and designation of affected facility.**

All of the sources in this group source except formation (186 & 187) and heat sealers (514) are subject to Subpart KK of the Standards of Performance for New Stationary Sources and shall comply with all applicable requirements of this Subpart. 40 CFR Section 60.4 requires submission of copies of all requests, reports, applications, submittals and other communications to both EPA and the Department.

The EPA copies shall be forwarded to:

Associate Director
United States Environmental Protection Agency

**SECTION E. Source Group Restrictions.**

Region III, Enforcement & Compliance Assurance Division
Air, RCRA and Toxics Branch (3ED21)
Four Penn Center
1600 John F. Kennedy Boulevard
Philadelphia, Pennsylvania 19103-2852

Unless otherwise approved by DEP, the DEP copies shall be reported through the Department's Greenport PUP system available through: <https://greenport.pa.gov/ePermitPublicAccess/PublicSubmission/Home>

In the event that the Federal Subpart that is the subject of this Source Group is revised, the permittee shall comply with the revised version of the subpart, and shall not be required to comply with any provisions in this permit designated as having the subpart as their authority, to the extent that such permit provisions would be inconsistent with the applicable provisions of the revised subpart.

***** Permit Shield in Effect. *****

**SECTION E. Source Group Restrictions.**

Group Name: SG 07 WASTE WATER TP
 Group Description: Waste Water Treatment Plant

Sources included in this group

ID	Name
210	WTP SALT DRYER
211	WTP SALT TRUCK LOADOUT OPERATION
212	WTP SALT STORAGE SILOS

I. RESTRICTIONS.**Emission Restriction(s).****# 001 [25 Pa. Code §123.13]****Processes**

The permittee shall limit the emissions of particulate matter to the outdoor atmosphere from the sources in a manner that the concentration of particulate matter in the effluent gas does not exceed 0.04 grain per dry standard cubic foot.

002 [25 Pa. Code §123.21]**General**

No person may permit the emission into the outdoor atmosphere of sulfur oxides from a source in a manner that the concentration of the sulfur oxides, expressed as SO₂, in the effluent gas exceeds 500 parts per million, by volume, dry basis.

003 [25 Pa. Code §127.441]**Operating permit terms and conditions.**

In the event that visible emissions are observed from any of the sources in this Source Group, the permittee shall take any appropriate corrective action within 15 days.

Fuel Restriction(s).**# 004 [25 Pa. Code §127.441]****Operating permit terms and conditions.**

The permittee shall only operate the sources in this source group on natural gas and/or a propane-air mixture as a fuel.

II. TESTING REQUIREMENTS.

No additional testing requirements exist except as provided in other sections of this permit including Section B (Title V General Requirements).

III. MONITORING REQUIREMENTS.**# 005 [25 Pa. Code §127.441]****Operating permit terms and conditions.**

The permittee shall periodically conduct the following monitoring of each particulate control device in this group:

- a. read the pressure drop across the control device.
- b. observe the control device for:
 1. Wear and damage
 2. Removal of collected materials
 3. Fugitive emissions from the control device
 4. Operation of the control device

The frequency of these readings and observations shall be weekly, in any week in which the respective source for the

**SECTION E. Source Group Restrictions.**

control device operates, except as provided in the Section C 90% Monitoring Condition.

The permittee shall record the results of each inspection on the approved inspection sheets. If a source did not operate in a given week, that fact shall also be noted on the approved inspection sheets.

IV. RECORDKEEPING REQUIREMENTS.

No additional record keeping requirements exist except as provided in other sections of this permit including Section B (Title V General Requirements).

V. REPORTING REQUIREMENTS.

No additional reporting requirements exist except as provided in other sections of this permit including Section B (Title V General Requirements).

VI. WORK PRACTICE REQUIREMENTS.**# 006 [25 Pa. Code §127.441]
Operating permit terms and conditions.**

Equipment (a differential manometer or equivalent, as approved by the Department), shall be installed and maintained so that at any time the pressure drop across each fabric collector can be measured.

VII. ADDITIONAL REQUIREMENTS.

No additional requirements exist except as provided in other sections of this permit including Section B (Title V General Requirements).

***** Permit Shield in Effect. *****

**SECTION E. Source Group Restrictions.**

Group Name: SG 08 A-4 BATTERY ASSEMBLY PLANT

Group Description: A-4 Battery Assembly Plant

Sources included in this group

ID	Name
401	A-4 LEAD OXIDE STORAGE SILOS (9) (BIN VENTS)
402	A-4 MIXING (SCIEN #6) & PASTING (SCIEN #1)
403	A-4 GRIDCASTING (SCIEN FC #2)
404	A-4 CONCASTING (SCIEN FC #2)
405	A-4 THREE-PROCESS-OPR (FC #3 & #4 & #7)
406	A-4 BATTERY FORMATION (9) (MIST ELIM)
407	A-4 BATT ASSEMBLY LINES (SCIEN FC #5)
516	A-4 HEAT & LID SEAL BOOTHS 1 - 14: FIBER BEDS OR EQUIV CTRL

I. RESTRICTIONS.**Emission Restriction(s).****# 001 [25 Pa. Code §123.21]****General**

No person may permit the emission into the outdoor atmosphere of sulfur oxides from a source in a manner that the concentration of the sulfur oxides, expressed as SO₂, in the effluent gas exceeds 500 parts per million, by volume, dry basis.

Note: This condition is not relevant to Sources 406 and 516 so long as these sources do not emit SO₂.

002 [25 Pa. Code §127.441]**Operating permit terms and conditions.**

[Additional authority for this condition is derived from 40 CFR Part 60, Subpart KK, NSPS]

The permittee shall operate all of the sources of SG08, subject to 40 CFR Part 60, Subpart KK, in a manner that results in no visible emissions to the outdoor atmosphere.

003 [25 Pa. Code §127.441]**Operating permit terms and conditions.**

The permittee shall limit the emissions of sulfuric acid (H₂SO₄) to the outdoor atmosphere from the Source 406 (A-4 Battery Formation) to 0.001 grains per dry standard cubic foot based on the US EPA Test Method 8 as found in 40 CFR Part 60 or any other method approved by the Department as measured at each mist eliminator stack. (PA 5069K)

004 [25 Pa. Code §127.441]**Operating permit terms and conditions.**

The permittee shall limit the particulate/PM-10/PM-2.5 emissions to the outdoor atmosphere from each of the sources in this source group except Sources 406 (A-4 Battery Formation) and 516 (A-4 Heat Seal) to 0.001 grains per dry standard cubic foot as measured at the associated control device and/or stack.

005 [25 Pa. Code §127.441]**Operating permit terms and conditions.**

[Additional authority for this condition is derived from 40 CFR Part 60, Subpart KK, NSPS]

The permittee shall limit the lead emissions to the outdoor atmosphere from all of the sources in this source group except Source 406 (A-4 Battery Formation) and Source 516 (A-4 Heat Sealing) to 0.0001 grains per dry standard cubic foot as measured at the associated control device and/or stack. (PA 5069K)

**SECTION E. Source Group Restrictions.****# 006 [25 Pa. Code §127.441]****Operating permit terms and conditions.**

The permittee shall limit the emissions of particulate/PM-10/PM-2.5 to the outdoor atmosphere from the Heat Sealing Operation Source 516 (A-4 Heat Sealing) to 0.0075 grains per dry standard cubic foot as measured in the stack (S516). (PA 5069K)

007 [25 Pa. Code §127.441]**Operating permit terms and conditions.**

The fugitive emissions (Z400) from the Sources 405 (A-4 Three-Process-Operation) and 407 (A-4 Battery Assembly Lines) are not subject to 40 CFR Part 60, Subpart KK, NSPS. (PA 06-05069K)

008 [25 Pa. Code §127.441]**Operating permit terms and conditions.**

The permittee shall limit the emissions of VOCs to the outdoor atmosphere from Source 407 to 5.0 tons during any consecutive 12-month period (the totals do not include the emissions from the combustion of fuels, which are measured and recorded under a facility-wide limitation).

Fuel Restriction(s).**# 009 [25 Pa. Code §127.441]****Operating permit terms and conditions.**

The permittee shall operate the sources in this source group using only natural gas and/or a propane-air mixture as a fuel.

II. TESTING REQUIREMENTS.

No additional testing requirements exist except as provided in other sections of this permit including Section B (Title V General Requirements).

III. MONITORING REQUIREMENTS.**# 010 [25 Pa. Code §127.441]****Operating permit terms and conditions.**

[Additional authority for parts of this condition is derived from 40 CFR Part 60, Subpart KK, NSPS]

The permittee shall adhere to the following monitoring schedule for each particulate, lead and/or sulfuric acid mist control device in this source group except Source 401 (A-4 Lead Oxide Storage Silos):

- a. Periodically read and record the pressure drop across each control device equipped with a HEPA filter and the HEPA filter, while the sources are in operation. The frequency of these readings shall be weekly, except as provided in the Section C 90% Monitoring Condition. For those collectors without a HEPA filter, these readings shall be daily, except as provided in the Section C 90% Monitoring Condition.
- b. Periodically read and record the visible emissions from each control device equipped with a HEPA filter, while the sources are in operation. The frequency of these readings shall be weekly, except as provided in the Section C 90% Monitoring Condition. For those collectors without a HEPA filter, these readings shall be daily, except as provided in the Section C 90% Monitoring Condition.
- c. Periodically conduct inspections of each control device and associated equipment, as appropriate, for:
 1. Visually inspect the control device and associated equipment
 2. Check for the proper removal of collected materials
 3. Check for fugitive emissions from the control device

**SECTION E. Source Group Restrictions.**

The frequency of these inspections shall be weekly, except as provided in the Section C 90% Monitoring Condition.

d. Ensure that the mist eliminator pads are rinsed in accordance with manufacturer's recommendations.

Source 516 Heat Sealing Operation is exempt from Item d.

e. Perform a semiannual inspection and maintenance of the each fabric collector, HEPA filter and associated equipment. This includes an inspection and maintenance to ensure proper performance of each fabric collector and HEPA filter, including an inspection of the structural and filter integrity of the collector and HEPA filter.

The permittee shall record the results of each reading and inspection on the approved inspection sheets. Any corrective actions should also be recorded in this manner.

011 [25 Pa. Code §127.441]**Operating permit terms and conditions.**

The permittee shall inspect the Source 401 (A-4 Lead Oxide Storage Silos: Bin Vents) as follows:

a. Annually, during a delivery:

The permittee shall read and record the visible emissions from each silo using US EPA Method 22.

b. Quarterly:

1. The pressure drop across the control devices and HEPA filter shall be read, while the silos are being filled.

2. The control device, HEPA filter and associated equipment shall be inspected including structural and filter integrity.

3. The control device and HEPA filter shall be checked to insure there is no excess build-up of material.

4. The source, control device and HEPA filter shall be checked for fugitive emissions.

The permittee shall record the results of each reading and inspection on the approved inspection sheets. Any corrective actions should also be recorded in this manner.

IV. RECORDKEEPING REQUIREMENTS.**# 012 [25 Pa. Code §127.441]****Operating permit terms and conditions.**

The permittee shall maintain the necessary information required to determine the monthly emissions of VOCs limited in Condition #008 of this Group Source. These monthly emissions shall also be maintained in a 12-month rolling total.

013 [25 Pa. Code §127.441]**Operating permit terms and conditions.**

The permittee shall record the quantity and identity of all VOC solvents used in the finishing operation of Source 407 (A-4 Battery Assembly Lines) on a monthly basis. These records shall be maintained and shall be made part of the permittee's annual "AIMS" report to the Department.

014 [25 Pa. Code §127.441]**Operating permit terms and conditions.**

Manufacturer supplied Certification Product Data Sheets (CPDS) and/or Material Safety Data Sheets (MSDS) for all solvents used on the Source 407 (A-4 Battery Assembly Lines) within the most recent five years shall be maintained at the above facility and be made available to the Department at any time.

**SECTION E. Source Group Restrictions.****V. REPORTING REQUIREMENTS.**

No additional reporting requirements exist except as provided in other sections of this permit including Section B (Title V General Requirements).

VI. WORK PRACTICE REQUIREMENTS.**# 015 [25 Pa. Code §127.441]****Operating permit terms and conditions.**

Equipment (a differential manometer or equivalent, as approved by the Department), shall be installed and maintained so that at any time the pressure drop across each fabric collector, HEPA filter, filter bed mist collector and/or mist eliminator can be measured.

016 [25 Pa. Code §127.441]**Operating permit terms and conditions.**

The permittee shall exhaust each formation operation through the Department approved mist eliminators only.

017 [25 Pa. Code §127.441]**Operating permit terms and conditions.**

The permittee shall limit the VOC emissions from the finishing operation part of Source 407 (A-4 Battery Assembly Lines) in the following manner:

- a. All solvents shall be stored in plunger cans or equivalent.
- b. All rags containing solvent shall be placed into storage containers (triangular red cans or others approved by the Department) for storage.
- c. All rags containing solvents shall be placed into sealed Haz-Waste drums and removed from the facility as part of disposal.

018 [25 Pa. Code §127.441]**Operating permit terms and conditions.**

The permittee shall operate the combustion sources in a manner consistent with good combustion practices.

VII. ADDITIONAL REQUIREMENTS.**# 019 [40 CFR Part 60 Standards of Performance for New Stationary Sources §40 CFR 60.370]****Subpart KK - Standards of Performance for Lead-Acid Battery Manufacturing Plants****Applicability and designation of affected facility.**

All of the sources in this source group except formation (Source 406) and Heat Seal (Source 516) are subject to Subpart KK of the Standards of Performance for New Stationary Sources and shall comply with all applicable requirements of this Subpart. 40 CFR Section 60.4 requires submission of copies of all requests, reports, applications, submittals and other communications to both EPA and the Department.

The EPA copies shall be forwarded to:

Associate Director
 United States Environmental Protection Agency
 Region III, Enforcement & Compliance Assurance Division
 Air, RCRA and Toxics Branch (3ED21)
 Four Penn Center
 1600 John F. Kennedy Boulevard
 Philadelphia, Pennsylvania 19103-2852

Unless otherwise approved by DEP, the DEP copies shall be reported through the Department's Greenport PUP system available through: <https://greenport.pa.gov/ePermitPublicAccess/PublicSubmission/Home>

In the event that the Federal Subpart that is the subject of this Source Group is revised, the permittee shall comply with the revised version of the subpart, and shall not be required to comply with any provisions in this permit designated as having

**SECTION E. Source Group Restrictions.**

the subpart as their authority, to the extent that such permit provisions would be inconsistent with the applicable provisions of the revised subpart.

***** Permit Shield in Effect. *****

**SECTION E. Source Group Restrictions.**

Group Name: SG 09 SUBPART ZZZZ
 Group Description: Pre-2006 Emergency RICE
 Sources included in this group

ID	Name
601A	EMERGENCY ENGINES PRE-2006

I. RESTRICTIONS.**Emission Restriction(s).****# 001 [40 CFR Part 63 NESHAPS for Source Categories §40 CFR 63.6595]****Subpart ZZZZ - National Emissions Standards for Hazardous Air Pollutants for Stationary Reciprocating Internal Combustion Engines****When do I have to comply with this subpart?**

- 1.) If you have an existing stationary CI RICE with a site rating of less than or equal to 500 brake HP located at a major source of HAP emissions, you must comply with the applicable emission limitations and operating limitations in this Source Group by no later than May 3, 2013
- 2.) If you have an existing stationary SI RICE with a site rating of less than or equal to 500 brake HP located at a major source of HAP emissions, you must comply with the applicable emission limitations and operating limitations in this Source Group by no later than October 19, 2013.

II. TESTING REQUIREMENTS.

No additional testing requirements exist except as provided in other sections of this permit including Section B (Title V General Requirements).

III. MONITORING REQUIREMENTS.

No additional monitoring requirements exist except as provided in other sections of this permit including Section B (Title V General Requirements).

IV. RECORDKEEPING REQUIREMENTS.**# 002 [40 CFR Part 63 NESHAPS for Source Categories §40 CFR 63.6655]****Subpart ZZZZ - National Emissions Standards for Hazardous Air Pollutants for Stationary Reciprocating Internal Combustion Engines****What records must I keep?**

- (e) The permittee shall keep records of the maintenance conducted on the stationary reciprocating internal combustion engines (RICE) operated at the lead-acid battery manufacturing facility in order to demonstrate that the stationary RICE were operated and maintained according to the maintenance plan.
- (f) The permittee shall keep records of the hours of operation of each engine, recorded through its non-resettable hour meter. The owner or operator must document how many hours are spent for emergency operation, including what classified the operation as emergency and how many hours are spent for non-emergency operation.

003 [40 CFR Part 63 NESHAPS for Source Categories §40 CFR 63.6660]**Subpart ZZZZ - National Emissions Standards for Hazardous Air Pollutants for Stationary Reciprocating Internal Combustion Engines****In what form and how long must I keep my records?**

- (a) Records kept pursuant to this Source Group must be in a form suitable and readily available for expeditious review.
- (b) - (c) The permittee shall keep each record pursuant to this Source Group readily accessible in hard copy or electronic form for at least 5 years after the date of each occurrence, measurement, maintenance, corrective action, report, or record.

**SECTION E. Source Group Restrictions.****V. REPORTING REQUIREMENTS.**

No additional reporting requirements exist except as provided in other sections of this permit including Section B (Title V General Requirements).

VI. WORK PRACTICE REQUIREMENTS.**# 004 [40 CFR Part 63 NESHAPS for Source Categories §40 CFR 63.6602]****Subpart ZZZZ - National Emissions Standards for Hazardous Air Pollutants for Stationary Reciprocating Internal Combustion Engines****What emission limitations must I meet if I own or operate an existing stationary RICE with a site rating of equal to or less than 500 brake HP located at a major source of HAP emissions?**

The permittee shall perform the following operational and maintenance requirements on each of the stationary reciprocating internal combustion engines (RICE) operated at the lead-acid battery manufacturing facility as specified by 40 CFR §63.6602 and Table 2c

- a. Change oil and filter every 500 hours of operation or annually, whichever comes first,
- b. Inspect air cleaner every 1,000 hours of operation or annually, whichever comes first,
- c. Inspect all hoses and belts every 500 hours of operation or annually, whichever comes first, and replace as necessary.
- d. Minimize the engine's time spent at idle and minimize the engine's startup time at startup to a period needed for appropriate and safe loading of the engine, not to exceed 30 minutes, after which time the non-startup emission limitations apply.

005 [40 CFR Part 63 NESHAPS for Source Categories §40 CFR 63.6625]**Subpart ZZZZ - National Emissions Standards for Hazardous Air Pollutants for Stationary Reciprocating Internal Combustion Engines****What are my monitoring, installation, operation, and maintenance requirements?**

(e) and Table 6: The permittee shall operate and maintain the stationary reciprocating internal combustion engines (RICE) at the lead-acid battery manufacturing facility according to the manufacturer's emission-related operation and maintenance instructions; or the permittee shall develop and follow a maintenance plan. The maintenance plan must provide for the maintenance and operation of the engine in a manner consistent with good air pollution control practice for minimizing emissions.

006 [40 CFR Part 63 NESHAPS for Source Categories §40 CFR 63.6625]**Subpart ZZZZ - National Emissions Standards for Hazardous Air Pollutants for Stationary Reciprocating Internal Combustion Engines****What are my monitoring, installation, operation, and maintenance requirements?**

(f) If you own or operate an existing emergency stationary RICE with a site rating of less than or equal to 500 brake HP located at a major source of HAP emissions you must install a non-resettable hour meter if one is not already installed.

007 [40 CFR Part 63 NESHAPS for Source Categories §40 CFR 63.6625]**Subpart ZZZZ - National Emissions Standards for Hazardous Air Pollutants for Stationary Reciprocating Internal Combustion Engines****What are my monitoring, installation, operation, and maintenance requirements?**

(i) If you own or operate a stationary CI engine that is subject to the work, operation or management practices in items 1 or 2 of Table 2c to this subpart or in items 1 or 4 of Table 2d to this subpart [TABLE 2C 1 APPLIES], you have the option of utilizing an oil analysis program in order to extend the specified oil change requirement in Tables 2c and 2d to this subpart. The oil analysis must be performed at the same frequency specified for changing the oil in Table 2c or 2d to this subpart. The analysis program must at a minimum analyze the following three parameters: Total Base Number, viscosity, and percent water content. The condemning limits for these parameters are as follows: Total Base Number is less than 30 percent of the Total Base Number of the oil when new; viscosity of the oil has changed by more than 20 percent from the viscosity of the oil when new; or percent water content (by volume) is greater than 0.5. If all of these condemning limits are not exceeded, the engine owner or operator is not required to change the oil. If any of the limits are exceeded, the engine owner or operator must change the oil within 2 days of receiving the results of the analysis; if the engine is not in operation when the results of the analysis are received, the engine owner or operator must change the oil within 2 days or before commencing operation, whichever is later. The owner or operator must keep records of the parameters that are analyzed as part of the program, the results of the analysis, and the oil changes for the engine. The analysis program must be part of the maintenance plan for the engine.

(j) If you own or operate a stationary SI engine that is subject to the work, operation or management practices in items 6, 7,

**SECTION E. Source Group Restrictions.**

or 8 of Table 2c to this subpart or in items 5, 6, 7, 9, or 11 of Table 2d to this subpart [TABLE 2C 6 APPLIES], you have the option of utilizing an oil analysis program in order to extend the specified oil change requirement in Tables 2c and 2d to this subpart. The oil analysis must be performed at the same frequency specified for changing the oil in Table 2c or 2d to this subpart. The analysis program must at a minimum analyze the following three parameters: Total Acid Number, viscosity, and percent water content. The condemning limits for these parameters are as follows: Total Acid Number increases by more than 3.0 milligrams of potassium hydroxide (KOH) per gram from Total Acid Number of the oil when new; viscosity of the oil has changed by more than 20 percent from the viscosity of the oil when new; or percent water content (by volume) is greater than 0.5. If all of these condemning limits are not exceeded, the engine owner or operator is not required to change the oil. If any of the limits are exceeded, the engine owner or operator must change the oil within 2 days of receiving the results of the analysis; if the engine is not in operation when the results of the analysis are received, the engine owner or operator must change the oil within 2 days or before commencing operation, whichever is later. The owner or operator must keep records of the parameters that are analyzed as part of the program, the results of the analysis, and the oil changes for the engine. The analysis program must be part of the maintenance plan for the engine.

008 [40 CFR Part 63 NESHAPS for Source Categories §40 CFR 63.6640]**Subpart ZZZZ - National Emissions Standards for Hazardous Air Pollutants for Stationary Reciprocating Internal Combustion Engines****How do I demonstrate continuous compliance with the emission limitations, operating limitations, and other requirements?**

(f) The permittee shall not operate the stationary reciprocating internal combustion engines (RICE) at the lead-acid battery manufacturing facility in such a way that exceeds the following operating hour limits for each engine:

a. 50 hours per year for non-emergency operation.

b. 100 hours per year for maintenance and readiness test runs, provided that the tests are recommended by Federal, State or local government, the manufacturer, the vendor, or the insurance company associated with the engine.

The permittee may operate the stationary reciprocating internal combustion engines (RICE) operated at the lead-acid battery manufacturing facility for up to 50 hours per year in nonemergency situations, but those 50 hours are counted towards the 100 hours per year provided for maintenance and testing. The 50 hours per year for non-emergency situations cannot be used for peak shaving or to generate income for the facility.

(f)(1)(i) There is no time limit on the use of emergency stationary RICE in emergency situations.

(f)(2)(ii) - (iii) [NA - VACATED AS OF 5/2/16 PER COURT ORDER]

VII. ADDITIONAL REQUIREMENTS.**# 009 [40 CFR Part 63 NESHAPS for Source Categories §40 CFR 63.6665]****Subpart ZZZZ - National Emissions Standards for Hazardous Air Pollutants for Stationary Reciprocating Internal Combustion Engines****What parts of the General Provisions apply to me?**

If you own or operate a new or reconstructed stationary RICE with a site rating of less than or equal to 500 brake HP located at a major source of HAP emissions, you do not need to comply with any of the requirements of the General Provisions specified in Table 8 of Subpart ZZZZ.

*** **Permit Shield in Effect.** ***

**SECTION E. Source Group Restrictions.**

Group Name: SG10B RACT 2

Group Description: RACT 2 Presumptive

Sources included in this group

ID	Name
133A	A-2 CONCASTER (SCIEN FC #1 & SCIEN FC #10)
156A	A-3 CONCAST (SCIEN FC 6)
182A	S-1 CONCAST (SCIENTIFIC FC #1)
214	SPRAY BOOTH- CENTRAL MAINT PAINT BOOTH
404	A-4 CONCASTING (SCIEN FC #2)
508	A-2 COS/ENVELOPE/CONCAST (SCIEN 10)
601A	EMERGENCY ENGINES PRE-2006
601B	EMERGENCY SI ENGINES POST-2006
601C	EMERGENCY CI ENGINES POST-2006
603	SMALL PARTS COATING OPERATION
604	IND BATTERY TOUCH-UP OPERATION
699	5D SOURCES
700	MISC COMBUSTION SOURCES (NOT 5D, NOT EMERGENCY GEN)

I. RESTRICTIONS.

No additional requirements exist except as provided in other sections of this permit including Section B (Title V General Requirements).

II. TESTING REQUIREMENTS.

No additional testing requirements exist except as provided in other sections of this permit including Section B (Title V General Requirements).

III. MONITORING REQUIREMENTS.

No additional monitoring requirements exist except as provided in other sections of this permit including Section B (Title V General Requirements).

IV. RECORDKEEPING REQUIREMENTS.

No additional record keeping requirements exist except as provided in other sections of this permit including Section B (Title V General Requirements).

V. REPORTING REQUIREMENTS.

No additional reporting requirements exist except as provided in other sections of this permit including Section B (Title V General Requirements).

VI. WORK PRACTICE REQUIREMENTS.

No additional work practice requirements exist except as provided in other sections of this permit including Section B (Title V General Requirements).

VII. ADDITIONAL REQUIREMENTS.**# 001 [25 Pa. Code §129.91]****Control of major sources of NOx and VOCs**

[Additional authority for this condition is found in 25 Pa. Code Sections 129.91-129.95]

General condition for all sources:

- a. SG 10B RACT 2 applies only to those emissions units that were in operation prior to July 21, 2012.

**SECTION E. Source Group Restrictions.**

AAA for Sources 699 & 700

1) In accordance with 25 PA Code 129.97(c)(3), beginning on January 1, 2017, the permittee shall operate and maintain all combustion sources with an individual rated gross heat input less than 20 million Btu/hr in accordance with manufacturer specifications and with good operating practices to limit NOx and VOC emissions.

BBB for Sources 601A, 601B & 601C

1) In accordance with 25 PA Code 129.97(c)(5), beginning on January 1, 2017, the permittee shall operate and maintain all ICE in accordance with manufacturer specifications and with good operating practices to limit NOx and VOC emissions.

CCC for Sources 214, 603 & 604, Concasting

1) In accordance with 25 PA Code 129.97(c)(2), beginning on January 1, 2017, the permittee shall operate and maintain each of the following sources in accordance with manufacturer specifications and with good operating practices to limit VOC emissions, and shall also limit the VOC emission from each of the following sources to less than 2.7 tpy on a 12-month rolling total:

- i. Source 214
- ii. Source 603
- iii. Source 604
- iv. The aggregate of Concasting Sources 133A, 156A, 182A, 404, 508

DDD for Sources 602 & 608

1) In accordance with 25 Pa. Code 129.96(a)-(b), the RACT 2 Rule does not apply to an emission source for which a requirement and/or emissions limitation has been established in 25 PA Code 129.51-129.52c, 129.54-129.69, 129.71-129.73, 129.75, 129.77, 129.101-129.107 and 129.301-129.310. The Lead-Acid Battery Manufacturing Campus contains Source 602 (Cold Cleaners) subject to 25 PA Code 129.63 and Source 608 (Gasoline and Diesel Handling) subject to 25 PA Code 129.61. Therefore, Sources 602 and 608 are not subject to the RACT 2 Rule.

Note: Upon approval of the presumptive RACT 3 requirements in Group SG20 as a SIP revision, the conditions above shall be superseded by the presumptive RACT 3 requirements in SG20, except for the 2.7 tpy VOC limits for Sources 214, 603, 604 & the aggregate of Sources 133A, 156A, 182A, 404, 508.

*** **Permit Shield in Effect.** ***

**SECTION E. Source Group Restrictions.**

Group Name: SG10C RACT 2
 Group Description: RACT 2 Case-by-Case

Sources included in this group

ID	Name
213	MISCELLANEOUS CHEM
605	BATTERY FINISHING

I. RESTRICTIONS.

No additional requirements exist except as provided in other sections of this permit including Section B (Title V General Requirements).

II. TESTING REQUIREMENTS.

No additional testing requirements exist except as provided in other sections of this permit including Section B (Title V General Requirements).

III. MONITORING REQUIREMENTS.

No additional monitoring requirements exist except as provided in other sections of this permit including Section B (Title V General Requirements).

IV. RECORDKEEPING REQUIREMENTS.

No additional record keeping requirements exist except as provided in other sections of this permit including Section B (Title V General Requirements).

V. REPORTING REQUIREMENTS.

No additional reporting requirements exist except as provided in other sections of this permit including Section B (Title V General Requirements).

VI. WORK PRACTICE REQUIREMENTS.

No additional work practice requirements exist except as provided in other sections of this permit including Section B (Title V General Requirements).

VII. ADDITIONAL REQUIREMENTS.**# 001 [25 Pa. Code §129.91]****Control of major sources of NOx and VOCs**

In accordance with the alternative RACT evaluation completed per 25 Pa. Code Section 129.99(c), Sources 213 and 605 shall comply with the following case-by-case RACT 2 requirements for VOC:

I. Source 213 – Miscellaneous Chemicals

a.) The permittee shall minimize the VOC emissions from the miscellaneous solvent usage in the following manner:

- i. All solvents shall be stored and transported in closed containers or pipes.
- ii. All rags containing solvent shall be placed into closed storage containers for storage.
- iii. All rags containing solvent shall be placed into sealed containers and disposed of.
- iv. Spills of materials containing VOC shall be minimized and shall be cleaned up immediately with cleaning cloths or alternative approved methods that will minimize the evaporation of VOC into the atmosphere.
- v. Minimize VOC emissions from cleaning of application, storage, mixing, and conveying equipment by ensuring that equipment cleaning is performed without atomizing the cleaning solvent, and all spent solvent is captured in closed containers.
- vi. Where possible, use products subject to 25 Pa. Code 130 - Standards for Products

b.) The permittee shall record the quantity and identity of all VOC-containing materials used in Source 213 on the various sources on a monthly basis. These records shall be maintained and shall be made part of the permittee's annual "AIMS"

**SECTION E. Source Group Restrictions.**

report to the Department. The records shall be compiled into a monthly and 12-month rolling total format.

c.) Manufacturer supplied VOC data sheets for all coatings and cleaning agents applied within the most recent five (5) years shall be maintained at the facility and be made available to the Department at any time upon request.

II. Source 605 – Battery Finishing

a.) The permittee shall minimize the VOC emissions from the battery finishing operations through the use of good management procedures and standard operating procedures including the following:

- i. Employee training detailing practices to control cleaning solution usage to minimize emissions.
- ii. Controlled distribution of VOC containing cleaning solutions.
- iii. Periodic evaluation of alternative cleaning solutions (i.e. low-VOC or non-VOC materials).
- iv. Good housekeeping procedures for the storage, use, and disposal of cleaning solutions.
- v. Periodic inspection of cleaning solution usage practices and procedures.
- vi. Keeping cleaning solution containers closed when not in use.
- vii. Monitoring, recordkeeping, and reporting of cleaning solution VOC content and usage.

b.) The permittee shall record the quantity and identity of all VOC-containing battery finishing materials used at the facility on a monthly basis. These records shall be maintained and shall be made part of the permittee's annual "AIMS" report to the Department. The records shall be compiled into a monthly and 12-month rolling total format.

c.) Manufacturer supplied VOC data sheets for all coatings and cleaning agents applied within the most recent five (5) years shall be maintained at the facility and be made available to the Department at any time upon request.

Note: Upon approval of the case-by-case RACT 3 requirements in Group SG21 as a SIP revision, the conditions above shall be superseded by the case-by-case RACT 3 requirements in SG21.

***** Permit Shield in Effect. *****

**SECTION E. Source Group Restrictions.**

Group Name: SG11

Group Description: 40 CFR 63 Subpart DDDDD

Sources included in this group

ID	Name
699	5D SOURCES

I. RESTRICTIONS.

No additional requirements exist except as provided in other sections of this permit including Section B (Title V General Requirements).

II. TESTING REQUIREMENTS.

No additional testing requirements exist except as provided in other sections of this permit including Section B (Title V General Requirements).

III. MONITORING REQUIREMENTS.

No additional monitoring requirements exist except as provided in other sections of this permit including Section B (Title V General Requirements).

IV. RECORDKEEPING REQUIREMENTS.

No additional record keeping requirements exist except as provided in other sections of this permit including Section B (Title V General Requirements).

V. REPORTING REQUIREMENTS.

No additional reporting requirements exist except as provided in other sections of this permit including Section B (Title V General Requirements).

VI. WORK PRACTICE REQUIREMENTS.

No additional work practice requirements exist except as provided in other sections of this permit including Section B (Title V General Requirements).

VII. ADDITIONAL REQUIREMENTS.**# 001 [25 Pa. Code §127.441]****Operating permit terms and conditions.**

In the event that the Federal Subpart that is the subject of this Source Group is revised, the permittee shall comply with the revised version of the subpart, and shall not be required to comply with any provisions in this permit designated as having the subpart as their authority, to the extent that such permit provisions would be inconsistent with the applicable provisions of the revised subpart.

002 [25 Pa. Code §127.441]**Operating permit terms and conditions.**

These conditions apply to small natural gas fired boilers and process heaters East Penn Manufacturing operates in its Lyon Station facility. Section H (Miscellaneous) has a list of boilers and process heaters subject to 40 CFR 63 Subpart DDDDD.

003 [40 CFR Part 63 NESHAPS for Source Categories §40 CFR 63.1]**Subpart A--General Provisions****Applicability.**

These sources are subject to 40 CFR Part 63, Subpart DDDDD. The permittee shall comply with 40 CFR 63.13(a), which requires submission of copies of all requests, reports, applications, submittals, and other communications to both the U.S. Environmental Protection Agency (U.S. EPA) and the Department.

The EPA copies shall be forwarded to:

**SECTION E. Source Group Restrictions.**

Associate Director
 United States Environmental Protection Agency
 Region III, Enforcement & Compliance Assurance Division
 Air, RCRA and Toxics Branch (3ED21)
 Four Penn Center
 1600 John F. Kennedy Boulevard
 Philadelphia, Pennsylvania 19103-2852

Unless otherwise approved by DEP, the DEP copies shall be reported through the Department's Greenport PUP system available through: <https://greenport.pa.gov/ePermitPublicAccess/PublicSubmission/Home>

In the event that the Federal Subpart that is the subject of this Source Group is revised, the permittee shall comply with the revised version of the subpart, and shall not be required to comply with any provisions in this permit designated as having the subpart as their authority, to the extent that such permit provisions would be inconsistent with the applicable provisions of the revised subpart.

004 [40 CFR Part 63 NESHAPS for Source Categories §40 CFR 63.7485]**Subpart DDDDD - National Emission Standards for Hazardous Air Pollutants for Major Sources: Industrial, Commercial and Institutional Boilers and Process Heaters.****Am I subject to this subpart?**

§ 63.7480 What is the purpose of this subpart?

This subpart establishes national emission limitations and work practice standards for hazardous air pollutants (HAP) emitted from industrial, commercial, and institutional boilers and process heaters located at major sources of HAP. This subpart also establishes requirements to demonstrate initial and continuous compliance with the emission limitations and work practice standards.

§ 63.7485 Am I subject to this subpart?

You are subject to this subpart if you own or operate an industrial, commercial, or institutional boiler or process heater as defined in § 63.7575 that is located at, or is part of, a major source of HAP, except as specified in § 63.7491. For purposes of this subpart, a major source of HAP is as defined in § 63.2, except that for oil and natural gas production facilities, a major source of HAP is as defined in § 63.7575.

§ 63.7490 What is the affected source of this subpart?

(a) This subpart applies to new, reconstructed, and existing affected sources as described in paragraphs (a)(1) and (2) of this section.

(1) The affected source of this subpart is the collection at a major source of all existing industrial, commercial, and institutional boilers and process heaters within a subcategory as defined in § 63.7575.

(2) The affected source of this subpart is each new or reconstructed industrial, commercial, or institutional boiler or process heater, as defined in § 63.7575, located at a major source.

(b) A boiler or process heater is new if you commence construction of the boiler or process heater after June 4, 2010, and you meet the applicability criteria at the time you commence construction.

(c) A boiler or process heater is reconstructed if you meet the reconstruction criteria as defined in § 63.2, you commence reconstruction after June 4, 2010, and you meet the applicability criteria at the time you commence reconstruction.

(d) A boiler or process heater is existing if it is not new or reconstructed.

(e) An existing electric utility steam generating unit (EGU) that meets the applicability requirements of this subpart after the effective date of this final rule due to a change (e.g., fuel switch) is considered to be an existing source under this subpart.

**SECTION E. Source Group Restrictions.**

§ 63.7491 Are any boilers or process heaters not subject to this subpart?

The types of boilers and process heaters listed in paragraphs (a) through (n) of this section are not subject to this subpart.
[NA – NO EXEMPTIONS APPLY]

(a) [NA – NOT SUBJECT TO 5U]

(b) [NA – NOT SUBJECT TO MM]

(c) [NA – NO R&D UNITS]

(d) [NA – NOT HOT WATER HEATERS]

(e) [NA – NO REFINING KETTLES]

(f) [NA – NOT SUBJECT TO YY]

(g) [NA – NO BLAST FURNACE STOVES]

(h) [NA – NO UNITS PART OF SOURCES SUBJECT TO OTHER PART 63 SUBPART, SUCH AS JJJ, OOO, PPP, U]

(i) [NA – NO UNITS USED AS CONTROL DEVICES]

(j) [NA – NO UNITS DEFINED AS TEMPORARY]

(k) [NA – NO UNITS FIRE BLAST FURNACE GAS]

(l) [NA – NO CAA SECTION 129 UNITS]

(m) [NA – NOT SUBJECT TO EEE]

§ 63.7495 When do I have to comply with this subpart?

(a) If you have a new or reconstructed boiler or process heater, you must comply with this subpart by January 31, 2013, or upon startup of your boiler or process heater, whichever is later.

(b) If you have an existing boiler or process heater, you must comply with this subpart no later than January 31, 2016, except as provided in § 63.6(i).

(c) If you have an area source that increases its emissions or its potential to emit such that it becomes a major source of HAP, paragraphs (c)(1) and (2) of this section apply to you.

(1) Any new or reconstructed boiler or process heater at the existing source must be in compliance with this subpart upon startup.

(2) Any existing boiler or process heater at the existing source must be in compliance with this subpart within 3 years after the source becomes a major source.

(d) You must meet the notification requirements in § 63.7545 according to the schedule in § 63.7545 and in subpart A of this part. Some of the notifications must be submitted before you are required to comply with the emission limits and work practice standards in this subpart.

(e) If you own or operate an industrial, commercial, or institutional boiler or process heater and would be subject to this subpart except for the exemption in § 63.7491(l) for commercial and industrial solid waste incineration units covered by part 60, subpart CCCC or subpart DDDD, and you cease combusting solid waste, you must be in compliance with this subpart on the effective date of the switch from waste to fuel.

**SECTION E. Source Group Restrictions.**

(f) If you own or operate an existing EGU that becomes subject to this subpart after January 31, 2013, you must be in compliance with the applicable existing source provisions of this subpart on the effective date such unit becomes subject to this subpart.

(g) If you own or operate an existing industrial, commercial, or institutional boiler or process heater and would be subject to this subpart except for a exemption in § 63.7491(i) that becomes subject to this subpart after January 31, 2013, you must be in compliance with the applicable existing source provisions of this subpart within 3 years after such unit becomes subject to this subpart.

EDITORIAL NOTE: At 78 FR 7162, Jan. 31, 2013, § 63.7495 was amended by adding paragraph (e). However, there is already a paragraph (e).

005 [40 CFR Part 63 NESHAPS for Source Categories §40 CFR 63.7485]

Subpart DDDDD - National Emission Standards for Hazardous Air Pollutants for Major Sources: Industrial, Commercial and Institutional Boilers and Process Heaters.

Am I subject to this subpart?

Emission Limitations and Work Practice Standards

§ 63.7499 What are the subcategories of boilers and process heaters?

The subcategories of boilers and process heaters, as defined in § 63.7575 are:

- (a) [N/A - UNITS IN THIS SOURCE GROUP ARE NOT FIRED WITH PULVERIZED COAL]
- (b) [N/A - UNITS IN THIS SOURCE GROUP ARE FIRED WITH NATURAL GAS OR PROPANE-AIR MIXTURE]
- (c) [N/A - UNITS IN THIS SOURCE GROUP ARE NOT FIRED WITH FLUIDIZED BED COAL]
- (d) – (j) [N/A - UNITS IN THIS SOURCE GROUP ARE NOT FIRED WITH BIOMASS]
- (k) [N/A - UNITS ARE NOT NON-CONTINENTAL]
- (l) Units designed to burn gas 1 fuels.
- (m) [N/A - UNITS IN THIS SOURCE GROUP ARE NOT FIRED WITH "GAS 2"]
- (n) [N/A - UNITS IN THIS SOURCE GROUP ARE NOT METAL PROCESS FURNACES]
- (o) Limited-use boilers and process heaters.
- (p) [N/A - UNITS IN THIS SOURCE GROUP ARE NOT FIRED WITH SOLID FUEL]
- (q) [N/A - UNITS IN THIS SOURCE GROUP ARE FIRED WITH NATURAL GAS OR PROPANE-AIR MIXTURE]
- (r) [N/A - UNITS IN THIS SOURCE GROUP ARE NOT FIRED WITH SOLID FUEL]
- (s) [N/A - UNITS IN THIS SOURCE GROUP ARE NOT FIRED WITH SOLID FUEL]
- (t) [N/A - UNITS IN THIS SOURCE GROUP ARE FIRED WITH NATURAL GAS OR PROPANE-AIR MIXTURE]
- (u) [N/A - UNITS IN THIS SOURCE GROUP ARE FIRED WITH NATURAL GAS OR PROPANE-AIR MIXTURE]

§ 63.7500 What emission limitations, work practice standards, and operating limits must I meet?

(a) You must meet the requirements in paragraphs (a)(1) through (3) of this section, except as provided in paragraphs (b), through (e) of this section. You must meet these requirements at all times the affected unit is operating, except as provided in paragraph (f) of this section.

**SECTION E. Source Group Restrictions.**

(1) You must meet each emission limit and work practice standard in Tables 1 through 3, and 11 through 13 [OF THESE TABLES, ONLY TABLE 3 APPLIES TO THE UNITS IN THIS SOURCE GROUP] to this subpart that applies to your boiler or process heater, for each boiler or process heater at your source, except as provided under § 63.7522. The output-based emission limits, in units of pounds per million Btu of steam output, in Tables 1 or 2 to this subpart are an alternative applicable only to boilers and process heaters that generate steam. The output-based emission limits, in units of pounds per megawatt-hour, in Tables 1 or 2 to this subpart are an alternative applicable only to boilers that generate electricity. If you operate a new boiler or process heater, you can choose to comply with alternative limits as discussed in paragraphs (a)(1)(i) through (a)(1)(iii) of this section, but on or after January 31, 2016, you must comply with the emission limits in Table 1 to this subpart.

RELEVANT DEFINITION: Unit designed to burn gas 1 subcategory includes any boiler or process heater that burns only natural gas, refinery gas, and/or other gas 1 fuels. Gaseous fuel boilers and process heaters that burn liquid fuel for periodic testing of liquid fuel, maintenance, or operator training, not to exceed a combined total of 48 hours during any calendar year, are included in this definition. Gaseous fuel boilers and process heaters that burn liquid fuel during periods of gas curtailment or gas supply interruptions of any duration are also included in this definition.

TABLE 3 REQUIREMENTS

As stated in § 63.7500, you must comply with the following applicable work practice standards:

1. If your unit is a new or existing boiler or process heater with a continuous oxygen trim system that maintains an optimum air to fuel ratio, or a heat input capacity of less than or equal to 5 million Btu per hour in any of the following subcategories: unit designed to burn gas 1; unit designed to burn gas 2 (other); or unit designed to burn light liquid, or a limited use boiler or process heater, you must meet the following: Conduct a tune-up of the boiler or process heater every 5 years as specified in § 63.7540.
2. If your unit is a new or existing boiler or process heater without a continuous oxygen trim system and with heat input capacity of less than 10 million Btu per hour in the unit designed to burn heavy liquid or unit designed to burn solid fuel subcategories; or a new or existing boiler or process heater with heat input capacity of less than 10 million Btu per hour, but greater than 5 million Btu per hour, in any of the following subcategories: unit designed to burn gas 1; unit designed to burn gas 2 (other); or unit designed to burn light liquid, you must meet the following: Conduct a tune-up of the boiler or process heater biennially as specified in § 63.7540.
3. If your unit is a new or existing boiler or process heater without a continuous oxygen trim system and with heat input capacity of 10 million Btu per hour or greater, you must meet the following: Conduct a tune-up of the boiler or process heater annually as specified in § 63.7540. Units in either the Gas 1 or Metal Process Furnace subcategories will conduct this tune-up as a work practice for all regulated emissions under this subpart. Units in all other subcategories will conduct this tune-up as a work practice for dioxins/furans.
4. If your unit is an existing boiler or process heater located at a major source facility, not including limited use units, you must meet the following: Must have a one-time energy assessment performed by a qualified energy assessor. An energy assessment completed on or after January 1, 2008, that meets or is amended to meet the energy assessment requirements in this table, satisfies the energy assessment requirement. A facility that operates under an energy management program compatible with ISO 50001 that includes the affected units also satisfies the energy assessment requirement. The energy assessment must include the following with extent of the evaluation for items a. to e. appropriate for the on-site technical hours listed in § 63.7575:
 - a. A visual inspection of the boiler or process heater system.
 - b. An evaluation of operating characteristics of the boiler or process heater systems, specifications of energy using systems, operating and maintenance procedures, and unusual operating constraints.
 - c. An inventory of major energy use systems consuming energy from affected boilers and process heaters and which are under the control of the boiler/process heater owner/operator.
 - d. A review of available architectural and engineering plans, facility operation and maintenance procedures and logs, and fuel usage.

**SECTION E. Source Group Restrictions.**

- e. A review of the facility's energy management practices and provide recommendations for improvements consistent with the definition of energy management practices, if identified.
- f. A list of cost-effective energy conservation measures that are within the facility's control.
- g. A list of the energy savings potential of the energy conservation measures identified.
- h. A comprehensive report detailing the ways to improve efficiency, the cost of specific improvements, benefits, and the time frame for recouping those investments.

END OF TABLE 3 REQUIREMENTS

(a)(i) – (iii) [NA – NO EMISSION STANDARDS]

(2) [NA – NO EMISSION STANDARDS]

(3) At all times, you must operate and maintain any affected source (as defined in § 63.7490), including associated air pollution control equipment and monitoring equipment, in a manner consistent with safety and good air pollution control practices for minimizing emissions. Determination of whether such operation and maintenance procedures are being used will be based on information available to the Administrator that may include, but is not limited to, monitoring results, review of operation and maintenance procedures, review of operation and maintenance records, and inspection of the source.

(b) As provided in § 63.6(g), EPA may approve use of an alternative to the work practice standards in this section.

RELEVANT DEFINITION: Limited-use boiler or process heater means any boiler or process heater that burns any amount of solid, liquid, or gaseous fuels and has a federally enforceable average annual capacity factor of no more than 10 percent.

(c) Limited-use boilers and process heaters must complete a tune-up every 5 years as specified in § 63.7540. They are not subject to the emission limits in Tables 1 and 2 or 11 through 13 to this subpart, the annual tune-up, or the energy assessment requirements in Table 3 to this subpart, or the operating limits in Table 4 to this subpart.

(d) Boilers and process heaters with a heat input capacity of less than or equal to 5 million Btu per hour in the units designed to burn gas 2 (other) fuels subcategory or units designed to burn light liquid fuels subcategory must complete a tune-up every 5 years as specified in § 63.7540.

(e) Boilers and process heaters in the units designed to burn gas 1 fuels subcategory with a heat input capacity of less than or equal to 5 million Btu per hour must complete a tune-up every 5 years as specified in § 63.7540. Boilers and process heaters in the units designed to burn gas 1 fuels subcategory with a heat input capacity greater than 5 million Btu per hour and less than 10 million Btu per hour must complete a tune-up every 2 years as specified in § 63.7540. Boilers and process heaters in the units designed to burn gas 1 fuels subcategory are not subject to the emission limits in Tables 1 and 2 or 11 through 13 to this subpart, or the operating limits in Table 4 to this subpart.

(f) These standards apply at all times the affected unit is operating, except during periods of startup and shutdown during which time you must comply only with Table 3 to this subpart.

§ 63.7501 Affirmative Defense for Violation of Emission Standards During Malfunction.

[NA – NO EMISSION STANDARDS]

General Compliance Requirements

§ 63.7505 What are my general requirements for complying with this subpart?

(a) You must be in compliance with the emission limits, work practice standards, and operating limits in this subpart. These limits apply to you at all times the affected unit is operating except for the periods noted in § 63.7500(f).

(b) [Reserved]

**SECTION E. Source Group Restrictions.**

(c) [NA – NO EMISSION STANDARDS]

(d) [NA – NO EMISSION STANDARDS]

006 [40 CFR Part 63 NESHAPS for Source Categories §40 CFR 63.7485]**Subpart DDDDD - National Emission Standards for Hazardous Air Pollutants for Major Sources: Industrial, Commercial and Institutional Boilers and Process Heaters.****Am I subject to this subpart?**

Notification, Reports, and Records

§ 63.7545 What notifications must I submit and when?

(a) You must submit to the Administrator all of the notifications in §§ 63.7(b) and (c), 63.8(e), (f)(4) and (6), and 63.9(b) through (h) that apply to you by the dates specified.

(b) As specified in § 63.9(b)(2), if you startup your affected source before January 31, 2013, you must submit an Initial Notification not later than 120 days after January 31, 2013, or no later than 120 days after the source becomes subject to this subpart, whichever is later.

(c) As specified in § 63.9(b)(4) and (5), if you startup your new or reconstructed affected source on or after January 31, 2013, you must submit an Initial Notification not later than 15 days after the actual date of startup of the affected source. For a new or reconstructed affected source that has reclassified to major source status, you must submit an Initial Notification not later than 120 days after the source becomes subject to this subpart.

(d) [NA – PERFORMANCE TESTING NOT REQUIRED]

(e) If you are required to conduct an initial compliance demonstration as specified in § 63.7530, you must submit a Notification of Compliance Status according to § 63.9(h)(2)(ii). For the initial compliance demonstration for each boiler or process heater, you must submit the Notification of Compliance Status, including all performance test results and fuel analyses, before the close of business on the 60th day following the completion of all performance test and/or other initial compliance demonstrations for all boiler or process heaters at the facility according to § 63.10(d)(2). The Notification of Compliance Status report must contain all the information specified in paragraphs (e)(1) through (8) of this section, as applicable. If you are not required to conduct an initial compliance demonstration as specified in § 63.7530(a), the Notification of Compliance Status must only contain the information specified in paragraphs (e)(1) and (8) of this section and must be submitted within 60 days of the compliance date specified at § 63.7495(b).

(1) A description of the affected unit(s) including identification of which subcategories the unit is in, the design heat input capacity of the unit, a description of the add-on controls used on the unit to comply with this subpart, description of the fuel(s) burned, including whether the fuel(s) were a secondary material determined by you or the EPA through a petition process to be a non-waste under § 241.3 of this chapter, whether the fuel(s) were a secondary material processed from discarded non-hazardous secondary materials within the meaning of § 241.3 of this chapter, and justification for the selection of fuel(s) burned during the compliance demonstration.

(2) [NA – NO EMISSION STANDARDS]

(3) [NA – NO EMISSION STANDARDS]

(4) [NA – NO EMISSION STANDARDS]

(5) [NA – NO EMISSION STANDARDS]

(6) A signed certification that you have met all applicable emission limits and work practice standards.

(7) If you had a deviation from any emission limit, work practice standard, or operating limit, you must also submit a description of the deviation, the duration of the deviation, and the corrective action taken in the Notification of Compliance Status report.

**SECTION E. Source Group Restrictions.**

(8) In addition to the information required in § 63.9(h)(2), your notification of compliance status must include the following certification(s) of compliance, as applicable, and signed by a responsible official:

(i) "This facility completed the required initial tune-up for all of the boilers and process heaters covered by 40 CFR part 63 subpart DDDDD at this site according to the procedures in § 63.7540(a)(10)(i) through (vi)."

(ii) "This facility has had an energy assessment performed according to § 63.7530(e)."

(iii) Except for units that burn only natural gas, refinery gas, or other gas 1 fuel, or units that qualify for a statutory exemption as provided in section 129(g)(1) of the Clean Air Act, include the following: "No secondary materials that are solid waste were combusted in any affected unit."

(f) If you operate a unit designed to burn natural gas, refinery gas, or other gas 1 fuels that is subject to this subpart, and you intend to use a fuel other than natural gas, refinery gas, gaseous fuel subject to another subpart of this part, part 60, 61, or 65, or other gas 1 fuel to fire the affected unit during a period of natural gas curtailment or supply interruption, as defined in § 63.7575, you must submit a notification of alternative fuel use within 48 hours of the declaration of each period of natural gas curtailment or supply interruption, as defined in § 63.7575. The notification must include the information specified in paragraphs (f)(1) through (5) of this section.

(1) Company name and address.

(2) Identification of the affected unit.

(3) Reason you are unable to use natural gas or equivalent fuel, including the date when the natural gas curtailment was declared or the natural gas supply interruption began.

(4) Type of alternative fuel that you intend to use.

(5) Dates when the alternative fuel use is expected to begin and end.

(g) [NA - UNITS IN THIS GROUP DO NOT BURN SOLID WASTE]

(h) If you have switched fuels or made a physical change to the boiler or process heater and the fuel switch or physical change resulted in the applicability of a different subcategory, you must provide notice of the date upon which you switched fuels or made the physical change within 30 days of the switch/change. The notification must identify:

(1) The name of the owner or operator of the affected source, as defined in § 63.7490, the location of the source, the boiler(s) and process heater(s) that have switched fuels, were physically changed, and the date of the notice.

(2) The currently applicable subcategory under this subpart.

(3) The date upon which the fuel switch or physical change occurred.

§ 63.7550 What reports must I submit and when?

(a) You must submit each report in Table 9 to this subpart that applies to you.

TABLE 9 REQUIREMENTS

As stated in § 63.7550, you must comply with the following requirements for reports:

You must submit a compliance report. The report must contain

a. Information required in § 63.7550(c)(1) through (5); and

b. If there are no deviations from any emission limitation (emission limit and operating limit) that applies to you and there are no deviations from the requirements for work practice standards in Table 3 to this subpart that apply to you, a statement

**SECTION E. Source Group Restrictions.**

that there were no deviations from the emission limitations and work practice standards during the reporting period. If there were no periods during which the CMSs, including continuous emissions monitoring system, continuous opacity monitoring system, and operating parameter monitoring systems, were out-of-control as specified in § 63.8(c)(7), a statement that there were no periods during which the CMSs were out-of-control during the reporting period; and

c. If you have a deviation from any emission limitation (emission limit and operating limit) where you are not using a CMS to comply with that emission limit or operating limit, or a deviation from a work practice standard during the reporting period, the report must contain the information in § 63.7550(d); and

d. [NA – NO EMISSION STANDARDS]

You must submit the report semiannually, annually, biennially, or every 5 years according to the requirements in § 63.7550(b).

END OF TABLE 9 REQUIREMENTS

(b) Unless the EPA Administrator has approved a different schedule for submission of reports under § 63.10(a), you must submit each report, according to paragraph (h) of this section, by the date in Table 9 to this subpart and according to the requirements in paragraphs (b)(1) through (4) of this section. For units that are subject only to a requirement to conduct an annual, biennial, or 5-year tune-up according to § 63.7540(a)(10), (11), or (12), respectively, and not subject to emission limits or operating limits, you may submit only an annual, biennial, or 5-year compliance report, as applicable, as specified in paragraphs (b)(1) through (4) of this section, instead of a semi-annual compliance report.

(1) The first compliance report must cover the period beginning on the compliance date that is specified for each boiler or process heater in § 63.7495 and ending on July 31 or January 31, whichever date is the first date that occurs at least 180 days (or 1, 2, or 5 years, as applicable, if submitting an annual, biennial, or 5-year compliance report) after the compliance date that is specified for your source in § 63.7495.

(2) The first compliance report must be postmarked or submitted no later than July 31 or January 31, whichever date is the first date following the end of the first calendar half after the compliance date that is specified for each boiler or process heater in § 63.7495. The first annual, biennial, or 5-year compliance report must be postmarked or submitted no later than January 31.

(3) Each subsequent compliance report must cover the semiannual reporting period from January 1 through June 30 or the semiannual reporting period from July 1 through December 31. Annual, biennial, and 5-year compliance reports must cover the applicable 1-, 2-, or 5-year periods from January 1 to December 31.

(4) Each subsequent compliance report must be postmarked or submitted no later than July 31 or January 31, whichever date is the first date following the end of the semiannual reporting period. Annual, biennial, and 5-year compliance reports must be postmarked or submitted no later than January 31.

(c) A compliance report must contain the following information depending on how the facility chooses to comply with the limits set in this rule.

(1) If the facility is subject to the requirements of a tune up they must submit a compliance report with the information in paragraphs (c)(5)(i) through (iv) and (xiv) of this section.

(2) [NA – FUEL ANALYSES NOT REQUIRED]

(3) [NA – NO EMISSION STANDARDS]

(4) [NA – NO EMISSION STANDARDS]

(5)(i) Company and Facility name and address.

(ii) Process unit information, emissions limitations, and operating parameter limitations.

**SECTION E. Source Group Restrictions.**

(iii) Date of report and beginning and ending dates of the reporting period.

(iv) The total operating time during the reporting period.

(v) – (xiii) [NA – NO EMISSION STANDARDS]

(xiv) Include the date of the most recent tune-up for each unit subject to only the requirement to conduct an annual, biennial, or 5-year tune-up according to § 63.7540(a)(10), (11), or (12) respectively. Include the date of the most recent burner inspection if it was not done annually, biennially, or on a 5-year period and was delayed until the next scheduled or unscheduled unit shutdown.

(xv) – (xvii) [NA – NO EMISSION STANDARDS]

(d) [NA – NO EMISSION STANDARDS]

(e) [NA – NO EMISSION STANDARDS]

(f)-(g) [Reserved]

(h) You must submit the reports according to the procedures specified in paragraphs (h)(1) through (3) of this section.

(1) [NA – NO EMISSION STANDARDS]

(2) [NA – NO EMISSION STANDARDS]

(3) You must submit all reports required by Table 9 of this subpart electronically using CEDRI that is accessed through the EPA's Central Data Exchange (CDX) (www.epa.gov/cdx). However, if the reporting form specific to this subpart is not available in CEDRI at the time that the report is due the report you must submit the report to the Administrator at the appropriate address listed in § 63.13. At the discretion of the Administrator, you must also submit these reports, to the Administrator in the format specified by the Administrator.

§ 63.7555 What records must I keep?

(a) You must keep records according to paragraphs (a)(1) and (2) of this section.

(1) A copy of each notification and report that you submitted to comply with this subpart, including all documentation supporting any Initial Notification or Notification of Compliance Status or semiannual compliance report that you submitted, according to the requirements in § 63.10(b)(2)(xiv).

(2) Records of performance tests, fuel analyses, or other compliance demonstrations and performance evaluations as required in § 63.10(b)(2)(viii).

(b) [NA – NO EMISSION STANDARDS]

(c) [NA – NO EMISSION STANDARDS]

(d) [NA – NO EMISSION STANDARDS]

(e) [NA – NO EMISSION STANDARDS]

(f) [NA – NO EMISSION STANDARDS]

(g) [NA – NO EMISSION STANDARDS]

(h) If you operate a unit in the unit designed to burn gas 1 subcategory that is subject to this subpart, and you use an alternative fuel other than natural gas, refinery gas, gaseous fuel subject to another subpart under this part, other gas 1 fuel, or gaseous fuel subject to another subpart of this part or part 60, 61, or 65, you must keep records of the total hours per

**SECTION E. Source Group Restrictions.**

calendar year that alternative fuel is burned and the total hours per calendar year that the unit operated during periods of gas curtailment or gas supply emergencies.

(i) You must maintain records of the calendar date, time, occurrence and duration of each startup and shutdown.

(j) You must maintain records of the type(s) and amount(s) of fuels used during each startup and shutdown.

§ 63.7560 In what form and how long must I keep my records?

(a) Your records must be in a form suitable and readily available for expeditious review, according to § 63.10(b)(1).

(b) As specified in § 63.10(b)(1), you must keep each record for 5 years following the date of each occurrence, measurement, maintenance, corrective action, report, or record.

(c) You must keep each record on site, or they must be accessible from on site (for example, through a computer network), for at least 2 years after the date of each occurrence, measurement, maintenance, corrective action, report, or record, according to § 63.10(b)(1). You can keep the records off site for the remaining 3 years.

Other Requirements and Information

§ 63.7565 What parts of the General Provisions apply to me?

Table 10 to this subpart shows which parts of the General Provisions in §§ 63.1 through 63.15 apply to you.

007 [40 CFR Part 63 NESHAPS for Source Categories §40 CFR 63.7485]

Subpart DDDDD - National Emission Standards for Hazardous Air Pollutants for Major Sources: Industrial, Commercial and Institutional Boilers and Process Heaters.

Am I subject to this subpart?

Testing, Fuel Analyses, and Initial Compliance Requirements

§ 63.7510 What are my initial compliance requirements and by what date must I conduct them?

(a) [NA – NO EMISSION STANDARDS]

(b) [NA – NO EMISSION STANDARDS]

(c) [NA – NO EMISSION STANDARDS]

(d) [NA – NO EMISSION STANDARDS]

(e) For existing affected sources (as defined in § 63.7490), you must complete the initial compliance demonstration, as specified in paragraphs (a) through (d) of this section, no later than 180 days after the compliance date that is specified for your source in § 63.7495 and according to the applicable provisions in § 63.7(a)(2) as cited in Table 10 to this subpart, except as specified in paragraph (j) of this section. You must complete an initial tune-up by following the procedures described in § 63.7540(a)(10)(i) through (vi) no later than the compliance date specified in § 63.7495, except as specified in paragraph (j) of this section. You must complete the one-time energy assessment specified in Table 3 to this subpart no later than the compliance date specified in § 63.7495, except as specified in paragraph (j) of this section.

(f) [NA – NO EMISSION STANDARDS]

(g) For new or reconstructed affected sources (as defined in § 63.7490), you must demonstrate initial compliance with the applicable work practice standards in Table 3 to this subpart within the applicable annual, biennial, or 5-year schedule as specified in § 63.7540(a) following the initial compliance date specified in § 63.7495(a). Thereafter, you are required to complete the applicable annual, biennial, or 5-year tune-up as specified in § 63.7540(a).

(h) [NA – SOURCES IN THIS GROUP HAVE NOT BURNED SOLID WASTE]

**SECTION E. Source Group Restrictions.**

(i) [NA – NO EGU'S]

(j) For existing affected sources (as defined in § 63.7490) that have not operated between the effective date of the rule and the compliance date that is specified for your source in § 63.7495, you must complete the initial compliance demonstration, if subject to the emission limits in Table 2 to this subpart, as specified in paragraphs (a) through (d) of this section, no later than 180 days after the re-start of the affected source and according to the applicable provisions in § 63.7(a)(2) as cited in Table 10 to this subpart. You must complete an initial tune-up by following the procedures described in § 63.7540(a)(10)(i) through (vi) no later than 30 days after the re-start of the affected source and, if applicable, complete the one-time energy assessment specified in Table 3 to this subpart, no later than the compliance date specified in § 63.7495.

[78 FR 7164, Jan. 31, 2013]

§ 63.7515 When must I conduct subsequent performance tests, fuel analyses, or tune-ups?

(a) [NA – PERFORMANCE TESTING NOT REQUIRED]

(b) [NA – PERFORMANCE TESTING NOT REQUIRED]

(c) [NA – PERFORMANCE TESTING NOT REQUIRED]

(d) If you are required to meet an applicable tune-up work practice standard, you must conduct an annual, biennial, or 5-year performance tune-up according to § 63.7540(a)(10), (11), or (12), respectively. Each annual tune-up specified in § 63.7540(a)(10) must be no more than 13 months after the previous tune-up. Each biennial tune-up specified in § 63.7540(a)(11) must be conducted no more than 25 months after the previous tune-up. Each 5-year tune-up specified in § 63.7540(a)(12) must be conducted no more than 61 months after the previous tune-up. For a new or reconstructed affected source (as defined in § 63.7490), the first annual, biennial, or 5-year tune-up must be no later than 13 months, 25 months, or 61 months, respectively, after the initial startup of the new or reconstructed affected source.

(e) [NA – FUEL ANALYSIS NOT REQUIRED]

(f) [NA – PERFORMANCE TESTING/FUEL ANALYSIS NOT REQUIRED]

(g) For affected sources (as defined in § 63.7490) that have not operated since the previous compliance demonstration and more than one year has passed since the previous compliance demonstration, you must complete the subsequent compliance demonstration, if subject to the emission limits in Tables 1, 2, or 11 through 13 to this subpart, no later than 180 days after the re-start of the affected source and according to the applicable provisions in § 63.7(a)(2) as cited in Table 10 to this subpart. You must complete a subsequent tune-up by following the procedures described in § 63.7540(a)(10)(i) through (vi) and the schedule described in § 63.7540(a)(13) for units that are not operating at the time of their scheduled tune-up.

(h) [NA – PERFORMANCE TESTING NOT REQUIRED]

(i) [NA – NO CO CEMS]

[78 FR 7165, Jan. 31, 2013]

§ 63.7520 What stack tests and procedures must I use?

(a) – (f) [NA – PERFORMANCE TESTING NOT REQUIRED]

§ 63.7521 What fuel analyses, fuel specification, and procedures must I use?

(a) – (i) [NA – FUEL ANALYSIS NOT REQUIRED SINCE NO EMISSION STANDARDS]

§ 63.7522 Can I use emissions averaging to comply with this subpart?

(a) – (k) [NA – NO EMISSION STANDARDS]

**SECTION E. Source Group Restrictions.**

§ 63.7525 What are my monitoring, installation, operation, and maintenance requirements?

- (a) [NA – NO EMISSION STANDARDS]
- (b) [NA – NO EMISSION STANDARDS]
- (c) [NA – NO EMISSION STANDARDS]
- (d) [NA – NO CMS REQUIRED]
- (e) [NA – NO FLOW MONITORING SYSTEM REQUIRED]
- (f) [NA – NO PRESSURE MONITORING SYSTEM REQUIRED]
- (g) [NA – NO PH MONITORING SYSTEM REQUIRED]
- (h) [NA – NO ESP]
- (i) [NA – NO SORBENT INJECTION RATE MONITORING SYSTEM]
- (j) [NA – NO BLDS]
- (k) For each unit that meets the definition of limited-use boiler or process heater, you must keep fuel use records for the days the boiler or process heater was operating.
- (l) [NA – NO EMISSION STANDARDS]
- (m) [NA – NO EMISSION STANDARDS]

§ 63.7530 How do I demonstrate initial compliance with the emission limitations, fuel specifications and work practice standards?

- (a) [NA – NO EMISSION STANDARDS]
- (b) [NA – NO EMISSION STANDARDS]
- (c) [NA – NO EMISSION STANDARDS]
- (d) If you own or operate an existing unit with a heat input capacity of less than 10 million Btu per hour or a unit in the unit designed to burn gas 1 subcategory, you must submit a signed statement in the Notification of Compliance Status report that indicates that you conducted a tune-up of the unit.
- (e) You must include with the Notification of Compliance Status a signed certification that the energy assessment was completed according to Table 3 to this subpart and is an accurate depiction of your facility at the time of the assessment.
- (f) You must submit the Notification of Compliance Status containing the results of the initial compliance demonstration according to the requirements in § 63.7545(e).
- (g) [NA – UNITS TO NOT USE “OTHER GAS 1 FUEL”]
- (h) [NA – NO EMISSION STANDARDS]
- (i) [NA – NO EMISSION STANDARDS]

§ 63.7533 Can I use efficiency credits earned from implementation of energy conservation measures to comply with this subpart?

**SECTION E. Source Group Restrictions.**

(a) – (g) [NA – NO EMISSION STANDARDS]

Continuous Compliance Requirements

§ 63.7535 Is there a minimum amount of monitoring data I must obtain?

(a) - (c) [NA – NO CMS REQUIRED]

§ 63.7540 How do I demonstrate continuous compliance with the emission limitations, fuel specifications and work practice standards?

(a) You must demonstrate continuous compliance with each emission limit in Tables 1 and 2 or 11 through 13 to this subpart, the work practice standards in Table 3 to this subpart, and the operating limits in Table 4 to this subpart that applies to you according to the methods specified in Table 8 to this subpart and paragraphs (a)(1) through (19) of this section.

(1) [NA – NO EMISSION STANDARDS]

(2) As specified in § 63.7550(c), you must keep records of the type and amount of all fuels burned in each boiler or process heater during the reporting period to demonstrate that all fuel types and mixtures of fuels burned would result in either of the following:

(i) – (ii) [NA – NO EMISSION STANDARDS]

(3) [NA – NO EMISSION STANDARDS]

(4) [NA – NO EMISSION STANDARDS]

(5) [NA – NO EMISSION STANDARDS]

(6) [NA – NO EMISSION STANDARDS]

(7) [NA – NO EMISSION STANDARDS]

(8) [NA – NO EMISSION STANDARDS]

(9) [NA – NO EMISSION STANDARDS]

(10) If your boiler or process heater has a heat input capacity of 10 million Btu per hour or greater, you must conduct an annual tune-up of the boiler or process heater to demonstrate continuous compliance as specified in paragraphs (a)(10)(i) through (vi) of this section. This frequency does not apply to limited-use boilers and process heaters, as defined in § 63.7575, or units with continuous oxygen trim systems that maintain an optimum air to fuel ratio.

(i) As applicable, inspect the burner, and clean or replace any components of the burner as necessary (you may delay the burner inspection until the next scheduled unit shutdown). Units that produce electricity for sale may delay the burner inspection until the first outage, not to exceed 36 months from the previous inspection. At units where entry into a piece of process equipment or into a storage vessel is required to complete the tune-up inspections, inspections are required only during planned entries into the storage vessel or process equipment;

(ii) Inspect the flame pattern, as applicable, and adjust the burner as necessary to optimize the flame pattern. The adjustment should be consistent with the manufacturer's specifications, if available;

(iii) Inspect the system controlling the air-to-fuel ratio, as applicable, and ensure that it is correctly calibrated and functioning properly (you may delay the inspection until the next scheduled unit shutdown). Units that produce electricity for sale may delay the inspection until the first outage, not to exceed 36 months from the previous inspection;

(iv) Optimize total emissions of CO. This optimization should be consistent with the manufacturer's specifications, if

**SECTION E. Source Group Restrictions.**

available, and with any NOX requirement to which the unit is subject;

(v) Measure the concentrations in the effluent stream of CO in parts per million, by volume, and oxygen in volume percent, before and after the adjustments are made (measurements may be either on a dry or wet basis, as long as it is the same basis before and after the adjustments are made). Measurements may be taken using a portable CO analyzer; and

(vi) Maintain on-site and submit, if requested by the Administrator, an annual report containing the information in paragraphs (a)(10)(vi)(A) through (C) of this section,

(A) The concentrations of CO in the effluent stream in parts per million by volume, and oxygen in volume percent, measured at high fire or typical operating load, before and after the tune-up of the boiler or process heater;

(B) A description of any corrective actions taken as a part of the tune-up; and

(C) The type and amount of fuel used over the 12 months prior to the tune-up, but only if the unit was physically and legally capable of using more than one type of fuel during that period. Units sharing a fuel meter may estimate the fuel used by each unit.

(11) If your boiler or process heater has a heat input capacity of less than 10 million Btu per hour (except as specified in paragraph (a)(12) of this section), you must conduct a biennial tune-up of the boiler or process heater as specified in paragraphs (a)(10)(i) through (vi) of this section to demonstrate continuous compliance.

(12) If your boiler or process heater has a continuous oxygen trim system that maintains an optimum air to fuel ratio, or a heat input capacity of less than or equal to 5 million Btu per hour and the unit is in the units designed to burn gas 1; units designed to burn gas 2 (other); or units designed to burn light liquid subcategories, or meets the definition of limited-use boiler or process heater in § 63.7575, you must conduct a tune-up of the boiler or process heater every 5 years as specified in paragraphs (a)(10)(i) through (vi) of this section to demonstrate continuous compliance. You may delay the burner inspection specified in paragraph (a)(10)(i) of this section until the next scheduled or unscheduled unit shutdown, but you must inspect each burner at least once every 72 months.

(13) If the unit is not operating on the required date for a tune-up, the tune-up must be conducted within 30 calendar days of startup.

(14) [NA – NO EMISSION STANDARDS]

(15) [NA – NO EMISSION STANDARDS]

(16) [NA – NO EMISSION STANDARDS]

(17) [NA – NO EMISSION STANDARDS]

(18) [NA – NO EMISSION STANDARDS]

(19) [NA – NO EMISSION STANDARDS]

(b) You must report each instance in which you did not meet each emission limit and operating limit in Tables 1 through 4 or 11 through 13 to this subpart that apply to you. These instances are deviations from the emission limits or operating limits, respectively, in this subpart. These deviations must be reported according to the requirements in § 63.7550.

(c) [NA – NO EMISSION STANDARDS]

(d) [NA – NO EMISSION STANDARDS]

[78 FR 7179, Jan. 31, 2013]

[Back to Top](#)



SECTION E. Source Group Restrictions.

§ 63.7541 How do I demonstrate continuous compliance under the emissions averaging provision?

(a) – (b) [NA – NO EMISSION STANDARDS]

***** Permit Shield in Effect. *****

**SECTION E. Source Group Restrictions.**

Group Name: SG12 BAGHOUSE CAM

Group Description: CAM for Baghouses with or without HEPA

Sources included in this group

ID	Name
111	A-1 MIXING (SCIEN FC 1) & PASTING (FARR CC 4)
112	A-1 DRY CHARGE AREA (SCIEN FC 7, SCIEN FC 6 & FARR CC 4)
113	A-1 GRIDCAST (SCIEN FC 6 & SCIEN FC 5)
114	A-1 BATTERY ASSM (FARR CC 4, SCIEN FC 6 & FC 7)
130	A-2 BATTERY ASSEMBLY C (SCIENTIFIC FC 2)
131	A-2 MIXING (SCIEN FC 9) & PASTING (SCIEN FC 2 & 6)
132	A-2 COS & ENVELOPE (SCIEN FC 1 & SCIEN FC 10)
133	A-2 GRIDCAST (SCIEN FC 7, 2 & 10 & SCIEN FC 1)
133A	A-2 CONCASTER (SCIEN FC #1 & SCIEN FC #10)
133E	A-2 STRIP/PUNCHCAST MACH #1-3 (SCIEN FC 1)
134	A-2 ASSEMBLY (SCIENTIFIC FC 8)
138	A-2 BATT ASMBLY (FARR CC 3)
140	A-2 BATT ASMBLY D (FARR CC 4)
143	IND GRIDCASTING (SCIEN #3)
146	IND MIX (SCIEN #2) & PASTE (CARB #1)
147	IND BATT ASSY/DRY CHARGE/FORM SUPP (SCIEN #4)
148	IND BATT ASSEMBLY (SCIEN #5)
149	IND FORMING ROOM & WET CHARGE (4 MIST ELIM)
150	IND BATTERY BOOST (4 MIST ELIM)
151	A-3 PASTE MIXING (SCIENTIFIC FC #6)
152	A-3 BATTERY ASSEMBLY (SCIENTIFIC CC #1)
153	A-3 COS & ENVELOPE A (SCIENTIFIC FC #2)
156	A-3 GRIDCAST (SCIENTIFIC FC #6)
156A	A-3 CONCAST (SCIEN FC 6)
157	A-3 COS & ENVELOPE B (SCIENTIFIC FC #3)
158	A-3 COS & ENVELOPE D (SCIENTIFIC FC #4)
159	A-3 COS & STACKING C (SCIENTIFIC FC #5)
179	S-1 BATTERY ASSEMBLY (SCIENTIFIC FC #6)
181	S-1 BATTERY ASSEMBLY & DRY CHARGE (SCIEN FC #3)
182	S-1 GRIDCAST (SCIENTIFIC FC #1)
182A	S-1 CONCAST (SCIENTIFIC FC #1)
183	S-1 GROUP ASSEMBLY (SCIENTIFIC FC #2)
184	S-1 MIXING (SCIENTIFIC FC #1) & PASTING (SCIENTIFIC FC #4)
188	S-1 UNIGY & GEL BATT ASSEM (SCIENTIFIC FC #5)
189	S-1 GROUP ASSEMBLY (SCIENTIFIC FC #4)
192	A-1 BURN & STACK (SCIENTIFIC FC 5)
193	A-2 GROUP ASSEMBLY 1 (SCIENTIFIC FC 5)
194	A-2 GROUP ASSEMBLY 2 (SCIENTIFIC FC 6)
195	A-2 GROUP ASSEMBLY 3 (SCIENTIFIC FC 7)
210	WTP SALT DRYER
211	WTP SALT TRUCK LOADOUT OPERATION
301	S-1A BATT ASSEMBLY ANNEX (SCIENTIFIC FC 6)
402	A-4 MIXING (SCIEN #6) & PASTING (SCIEN #1)

**SECTION E. Source Group Restrictions.**

403	A-4 GRIDCASTING (SCIEN FC #2)
404	A-4 CONCASTING (SCIEN FC #2)
405	A-4 THREE-PROCESS-OPR (FC #3 & #4 & #7)
407	A-4 BATT ASSEMBLY LINES (SCIEN FC #5)
503	A-2 RED LEAD OXIDE STORAGE SILO (BIN VENT)
506	SMALL PARTS CASTING & HYDRACAST
508	A-2 COS/ENVELOPE/CONCAST (SCIEN 10)
720	IND ULTRA BATTERY OPERATIONS
721	IND UNIGY II THREE-PROCESS-OPR
722	IND UNIGY II GRIDCASTING OPR
724	IND AUTO COS #3
728	EQUIPMENT DECONSTRUCTION BUILDING

I. RESTRICTIONS.

No additional requirements exist except as provided in other sections of this permit including Section B (Title V General Requirements).

II. TESTING REQUIREMENTS.

No additional testing requirements exist except as provided in other sections of this permit including Section B (Title V General Requirements).

III. MONITORING REQUIREMENTS.**# 001 [40 CFR Part 64 Compliance Assurance Monitoring for Major Stationary Sources §40 CFR 64.3]****Sections of PART 64****Monitoring design criteria**

[Additional authority for this Compliance Assurance Monitoring (CAM) permit condition is also derived from 40 CFR Part 64, Sections 64.1-64.10]

The following conditions apply to baghouses and to HEPA filters (if applicable) controlling emissions from sources in this source group:

#AAA

(a) The permittee shall use the pressure differential across each baghouse and across each HEPA filter to obtain data and monitor the equipment performance.

(b) The permittee shall operate and maintain magnehelic gauges (or equivalent devices) across each baghouse and each HEPA filter to measure the pressure differential described in (a), above.

(c) The permittee shall monitor the process parameters described in (a), above, once per week for each baghouse and each HEPA filter.

#BBB

(a) The permittee shall maintain records of the following information related to CAM:

(1) All monitor readings and excursions.

(2) all excursions and corrective actions taken in response to an excursion and the time elapsed until the corrective actions have been taken.

(3) all inspections, repairs and maintenance performed on the process parameter monitoring equipment.

**SECTION E. Source Group Restrictions.**

(4) all monitoring equipment down time incidents (other than down time associated with accuracy checks or calibration checks). The permittee shall also record the dates, times and durations, possible causes and corrective actions taken for the incidents.

(5) The number of hours of operation of each source during each six-month reporting period.

(b) The permittee shall keep all records for a period of five (5) years and make the records available to the Department upon request.

#CCC

(a) The permittee shall report all excursions and corrective actions taken, the dates, times, durations and possible causes, every six (6) months.

(b) The permittee shall report all monitoring equipment down time incidents (other than down time associated with accuracy checks or calibration checks), their dates, times and durations, possible causes and corrective actions taken, every six (6) months.

#DDD

(a) The following shall be defined as an excursion:

A departure from the parameter ranges specified in the Section C CAM Range Condition, based on each weekly parameter value shall be defined as an excursion. Failure to perform weekly monitoring/record keeping of any process parameter for less than 90% of the required readings in a reporting period shall also be defined as an excursion.

(b) The permittee shall maintain spare monitoring equipment and related parts on site for routine repairs/replacement.

(c) The permittee shall maintain a supply of spare (replacement) bags for the baghouse(s) covered by this source group.

#EEE

(a) The permittee shall develop and implement a quality improvement plan (QIP) as expeditiously as practicable if any of the following occurs:

(1) Six excursions of any given parameter range occur in a six-month reporting period for an individual fabric dust collector or secondary HEPA filter.

(2) Failure to perform weekly monitoring of any given parameter, for any given fabric filter dust collector or secondary HEPA filter, for less than 90% of the required readings in a reporting period.

(3) The Department determines after review of all reported information that the permittee has not responded acceptably to an excursion.

(b) The QIP should be developed within 60 days of the end of the relevant six-month reporting period, and the permittee shall provide a copy of the QIP to the Department. Furthermore, the permittee shall notify the Department if the period for completing the improvements contained in the QIP exceeds 180 days from the date on which the need to implement the QIP was determined.

(c) The permittee shall record actions taken to implement the QIP during a reporting period and all related actions including, but not limited to inspections, repairs and maintenance performed on the monitoring equipment.

(d) The QIP shall include procedures for evaluating any control device performance problems on such devices associated with the QIP. Based on the results of the evaluation procedures, the permittee shall modify the QIP, and provide a copy to the Department, to include procedures for conducting more frequent or improved monitoring in conjunction with one or more of the following:

(1) Improved preventive maintenance practices.

(2) Process operation changes.

(3) Appropriate improvements to control methods.

**SECTION E. Source Group Restrictions.**

(4) Other steps appropriate to correct performance.

(e) Following implementation of a QIP, the Department will require reasonable revisions to the QIP if the plan has failed to either:

(1) Address the cause of the control device performance problem.

(2) Provide adequate procedures for correcting control device performance problems as expeditiously as practicable in accordance with good air pollution control practices for minimizing emissions.

(f) Implementation of a QIP shall not excuse the owner or operator of a source from compliance with any existing emission limitation or standard or any existing monitoring, testing, reporting or recordkeeping requirement that may apply under any federal, state, or local laws or any other applicable requirements under the Clean Air Act.

IV. RECORDKEEPING REQUIREMENTS.

No additional record keeping requirements exist except as provided in other sections of this permit including Section B (Title V General Requirements).

V. REPORTING REQUIREMENTS.

No additional reporting requirements exist except as provided in other sections of this permit including Section B (Title V General Requirements).

VI. WORK PRACTICE REQUIREMENTS.

No additional work practice requirements exist except as provided in other sections of this permit including Section B (Title V General Requirements).

VII. ADDITIONAL REQUIREMENTS.

No additional requirements exist except as provided in other sections of this permit including Section B (Title V General Requirements).

***** Permit Shield in Effect. *****

**SECTION E. Source Group Restrictions.**

Group Name: SG13 BIN VENT CAM

Group Description: CAM for Bin Vent Dust Collectors

Sources included in this group

ID	Name
136	A-2 LEAD OXIDE STORAGE SILOS (7) (BIN VENTS)
144A	IND LEAD OXIDE STORAGE SILOS (6) (BIN VENTS)
401	A-4 LEAD OXIDE STORAGE SILOS (9) (BIN VENTS)

I. RESTRICTIONS.

No additional requirements exist except as provided in other sections of this permit including Section B (Title V General Requirements).

II. TESTING REQUIREMENTS.

No additional testing requirements exist except as provided in other sections of this permit including Section B (Title V General Requirements).

III. MONITORING REQUIREMENTS.

No additional monitoring requirements exist except as provided in other sections of this permit including Section B (Title V General Requirements).

IV. RECORDKEEPING REQUIREMENTS.

No additional record keeping requirements exist except as provided in other sections of this permit including Section B (Title V General Requirements).

V. REPORTING REQUIREMENTS.

No additional reporting requirements exist except as provided in other sections of this permit including Section B (Title V General Requirements).

VI. WORK PRACTICE REQUIREMENTS.

No additional work practice requirements exist except as provided in other sections of this permit including Section B (Title V General Requirements).

VII. ADDITIONAL REQUIREMENTS.**# 001 [40 CFR Part 64 Compliance Assurance Monitoring for Major Stationary Sources §40 CFR 64.3]****Sections of PART 64****Monitoring design criteria**

[Additional authority for this Compliance Assurance Monitoring (CAM) permit condition is also derived from 40 CFR Part 64, Sections 64.1-64.10]

The following conditions apply to bin vent dust collectors and to HEPA filters (if applicable) controlling emissions from sources in this source group:

#AAA

(a) The permittee shall use the following process parameters to obtain data and monitor the equipment performance:

* Pressure differential across each bin vent dust collector and each HEPA filter.

(b) The permittee shall operate and maintain the following monitoring equipment to measure the process parameters described in (a), above:

* Magnehelic gauges (or equivalent devices) to measure the pressure differential across each bin vent dust collector and each HEPA filter.

**SECTION E. Source Group Restrictions.**

(c) The permittee shall monitor the process parameters described in (a), above, as follows:

* Once per quarter for each bin vent dust collector and each HEPA filter.

#BBB

(a) The permittee shall maintain records of the following information related to CAM:

- (1) All monitor readings and excursions.
- (2) all excursions and corrective actions taken in response to an excursion and the time elapsed until the corrective actions have been taken.
- (3) all inspections, repairs and maintenance performed on the process parameter monitoring equipment.
- (4) all monitoring equipment down time incidents (other than down time associated with accuracy checks or calibration checks). The permittee shall also record the dates, times and durations, possible causes and corrective actions taken for the incidents.
- (5) The number of hours of operation of each source during each six-month reporting period.

(b) The permittee shall keep all records for a period of five (5) years and make the records available to the Department upon request.

#CCC

(a) The permittee shall report all excursions and corrective actions taken, the dates, times, durations and possible causes, every six (6) months.

(b) The permittee shall report all monitoring equipment down time incidents (other than down time associated with accuracy checks or calibration checks), their dates, times and durations, possible causes and corrective actions taken, every six (6) months.

#DDD

(a) The following shall be defined as an excursion:

A departure from the parameter ranges specified in the Section C CAM Range Condition, based on each quarterly parameter value shall be defined as an excursion. Failure to perform quarterly monitoring/record keeping of any process parameter for less than 90% of the required readings in a reporting period shall also be defined as an excursion.

(b) The permittee shall maintain spare monitoring equipment and related parts on site for routine repairs/replacement.

(c) The permittee shall maintain a supply of spare (replacement) bags for the bin vent dust collector(s) covered by this source group.

#EEE

(a) The permittee shall develop and implement a quality improvement plan (QIP) as expeditiously as practicable if any of the following occurs:

- (1) Six excursions of any given parameter range occur in a six-month reporting period for an individual bin vent dust collector or secondary HEPA filter.
- (2) Failure to perform quarterly monitoring of any given parameter, for any given bin vent dust collector or secondary HEPA filter, for less than 90% of the required readings in a reporting period.
- (3) The Department determines after review of all reported information that the permittee has not responded acceptably to an excursion.

(b) The QIP should be developed within 60 days of the end of the relevant six-month reporting period, and the permittee shall provide a copy of the QIP to the Department. Furthermore, the permittee shall notify the Department if the period for completing the improvements contained in the QIP exceeds 180 days from the date on which the need to implement the

**SECTION E. Source Group Restrictions.**

QIP was determined.

(c) The permittee shall record actions taken to implement the QIP during a reporting period and all related actions including, but not limited to inspections, repairs and maintenance performed on the monitoring equipment.

(d) The QIP shall include procedures for evaluating any control device performance problems on such devices associated with the QIP. Based on the results of the evaluation procedures, the permittee shall modify the QIP, and provide a copy to the Department, to include procedures for conducting more frequent or improved monitoring in conjunction with one or more of the following:

- (1) Improved preventive maintenance practices.
- (2) Process operation changes.
- (3) Appropriate improvements to control methods.
- (4) Other steps appropriate to correct performance.

(e) Following implementation of a QIP, the Department will require reasonable revisions to the QIP if the plan has failed to either:

- (1) Address the cause of the control device performance problem.
- (2) Provide adequate procedures for correcting control device performance problems as expeditiously as practicable in accordance with good air pollution control practices for minimizing emissions.

(f) Implementation of a QIP shall not excuse the owner or operator of a source from compliance with any existing emission limitation or standard or any existing monitoring, testing, reporting or recordkeeping requirement that may apply under any federal, state, or local laws or any other applicable requirements under the Clean Air Act.

***** Permit Shield in Effect. *****

**SECTION E. Source Group Restrictions.**

Group Name: SG14 ABSOLENT CAM
 Group Description: CAM for Absolent Fiber Filters

Sources included in this group

ID	Name
141	IND HEATSEAL BOOTH (5)
511	A-1 HEAT SEAL BOOTHS #1-4
513	A-3 HEAT SEAL BOOTHS #1 - 3
514	S-1 HEAT SEAL BOOTHS #1-3
515	MOLDING LID SEAL BOOTHS 1-13: FIBER BEDS OR EQIV
516	A-4 HEAT & LID SEAL BOOTHS 1 - 14: FIBER BEDS OR EQIV CTRL
517	SMELTER ANNEX LID SEALER BOOTHS #1-24
518	IND HEAT SEAL BOOTHS #1 & #2
725	IND AUTO HEAT SEAL

I. RESTRICTIONS.

No additional requirements exist except as provided in other sections of this permit including Section B (Title V General Requirements).

II. TESTING REQUIREMENTS.

No additional testing requirements exist except as provided in other sections of this permit including Section B (Title V General Requirements).

III. MONITORING REQUIREMENTS.

No additional monitoring requirements exist except as provided in other sections of this permit including Section B (Title V General Requirements).

IV. RECORDKEEPING REQUIREMENTS.

No additional record keeping requirements exist except as provided in other sections of this permit including Section B (Title V General Requirements).

V. REPORTING REQUIREMENTS.

No additional reporting requirements exist except as provided in other sections of this permit including Section B (Title V General Requirements).

VI. WORK PRACTICE REQUIREMENTS.

No additional work practice requirements exist except as provided in other sections of this permit including Section B (Title V General Requirements).

VII. ADDITIONAL REQUIREMENTS.**# 001 [40 CFR Part 64 Compliance Assurance Monitoring for Major Stationary Sources §40 CFR 64.3]****Sections of PART 64
Monitoring design criteria**

[Additional authority for this Compliance Assurance Monitoring (CAM) permit condition is also derived from 40 CFR Part 64, Sections 64.1-64.10]

The following conditions apply to Absolent (or equivalent) fiber filters equipped with HEPA filters controlling emissions from sources in this source group:

#AAA

(a) The permittee shall use the following process parameters to obtain data and monitor the equipment performance:

**SECTION E. Source Group Restrictions.**

* Pressure differential across each Fiber Filter and each HEPA filter.

(b) The permittee shall operate and maintain the following monitoring equipment to measure the process parameters described in (a), above:

* Magnehelic gauges (or equivalent devices) to measure the pressure differential across each Fiber Filter and each HEPA filter.

(c) The permittee shall monitor the process parameters described in (a), above, as follows:

* Once per week for each Fiber Filter and each HEPA filter.

#BBB

(a) The permittee shall maintain records of the following information related to CAM:

(1) All monitor readings and excursions.

(2) all excursions and corrective actions taken in response to an excursion and the time elapsed until the corrective actions have been taken.

(3) all inspections, repairs and maintenance performed on the process parameter monitoring equipment.

(4) all monitoring equipment down time incidents (other than down time associated with accuracy checks or calibration checks). The permittee shall also record the dates, times and durations, possible causes and corrective actions taken for the incidents.

(5) The number of hours of operation of each source during each six-month reporting period.

(b) The permittee shall keep all records for a period of five (5) years and make the records available to the Department upon request.

#CCC

(a) The permittee shall report all excursions and corrective actions taken, the dates, times, durations and possible causes, every six (6) months.

(b) The permittee shall report all monitoring equipment down time incidents (other than down time associated with accuracy checks or calibration checks), their dates, times and durations, possible causes and corrective actions taken, every six (6) months.

#DDD

(a) The following shall be defined as an excursion:

A departure from the parameter ranges specified in the Section C CAM Range Condition, based on each weekly parameter value shall be defined as an excursion. Failure to perform weekly monitoring/record keeping of any process parameter for less than 90% of the required readings in a reporting period shall also be defined as an excursion.

(b) The permittee shall maintain spare monitoring equipment and related parts on site for routine repairs/replacement.

(c) The permittee shall maintain a supply of spare (replacement) filters for the Absolent (or equivalent) Fiber Filter(s) covered by this source group.

#EEE

(a) The permittee shall develop and implement a quality improvement plan (QIP) as expeditiously as practicable if any of the following occurs:

(1) Six excursions of any given parameter range occur in a six-month reporting period for an individual fabric dust collector or secondary HEPA filter.

**SECTION E. Source Group Restrictions.**

- (2) Failure to perform weekly monitoring of any given parameter, for any given fabric filter dust collector or secondary HEPA filter, for less than 90% of the required readings in a reporting period.
- (3) The Department determines after review of all reported information that the permittee has not responded acceptably to an excursion.
- (b) The QIP should be developed within 60 days of the end of the relevant six-month reporting period, and the permittee shall provide a copy of the QIP to the Department. Furthermore, the permittee shall notify the Department if the period for completing the improvements contained in the QIP exceeds 180 days from the date on which the need to implement the QIP was determined.
- (c) The permittee shall record actions taken to implement the QIP during a reporting period and all related actions including, but not limited to inspections, repairs and maintenance performed on the monitoring equipment.
- (d) The QIP shall include procedures for evaluating any control device performance problems on such devices associated with the QIP. Based on the results of the evaluation procedures, the permittee shall modify the QIP, and provide a copy to the Department, to include procedures for conducting more frequent or improved monitoring in conjunction with one or more of the following:
- (1) Improved preventive maintenance practices.
 - (2) Process operation changes.
 - (3) Appropriate improvements to control methods.
 - (4) Other steps appropriate to correct performance.
- (e) Following implementation of a QIP, the Department will require reasonable revisions to the QIP if the plan has failed to either:
- (1) Address the cause of the control device performance problem.
 - (2) Provide adequate procedures for correcting control device performance problems as expeditiously as practicable in accordance with good air pollution control practices for minimizing emissions.
- (f) Implementation of a QIP shall not excuse the owner or operator of a source from compliance with any existing emission limitation or standard or any existing monitoring, testing, reporting or recordkeeping requirement that may apply under any federal, state, or local laws or any other applicable requirements under the Clean Air Act.

***** Permit Shield in Effect. *****

**SECTION E. Source Group Restrictions.**

Group Name: SG15 SUBPART JJJJ
 Group Description: Post-2006 Emergency SI RICE
 Sources included in this group

ID	Name
601B	EMERGENCY SI ENGINES POST-2006

I. RESTRICTIONS.

No additional requirements exist except as provided in other sections of this permit including Section B (Title V General Requirements).

II. TESTING REQUIREMENTS.

No additional testing requirements exist except as provided in other sections of this permit including Section B (Title V General Requirements).

III. MONITORING REQUIREMENTS.

No additional monitoring requirements exist except as provided in other sections of this permit including Section B (Title V General Requirements).

IV. RECORDKEEPING REQUIREMENTS.

No additional record keeping requirements exist except as provided in other sections of this permit including Section B (Title V General Requirements).

V. REPORTING REQUIREMENTS.

No additional reporting requirements exist except as provided in other sections of this permit including Section B (Title V General Requirements).

VI. WORK PRACTICE REQUIREMENTS.

No additional work practice requirements exist except as provided in other sections of this permit including Section B (Title V General Requirements).

VII. ADDITIONAL REQUIREMENTS.

**# 001 [40 CFR Part 60 Standards of Performance for New Stationary Sources §40 CFR 60.4230]
 Subpart JJJJ - Standards of Performance for Stationary Spark Ignition Internal Combustion Engines
 Am I subject to this subpart?**

§ 60.4230 Am I subject to this subpart?

(a) The provisions of this subpart are applicable to manufacturers, owners, and operators of stationary spark ignition (SI) internal combustion engines (ICE) as specified in paragraphs (a)(1) through (6) of this section. For the purposes of this subpart, the date that construction commences is the date the engine is ordered by the owner or operator.

(1) [NA - NOT AN ENGINE MANUFACTURER]

(2) [NA - NOT UNITS DO NOT USE GASOLINE OR RICH BURN LPG]

(3) [NA - NOT AN ENGINE MANUFACTURER]

(4) Owners and operators of stationary SI ICE that commence construction after June 12, 2006, where the stationary SI ICE are manufactured:

(i) [NA - UNIT(S) < 500 HP]

(ii) [NA - UNIT(S) < 500 HP]

**SECTION E. Source Group Restrictions.**

- (iii) on or after July 1, 2008, for engines with a maximum engine power less than 500 HP; or
- (iv) on or after January 1, 2009, for emergency engines with a maximum engine power greater than 19 KW (25 HP).
- (5) [NA - UNIT(S) NOT MODIFIED OR RECONSTRUCTED]
- (6) The provisions of § 60.4236 of this subpart are applicable to all owners and operators of stationary SI ICE that commence construction after June 12, 2006.
- (b) [NA - ENGINE TEST CELL NOT RELEVANT HERE]
- (c) If you are an owner or operator of an area source subject to this subpart, you are exempt from the obligation to obtain a permit under 40 CFR part 70 or 40 CFR part 71, provided you are not required to obtain a permit under 40 CFR 70.3(a) or 40 CFR 71.3(a) for a reason other than your status as an area source under this subpart. Notwithstanding the previous sentence, you must continue to comply with the provisions of this subpart as applicable.
- (d) [NA - UNIT(S) DO NOT USE ALCOHOL-BASED FUELS]
- (e) [NA - NO NATIONAL SECURITY EXEMPTION]
- (f) [NA - NOT TEMPORARY REPLACEMENT UNITS]

[73 FR 3591, Jan. 18, 2008, as amended at 76 FR 37972, June 28, 2011; 86 FR 34360, June 29, 2021]

Emission Standards for Owners and Operators

§ 60.4233 What emission standards must I meet if I am an owner or operator of a stationary SI internal combustion engine?

- (a) Owners and operators of stationary SI ICE with a maximum engine power less than or equal to 19 KW (25 HP) manufactured on or after July 1, 2008, must comply with the emission standards in § 60.4231(a) for their stationary SI ICE.
- (b) [NA - UNIT(S) DO NOT BURN GASOLINE]
- (c) [NA - UNIT(S) ARE NOT RICH BURN LPG]
- (d) Owners and operators of stationary SI ICE with a maximum engine power greater than 19 KW (25 HP) and less than 75 KW (100 HP) (except gasoline and rich burn engines that use LPG) must comply with the emission standards for field testing in 40 CFR 1048.101(c) for their non-emergency stationary SI ICE and with the emission standards in Table 1 to this subpart for their emergency stationary SI ICE. Owners and operators of stationary SI ICE with a maximum engine power greater than 19 KW (25 HP) and less than 75 KW (100 HP) manufactured prior to January 1, 2011, that were certified to the standards in Table 1 to this subpart applicable to engines with a maximum engine power greater than or equal to 100 HP and less than 500 HP, may optionally choose to meet those standards.
- (e) Owners and operators of stationary SI ICE with a maximum engine power greater than or equal to 75 KW (100 HP) (except gasoline and rich burn engines that use LPG) must comply with the emission standards in Table 1 to this subpart for their stationary SI ICE. For owners and operators of stationary SI ICE with a maximum engine power greater than or equal to 100 HP (except gasoline and rich burn engines that use LPG) manufactured prior to January 1, 2011 that were certified to the certification emission standards in 40 CFR part 1048 applicable to engines that are not severe duty engines, if such stationary SI ICE was certified to a carbon monoxide (CO) standard above the standard in Table 1 to this subpart, then the owners and operators may meet the CO certification (not field testing) standard for which the engine was certified.
- (f) [NA - UNIT(S) NOT MODIFIED OR RECONSTRUCTED]
- (g) [NA - STATIONARY WELLHEAD GAS NOT USED]
- (h) [NA - EMERGENCY ENGINES NOT REQUIRED TO MEET 40 CFR 1048.101]

**SECTION E. Source Group Restrictions.**

[73 FR 3591, Jan. 18, 2008, as amended at 76 FR 37973, June 28, 2011]

§ 60.4234 How long must I meet the emission standards if I am an owner or operator of a stationary SI internal combustion engine?

Owners and operators of stationary SI ICE must operate and maintain stationary SI ICE that achieve the emission standards as required in § 60.4233 over the entire life of the engine.

Other Requirements for Owners and Operators

§ 60.4235 What fuel requirements must I meet if I am an owner or operator of a stationary SI gasoline fired internal combustion engine subject to this subpart?

[NA - UNIT(S) DO NOT USE GASOLINE]

§ 60.4236 What is the deadline for importing or installing stationary SI ICE produced in previous model years?

(a) After July 1, 2010, owners and operators may not install stationary SI ICE with a maximum engine power of less than 500 HP that do not meet the applicable requirements in § 60.4233.

(b) [NA - UNIT(S) < 500 HP]

(c) For emergency stationary SI ICE with a maximum engine power of greater than 19 KW (25 HP), owners and operators may not install engines that do not meet the applicable requirements in § 60.4233 after January 1, 2011.

(d) [NA - IMPORTATION NOT RELEVANT IN THIS CASE]

(e) The requirements of this section do not apply to owners and operators of stationary SI ICE that have been modified or reconstructed, and they do not apply to engines that were removed from one existing location and reinstalled at a new location.

§ 60.4237 What are the monitoring requirements if I am an owner or operator of an emergency stationary SI internal combustion engine?

(a) [NA - UNIT(S) < 500 HP]

(b) Starting on January 1, 2011, if the emergency stationary SI internal combustion engine that is greater than or equal to 130 HP and less than 500 HP that was built on or after January 1, 2011, does not meet the standards applicable to non-emergency engines, the owner or operator must install a non-resettable hour meter.

(c) If you are an owner or operator of an emergency stationary SI internal combustion engine that is less than 130 HP, was built on or after July 1, 2008, and does not meet the standards applicable to non-emergency engines, you must install a non-resettable hour meter upon startup of your emergency engine.

Compliance Requirements for Owners and Operators

§ 60.4243 What are my compliance requirements if I am an owner or operator of a stationary SI internal combustion engine?

(a) [NA - UNIT(S) NOT SUBJECT TO § 60.4233(a) through (c); NEVERTHELESS, THIS SECTION IS REFERENCED FROM (b)]

If you are an owner or operator of a stationary SI internal combustion engine that is manufactured after July 1, 2008, and must comply with the emission standards specified in § 60.4233(a) through (c), you must comply by purchasing an engine certified to the emission standards in § 60.4231(a) through (c), as applicable, for the same engine class and maximum engine power. In addition, you must meet one of the requirements specified in (a)(1) and (2) of this section.

**SECTION E. Source Group Restrictions.**

(1) If you operate and maintain the certified stationary SI internal combustion engine and control device according to the manufacturer's emission-related written instructions, you must keep records of conducted maintenance to demonstrate compliance, but no performance testing is required if you are an owner or operator. You must also meet the requirements as specified in 40 CFR part 1068, subparts A through D, as they apply to you. If you adjust engine settings according to and consistent with the manufacturer's instructions, your stationary SI internal combustion engine will not be considered out of compliance.

(2) If you do not operate and maintain the certified stationary SI internal combustion engine and control device according to the manufacturer's emission-related written instructions, your engine will be considered a non-certified engine, and you must demonstrate compliance according to (a)(2)(i) through (iii) of this section, as appropriate.

(i) If you are an owner or operator of a stationary SI internal combustion engine less than 100 HP, you must keep a maintenance plan and records of conducted maintenance to demonstrate compliance and must, to the extent practicable, maintain and operate the engine in a manner consistent with good air pollution control practice for minimizing emissions, but no performance testing is required if you are an owner or operator.

(ii) If you are an owner or operator of a stationary SI internal combustion engine greater than or equal to 100 HP and less than or equal to 500 HP, you must keep a maintenance plan and records of conducted maintenance and must, to the extent practicable, maintain and operate the engine in a manner consistent with good air pollution control practice for minimizing emissions. In addition, you must conduct an initial performance test within 1 year of engine startup to demonstrate compliance.

(iii) [NA - UNIT(S) <500 HP]

(b) If you are an owner or operator of a stationary SI internal combustion engine and must comply with the emission standards specified in § 60.4233(d) or (e), you must demonstrate compliance according to one of the methods specified in paragraphs (b)(1) and (2) of this section.

(1) Purchasing an engine certified according to procedures specified in this subpart, for the same model year and demonstrating compliance according to one of the methods specified in paragraph (a) of this section.

(2) [NA - UNIT(S) ARE CERTIFIED]

(c) [NA - UNIT(S) NOT MODIFIED OR RECONSTRUCTED]

(d) If you own or operate an emergency stationary ICE, you must operate the emergency stationary ICE according to the requirements in paragraphs (d)(1) through (3) of this section. In order for the engine to be considered an emergency stationary ICE under this subpart, any operation other than emergency operation, maintenance and testing, emergency demand response, and operation in non-emergency situations for 50 hours per year, as described in paragraphs (d)(1) through (3) of this section, is prohibited. If you do not operate the engine according to the requirements in paragraphs (d)(1) through (3) of this section, the engine will not be considered an emergency engine under this subpart and must meet all requirements for non-emergency engines.

(1) There is no time limit on the use of emergency stationary ICE in emergency situations.

(2) You may operate your emergency stationary ICE for any combination of the purposes specified in paragraphs (d)(2)(i) through (iii) of this section for a maximum of 100 hours per calendar year. Any operation for non-emergency situations as allowed by paragraph (d)(3) of this section counts as part of the 100 hours per calendar year allowed by this paragraph (d)(2).

(i) Emergency stationary ICE may be operated for maintenance checks and readiness testing, provided that the tests are recommended by federal, state or local government, the manufacturer, the vendor, the regional transmission organization or equivalent balancing authority and transmission operator, or the insurance company associated with the engine. The owner or operator may petition the Administrator for approval of additional hours to be used for maintenance checks and readiness testing, but a petition is not required if the owner or operator maintains records indicating that federal, state, or local standards require maintenance and testing of emergency ICE beyond 100 hours per calendar year.

**SECTION E. Source Group Restrictions.**

(ii)-(iii) [VACATED BY COURT ORDER]

(3) [NA – NOT USED TO SUPPLY POWER AS PART OF A FINANCIAL ARRANGEMENT]

(e) Owners and operators of stationary SI natural gas fired engines may operate their engines using propane for a maximum of 100 hours per year as an alternative fuel solely during emergency operations, but must keep records of such use. If propane is used for more than 100 hours per year in an engine that is not certified to the emission standards when using propane, the owners and operators are required to conduct a performance test to demonstrate compliance with the emission standards of § 60.4233.

(f) If you are an owner or operator of a stationary SI internal combustion engine that is less than or equal to 500 HP and you purchase a non-certified engine or you do not operate and maintain your certified stationary SI internal combustion engine and control device according to the manufacturer's written emission-related instructions, you are required to perform initial performance testing as indicated in this section, but you are not required to conduct subsequent performance testing unless the stationary engine undergoes rebuild, major repair or maintenance. Engine rebuilding means to overhaul an engine or to otherwise perform extensive service on the engine (or on a portion of the engine or engine system). For the purpose of this paragraph (f), perform extensive service means to disassemble the engine (or portion of the engine or engine system), inspect and/or replace many of the parts, and reassemble the engine (or portion of the engine or engine system) in such a manner that significantly increases the service life of the resultant engine.

(g) [NA - CATALYSTS NOT USED]

(h) [NA- UNIT(S) <500 HP]

(i) [NA - UNIT(S) NOT MODIFIED OR RECONSTRUCTED]

[73 FR 3591, Jan. 18, 2008, as amended at 76 FR 37974, June 28, 2011; 78 FR 6697, Jan. 30, 2013; 86 FR 34362, June 29, 2021]

Testing Requirements for Owners and Operators

§ 60.4244 What test methods and other procedures must I use if I am an owner or operator of a stationary SI internal combustion engine?

[NA – TESTING NOT REQUIRED FOR CERTIFIED UNITS WHICH ARE NOT ALTERED PER 60.4243(f)]

Notification, Reports, and Records for Owners and Operators

§ 60.4245 What are my notification, reporting, and recordkeeping requirements if I am an owner or operator of a stationary SI internal combustion engine?

Owners or operators of stationary SI ICE must meet the following notification, reporting and recordkeeping requirements.

(a) Owners and operators of all stationary SI ICE must keep records of the information in paragraphs (a)(1) through (4) of this section.

(1) All notifications submitted to comply with this subpart and all documentation supporting any notification.

(2) Maintenance conducted on the engine.

(3) If the stationary SI internal combustion engine is a certified engine, documentation from the manufacturer that the engine is certified to meet the emission standards and information as required in 40 CFR parts 1048, 1054, and 1060, as applicable.

(4) If the stationary SI internal combustion engine is not a certified engine or is a certified engine operating in a non-certified manner and subject to § 60.4243(a)(2), documentation that the engine meets the emission standards.

**SECTION E. Source Group Restrictions.**

(b) For all stationary SI emergency ICE greater than or equal to 500 HP manufactured on or after July 1, 2010, that do not meet the standards applicable to non-emergency engines, the owner or operator of must keep records of the hours of operation of the engine that is recorded through the non-resettable hour meter. For all stationary SI emergency ICE greater than or equal to 130 HP and less than 500 HP manufactured on or after July 1, 2011 that do not meet the standards applicable to non-emergency engines, the owner or operator of must keep records of the hours of operation of the engine that is recorded through the non-resettable hour meter. For all stationary SI emergency ICE greater than 25 HP and less than 130 HP manufactured on or after July 1, 2008, that do not meet the standards applicable to non-emergency engines, the owner or operator of must keep records of the hours of operation of the engine that is recorded through the non-resettable hour meter. The owner or operator must document how many hours are spent for emergency operation, including what classified the operation as emergency and how many hours are spent for non-emergency operation.

(c) [NA - UNIT(S) <500 HP]

(d) [NA – TESTING NOT REQUIRED FOR CERTIFIED UNITS WHICH ARE NOT ALTERED PER 60.4243(f)]

(e) [NA – NOT OPERATED FOR DEMAND RESPONSE OR VOLTAGE DEVIATION, OR TO SUPPLY POWER AS PART OF A FINANCIAL ARRANGEMENT]

[73 FR 3591, Jan. 18, 2008, as amended at 73 FR 59177, Oct. 8, 2008; 78 FR 6697, Jan. 30, 2013; 81 FR 59809, Aug. 30, 2016; 86 FR 34362, June 29, 2021]

General Provisions

§ 60.4246 What parts of the General Provisions apply to me?

Table 3 to this subpart shows which parts of the General Provisions in §§ 60.1 through 60.19 apply to you.

Regulatory Changes

Individual sources within this source group that are subject to 40 CFR Part 60 Subpart JJJJ shall comply with all applicable requirements of the Subpart. 40 CFR Part 60.4 requires submission of copies of all requests, reports and other communications to both the Department and the EPA. The EPA copies shall be forwarded to:

Associate Director
 United States Environmental Protection Agency
 Region III, Enforcement & Compliance Assurance Division
 Air, RCRA and Toxics Branch (3ED21)
 Four Penn Center
 1600 John F. Kennedy Boulevard
 Philadelphia, Pennsylvania 19103-2852

Unless otherwise approved by DEP, the DEP copies shall be reported through the Department's Greenport PUP system available through: <https://greenport.pa.gov/ePermitPublicAccess/PublicSubmission/Home>

In the event that the Federal Subpart that is the subject of this Source Group is revised, the permittee shall comply with the revised version of the subpart, and shall not be required to comply with any provisions in this permit designated as having the subpart as their authority, to the extent that such permit provisions would be inconsistent with the applicable provisions of the revised subpart.

***** Permit Shield in Effect. *****

**SECTION E. Source Group Restrictions.**

Group Name: SG16 SUBPART IIII
 Group Description: Post-2006 Emergency CI RICE

Sources included in this group

ID	Name
601C	EMERGENCY CI ENGINES POST-2006

I. RESTRICTIONS.

No additional requirements exist except as provided in other sections of this permit including Section B (Title V General Requirements).

II. TESTING REQUIREMENTS.

No additional testing requirements exist except as provided in other sections of this permit including Section B (Title V General Requirements).

III. MONITORING REQUIREMENTS.

No additional monitoring requirements exist except as provided in other sections of this permit including Section B (Title V General Requirements).

IV. RECORDKEEPING REQUIREMENTS.

No additional record keeping requirements exist except as provided in other sections of this permit including Section B (Title V General Requirements).

V. REPORTING REQUIREMENTS.

No additional reporting requirements exist except as provided in other sections of this permit including Section B (Title V General Requirements).

VI. WORK PRACTICE REQUIREMENTS.

No additional work practice requirements exist except as provided in other sections of this permit including Section B (Title V General Requirements).

VII. ADDITIONAL REQUIREMENTS.

**# 001 [40 CFR Part 60 Standards of Performance for New Stationary Sources §40 CFR 60.4200]
 Subpart IIII - Standards of Performance for Stationary Compression Ignition Internal Combustion Engines
 Am I subject to this subpart?**

§60.4200 Am I subject to this subpart?

(a) The provisions of this subpart are applicable to manufacturers, owners, and operators of stationary compression ignition (CI) internal combustion engines (ICE) and other persons as specified in paragraphs (a)(1) through (4) of this section. For the purposes of this subpart, the date that construction commences is the date the engine is ordered by the owner or operator.

(1) [NA – NOT AN ENGINE MANUFACTURER]

(2) Owners and operators of stationary CI ICE that commence construction after July 11, 2005, where the stationary CI ICE are:

(i) Manufactured after April 1, 2006, and are not fire pump engines, or

(ii) [NA – NOT FIRE PUMP ENGINES]

(3) [NA – NOT MODIFIED/RECONSTRUCTED].

**SECTION E. Source Group Restrictions.**

(4) The provisions of §60.4208 of this subpart are applicable to all owners and operators of stationary CI ICE that commence construction after July 11, 2005.

(b) [NA - NOT STATIONARY CI ICE TEST CELL/STAND]

(c) If you are an owner or operator of an area source subject to this subpart, you are exempt from the obligation to obtain a permit under 40 CFR part 70 or 40 CFR part 71, provided you are not required to obtain a permit under 40 CFR 70.3(a) or 40 CFR 71.3(a) for a reason other than your status as an area source under this subpart. Notwithstanding the previous sentence, you must continue to comply with the provisions of this subpart applicable to area sources.

(d) Stationary CI ICE may be eligible for exemption from the requirements of this subpart as described in 40 CFR part 1068, subpart C, except that owners and operators, as well as manufacturers, may be eligible to request an exemption for national security.

(e) [NA – NOT TEMPORARY REPLACEMENT UNITS]

[71 FR 39172, July 11, 2006, as amended at 76 FR 37967, June 28, 2011; 86 FR 34357, June 29, 2021]

EMISSION STANDARDS FOR MANUFACTURERS

§60.4201 What emission standards must I meet for non-emergency engines if I am a stationary CI internal combustion engine manufacturer? [NA – NOT AN ENGINE MANUFACTURER]

§60.4202 What emission standards must I meet for emergency engines if I am a stationary CI internal combustion engine manufacturer? [NA – NOT AN ENGINE MANUFACTURER]

§60.4203 How long must my engines meet the emission standards if I am a manufacturer of stationary CI internal combustion engines? [NA – NOT AN ENGINE MANUFACTURER]

EMISSION STANDARDS FOR OWNERS AND OPERATORS

§ 60.4204 What emission standards must I meet for non-emergency engines if I am an owner or operator of a stationary CI internal combustion engine? [NA – UNITS ARE EMERGENCY]

§ 60.4205 What emission standards must I meet for emergency engines if I am an owner or operator of a stationary CI internal combustion engine?

(a) [NA – UNIT(S) ARE 2007 MODEL YEAR OR LATER]

(b) - Owners and operators of 2007 model year and later emergency stationary CI ICE with a displacement of less than 30 liters per cylinder that are not fire pump engines must comply with the emission standards for new nonroad CI engines in §60.4202, for all pollutants, for the same model year and maximum engine power for their 2007 model year and later emergency stationary CI ICE.

EXCERPT FROM 60.4202

(a) Stationary CI internal combustion engine manufacturers must certify their 2007 model year and later emergency stationary CI ICE with a maximum engine power less than or equal to 2,237 KW (3,000 HP) and a displacement of less than 10 liters per cylinder that are not fire pump engines to the emission standards specified in paragraphs (a)(1) through (2) of this section.

(1) [NA – UNIT(S) >37 KW]

(2) For engines with a maximum engine power greater than or equal to 37 KW (50 HP), the certification emission standards for new nonroad CI engines for the same model year and maximum engine power in 40 CFR 89.112 and 40 CFR 89.113 for all pollutants beginning in model year 2007.

END OF EXCERPT FROM 60.4202

**SECTION E. Source Group Restrictions.**

(c) thru (f) - N/A (ENGINES DO NOT MEET THE SIZE, DISPLACEMENT, OR TYPE OF ENGINE AS SPECIFIED)

[71 FR 39172, July 11, 2006, as amended at 76 FR 37969, June 28, 2011; 86 FR 34358, June 29, 2021]

§60.4206 How long must I meet the emission standards if I am an owner or operator of a stationary CI internal combustion engine?

Owners and operators of stationary CI ICE must operate and maintain stationary CI ICE that achieve the emission standards as required in §§60.4204 and 60.4205 over the entire life of the engine.

[76 FR 37969, June 28, 2011]

FUEL REQUIREMENTS FOR OWNERS AND OPERATORS

§60.4207 What fuel requirements must I meet if I am an owner or operator of a stationary CI internal combustion engine subject to this subpart?

(a) [Reserved]

(b) Beginning October 1, 2010, owners and operators of stationary CI ICE subject to this subpart with a displacement of less than 30 liters per cylinder that use diesel fuel must use diesel fuel that meets the requirements of 40 CFR 1090.305 for nonroad diesel fuel, except that any existing diesel fuel purchased (or otherwise obtained) prior to October 1, 2010, may be used until depleted.

(c) [Reserved]

(d) Beginning June 1, 2012, owners and operators of stationary CI ICE subject to this subpart with a displacement of greater than or equal to 30 liters per cylinder must use diesel fuel that meets a maximum per-gallon sulfur content of 1,000 parts per million (ppm).

(e) [NA – NO NATIONAL SECURITY EXEMPTION]

[71 FR 39172, July 11, 2006, as amended at 76 FR 37969, June 28, 2011; 78 FR 6695, Jan. 30, 2013; 85 FR 78463, Dec. 4, 2020]

OTHER REQUIREMENTS FOR OWNERS AND OPERATORS

§60.4208 What is the deadline for importing or installing stationary CI ICE produced in previous model years?

(a) After December 31, 2008, owners and operators may not install stationary CI ICE (excluding fire pump engines) that do not meet the applicable requirements for 2007 model year engines.

(b) – (g) [NA – SPECIFIED DETAILS DO NOT APPLY]

(h) In addition to the requirements specified in §§60.4201, 60.4202, 60.4204, and 60.4205, it is prohibited to import stationary CI ICE with a displacement of less than 30 liters per cylinder that do not meet the applicable requirements specified in paragraphs (a) through (g) of this section after the dates specified in paragraphs (a) through (g) of this section.

(i) The requirements of this section do not apply to owners or operators of stationary CI ICE that have been modified, reconstructed, and do not apply to engines that were removed from one existing location and reinstalled at a new location.

[71 FR 39172, July 11, 2006, as amended at 76 FR 37969, June 28, 2011]

§60.4209 What are the monitoring requirements if I am an owner or operator of a stationary CI internal combustion engine?

If you are an owner or operator, you must meet the monitoring requirements of this section. In addition, you must also meet

**SECTION E. Source Group Restrictions.**

the monitoring requirements specified in §60.4211.

(a) If you are an owner or operator of an emergency stationary CI internal combustion engine that does not meet the standards applicable to non-emergency engines, you must install a non-resettable hour meter prior to startup of the engine.

(b) [NA – NO DIESEL PARTICULATE FILTERS].

[71 FR 39172, July 11, 2006, as amended at 76 FR 37969, June 28, 2011]

COMPLIANCE REQUIREMENTS

§60.4210 What are my compliance requirements if I am a stationary CI internal combustion engine manufacturer? [NA – NOT AN ENGINE MANUFACTURER]

§60.4211 What are my compliance requirements if I am an owner or operator of a stationary CI internal combustion engine?

(a) If you are an owner or operator and must comply with the emission standards specified in this subpart, you must do all of the following, except as permitted under paragraph (g) of this section:

(1) Operate and maintain the stationary CI internal combustion engine and control device according to the manufacturer's emission-related written instructions;

(2) Change only those emission-related settings that are permitted by the manufacturer; and

(3) Meet the requirements of 40 CFR part 1068, as they apply to you.

(b) [NA – UNIT(S) NOT PRE-2007].

(c) If you are an owner or operator of a 2007 model year and later stationary CI internal combustion engine and must comply with the emission standards specified in §60.4204(b) or §60.4205(b), or if you are an owner or operator of a CI fire pump engine that is manufactured during or after the model year that applies to your fire pump engine power rating in table 3 to this subpart and must comply with the emission standards specified in §60.4205(c), you must comply by purchasing an engine certified to the emission standards in §60.4204(b), or §60.4205(b) or (c), as applicable, for the same model year and maximum (or in the case of fire pumps, NFPA nameplate) engine power. The engine must be installed and configured according to the manufacturer's emission-related specifications, except as permitted in paragraph (g) of this section.

(d) [NA – SPECIFIED SECTIONS DO NOT APPLY]

(e) [NA – UNIT(S) NOT MODIFIED OR RECONSTRUCTED AFTER 7/11/05]

(f) If you own or operate an emergency stationary ICE, you must operate the emergency stationary ICE according to the requirements in paragraphs (f)(1) through (3) of this section. In order for the engine to be considered an emergency stationary ICE under this subpart, any operation other than emergency operation, maintenance and testing, emergency demand response, and operation in non-emergency situations for 50 hours per year, as described in paragraphs (f)(1) through (3) of this section, is prohibited. If you do not operate the engine according to the requirements in paragraphs (f)(1) through (3) of this section, the engine will not be considered an emergency engine under this subpart and must meet all requirements for non-emergency engines.

(1) There is no time limit on the use of emergency stationary ICE in emergency situations.

(2) You may operate your emergency stationary ICE for any combination of the purposes specified in paragraphs (f)(2)(i) through (iii) of this section for a maximum of 100 hours per calendar year. Any operation for non-emergency situations as allowed by paragraph (f)(3) of this section counts as part of the 100 hours per calendar year allowed by this paragraph (f)(2).

(i) Emergency stationary ICE may be operated for maintenance checks and readiness testing, provided that the tests are recommended by federal, state or local government, the manufacturer, the vendor, the regional transmission organization

**SECTION E. Source Group Restrictions.**

or equivalent balancing authority and transmission operator, or the insurance company associated with the engine. The owner or operator may petition the Administrator for approval of additional hours to be used for maintenance checks and readiness testing, but a petition is not required if the owner or operator maintains records indicating that federal, state, or local standards require maintenance and testing of emergency ICE beyond 100 hours per calendar year.

(ii) – (iii) [VACATED PER COURT ORDER AS OF 5/2/16]

(3) Emergency stationary ICE may be operated for up to 50 hours per calendar year in non-emergency situations. The 50 hours of operation in non-emergency situations are counted as part of the 100 hours per calendar year for maintenance and testing and emergency demand response provided in paragraph (f)(2) of this section. Except as provided in paragraph (f)(3)(i) of this section, the 50 hours per calendar year for non-emergency situations cannot be used for peak shaving or non-emergency demand response, or to generate income for a facility to an electric grid or otherwise supply power as part of a financial arrangement with another entity.

(i) The 50 hours per year for non-emergency situations can be used to supply power as part of a financial arrangement with another entity if all of the following conditions are met:

(A) The engine is dispatched by the local balancing authority or local transmission and distribution system operator;

(B) The dispatch is intended to mitigate local transmission and/or distribution limitations so as to avert potential voltage collapse or line overloads that could lead to the interruption of power supply in a local area or region.

(C) The dispatch follows reliability, emergency operation or similar protocols that follow specific NERC, regional, state, public utility commission or local standards or guidelines.

(D) The power is provided only to the facility itself or to support the local transmission and distribution system.

(E) The owner or operator identifies and records the entity that dispatches the engine and the specific NERC, regional, state, public utility commission or local standards or guidelines that are being followed for dispatching the engine. The local balancing authority or local transmission and distribution system operator may keep these records on behalf of the engine owner or operator.

(ii) [Reserved]

(g) If you do not install, configure, operate, and maintain your engine and control device according to the manufacturer's emission-related written instructions, or you change emission-related settings in a way that is not permitted by the manufacturer, you must demonstrate compliance as follows:

(1) [NA – UNIT(S) = 100 HP]

(2) If you are an owner or operator of a stationary CI internal combustion engine greater than or equal to 100 HP and less than or equal to 500 HP, you must keep a maintenance plan and records of conducted maintenance and must, to the extent practicable, maintain and operate the engine in a manner consistent with good air pollution control practice for minimizing emissions. In addition, you must conduct an initial performance test to demonstrate compliance with the applicable emission standards within 1 year of startup, or within 1 year after an engine and control device is no longer installed, configured, operated, and maintained in accordance with the manufacturer's emission-related written instructions, or within 1 year after you change emission-related settings in a way that is not permitted by the manufacturer.

(3) [NA – UNIT(S) < 500 HP].

(h) The requirements for operators and prohibited acts specified in 40 CFR 1039.665 apply to owners or operators of stationary CI ICE equipped with AECDs for qualified emergency situations as allowed by 40 CFR 1039.665.

[71 FR 39172, July 11, 2006, as amended at 76 FR 37970, June 28, 2011; 78 FR 6695, Jan. 30, 2013; 81 FR 44219, July 7, 2016; 86 FR 34359, June 29, 2021]

TESTING REQUIREMENTS FOR OWNERS AND OPERATORS

**SECTION E. Source Group Restrictions.**

§60.4212 What test methods and other procedures must I use if I am an owner or operator of a stationary CI internal combustion engine with a displacement of less than 30 liters per cylinder? [NA – TESTING NOT REQUIRED FOR CERTIFIED UNITS WHICH ARE NOT ALTERED PER 60.4211(g)]

§60.4213 What test methods and other procedures must I use if I am an owner or operator of a stationary CI internal combustion engine with a displacement of greater than or equal to 30 liters per cylinder? [NA – DISPLACEMENT < 30 L/CYL]

NOTIFICATION, REPORTS, AND RECORDS FOR OWNERS AND OPERATORS

§60.4214 What are my notification, reporting, and recordkeeping requirements if I am an owner or operator of a stationary CI internal combustion engine?

(a) [NA – UNIT(S) ARE EMERGENCY]

(b) If the stationary CI internal combustion engine is an emergency stationary internal combustion engine, the owner or operator is not required to submit an initial notification. Starting with the model years in table 5 to this subpart, if the emergency engine does not meet the standards applicable to non-emergency engines in the applicable model year, the owner or operator must keep records of the operation of the engine in emergency and non-emergency service that are recorded through the non-resettable hour meter. The owner must record the time of operation of the engine and the reason the engine was in operation during that time.

(c) [NA – NO DIESEL PARTICULATE FILTER(S)]

(d) [NA - ENGINES ARE NOT USED OR OBLIGATED FOR THE PURPOSES SPECIFIED IN 60.4211(f)(2)(ii) OR (iii) OR §60.4211(f)(3)(i)]

(e) Owners or operators of stationary CI ICE equipped with AECDs pursuant to the requirements of 40 CFR 1039.665 must report the use of AECDs as required by 40 CFR 1039.665(e).

[71 FR 39172, July 11, 2006, as amended at 78 FR 6696, Jan. 30, 2013; 81 FR 44219, July 7, 2016]

SPECIAL REQUIREMENTS

§60.4215 What requirements must I meet for engines used in Guam, American Samoa, or the Commonwealth of the Northern Mariana Islands? [NA – ENGINE(S) DO NOT MEET SPECIFIED GEOGRAPHY]

§60.4216 What requirements must I meet for engines used in Alaska? [NA – ENGINE(S) DO NOT MEET SPECIFIED GEOGRAPHY]

§60.4217 What emission standards must I meet if I am an owner or operator of a stationary internal combustion engine using special fuels? [NA – ENGINE(S) DO NOT USE SPECIAL FUELS]

GENERAL PROVISIONS

§60.4218 What parts of the General Provisions apply to me?

Table 8 to this subpart shows which parts of the General Provisions in §§60.1 through 60.19 apply to you. [TABLE 8 INCORPORATED BY REFERENCE]

DEFINITIONS [INCORPORATED BY REFERENCE]

REGULATORY CHANGES

Individual sources within this source group that are subject to 40 CFR Part 60 Subpart IIII shall comply with all applicable requirements of the Subpart. 40 CFR 60.4 requires submission of copies of all requests, reports and other communications to the Department and/or the EPA, as may be required. The EPA copies shall be forwarded to:

**SECTION E. Source Group Restrictions.**

Associate Director
United States Environmental Protection Agency
Region III, Enforcement & Compliance Assurance Division
Air, RCRA and Toxics Branch (3ED21)
Four Penn Center
1600 John F. Kennedy Boulevard
Philadelphia, Pennsylvania 19103-2852

Unless otherwise approved by DEP, the DEP copies shall be reported through the Department's Greenport PUP system available through: <https://greenport.pa.gov/ePermitPublicAccess/PublicSubmission/Home>

In the event that the Federal Subpart that is the subject of this Source Group is revised, the permittee shall comply with the revised version of the subpart, and shall not be required to comply with any provisions in this permit designated as having the subpart as their authority, to the extent that such permit provisions would be inconsistent with the applicable provisions of the revised subpart.

***** Permit Shield in Effect. *****

**SECTION E. Source Group Restrictions.**

Group Name: SG17 MIST ELIMINATOR CAM

Group Description: CAM for Mist Eliminatrors

Sources included in this group

ID	Name
139	A-2 BATTERY FORMATION (8 MIST ELIMN)
149	IND FORMING ROOM & WET CHARGE (4 MIST ELIM)
150	IND BATTERY BOOST (4 MIST ELIM)
186	S-1 BATTERY ACTTN/BOOSTIN (5 MIST ELIM)
187	S- 1 BATT FORMATION (10 MIST ELIM)
191	A-3- BATTERY FORMATION (9 MIST ELIM)
302	S-1A FORMATION ANNEX (3 MIST ELIM)
406	A-4 BATTERY FORMATION (9) (MIST ELIM)
718	IND BATT FORMATION FOR A-3 (6 MIST ELIM)
727	IND AUTO BAT W/BATH FORM (2 MIST ELIMN)

I. RESTRICTIONS.

No additional requirements exist except as provided in other sections of this permit including Section B (Title V General Requirements).

II. TESTING REQUIREMENTS.

No additional testing requirements exist except as provided in other sections of this permit including Section B (Title V General Requirements).

III. MONITORING REQUIREMENTS.

No additional monitoring requirements exist except as provided in other sections of this permit including Section B (Title V General Requirements).

IV. RECORDKEEPING REQUIREMENTS.

No additional record keeping requirements exist except as provided in other sections of this permit including Section B (Title V General Requirements).

V. REPORTING REQUIREMENTS.

No additional reporting requirements exist except as provided in other sections of this permit including Section B (Title V General Requirements).

VI. WORK PRACTICE REQUIREMENTS.

No additional work practice requirements exist except as provided in other sections of this permit including Section B (Title V General Requirements).

VII. ADDITIONAL REQUIREMENTS.**# 001 [40 CFR Part 64 Compliance Assurance Monitoring for Major Stationary Sources §40 CFR 64.3]****Sections of PART 64****Monitoring design criteria**

[Additional authority for this Compliance Assurance Monitoring (CAM) permit condition is also derived from 40 CFR Part 64, Sections 64.1-64.10]

The following conditions apply to mist eliminators controlling emissions from sources in this source group:

#AAA

(a) The permittee shall use the pressure differential across each mist eliminator to obtain data and monitor the equipment

**SECTION E. Source Group Restrictions.**

performance.

(b) The permittee shall operate and maintain magnehelic gauges (or equivalent devices) across each mist eliminator to measure the pressure differential described in (a), above.

(c) The permittee shall monitor the process parameters described in (a), above, once per week for each mist eliminator.

#BBB

(a) The permittee shall maintain records of the following information related to CAM:

(1) All monitor readings and excursions.

(2) all excursions and corrective actions taken in response to an excursion and the time elapsed until the corrective actions have been taken.

(3) all inspections, repairs and maintenance performed on the process parameter monitoring equipment.

(4) all monitoring equipment down time incidents (other than down time associated with accuracy checks or calibration checks). The permittee shall also record the dates, times and durations, possible causes and corrective actions taken for the incidents.

(5) The number of hours of operation of each source during each six-month reporting period.

(b) The permittee shall keep all records for a period of five (5) years and make the records available to the Department upon request.

#CCC

(a) The permittee shall report all excursions and corrective actions taken, the dates, times, durations and possible causes, every six (6) months.

(b) The permittee shall report all monitoring equipment down time incidents (other than down time associated with accuracy checks or calibration checks), their dates, times and durations, possible causes and corrective actions taken, every six (6) months.

#DDD

(a) The following shall be defined as an excursion:

A departure from the parameter ranges specified in the Section C CAM Range Condition, based on each weekly parameter value shall be defined as an excursion. Failure to perform weekly monitoring/record keeping of any process parameter for less than 90% of the required readings in a reporting period shall also be defined as an excursion.

(b) The permittee shall maintain spare monitoring equipment and related parts on site for routine repairs/replacement.

#EEE

(a) The permittee shall develop and implement a quality improvement plan (QIP) as expeditiously as practicable if any of the following occurs:

(1) Six excursions of any given parameter range occur in a six-month reporting period for an individual mist eliminator.

(2) Failure to perform weekly monitoring of any given parameter, for any given mist eliminator, for less than 90% of the required readings in a reporting period.

(3) The Department determines after review of all reported information that the permittee has not responded acceptably to an excursion.

(b) The QIP should be developed within 60 days of the end of the relevant six-month reporting period, and the permittee shall provide a copy of the QIP to the Department. Furthermore, the permittee shall notify the Department if the period for completing the improvements contained in the QIP exceeds 180 days from the date on which the need to implement the QIP was determined.

**SECTION E. Source Group Restrictions.**

(c) The permittee shall record actions taken to implement the QIP during a reporting period and all related actions including, but not limited to inspections, repairs and maintenance performed on the monitoring equipment.

(d) The QIP shall include procedures for evaluating any control device performance problems on such devices associated with the QIP. Based on the results of the evaluation procedures, the permittee shall modify the QIP, and provide a copy to the Department, to include procedures for conducting more frequent or improved monitoring in conjunction with one or more of the following:

- (1) Improved preventive maintenance practices.
- (2) Process operation changes.
- (3) Appropriate improvements to control methods.
- (4) Other steps appropriate to correct performance.

(e) Following implementation of a QIP, the Department will require reasonable revisions to the QIP if the plan has failed to either:

- (1) Address the cause of the control device performance problem.
- (2) Provide adequate procedures for correcting control device performance problems as expeditiously as practicable in accordance with good air pollution control practices for minimizing emissions.

(f) Implementation of a QIP shall not excuse the owner or operator of a source from compliance with any existing emission limitation or standard or any existing monitoring, testing, reporting or recordkeeping requirement that may apply under any federal, state, or local laws or any other applicable requirements under the Clean Air Act.

***** Permit Shield in Effect. *****

**SECTION E. Source Group Restrictions.**

Group Name: SG18 SUBPART MMMM

Group Description: 40 CFR 63 Subpart MMMM

Sources included in this group

ID	Name
603	SMALL PARTS COATING OPERATION
604	IND BATTERY TOUCH-UP OPERATION
604B	IND BATTERY TOUCH-UP OPERATION (POST-2012)

I. RESTRICTIONS.

No additional requirements exist except as provided in other sections of this permit including Section B (Title V General Requirements).

II. TESTING REQUIREMENTS.

No additional testing requirements exist except as provided in other sections of this permit including Section B (Title V General Requirements).

III. MONITORING REQUIREMENTS.

No additional monitoring requirements exist except as provided in other sections of this permit including Section B (Title V General Requirements).

IV. RECORDKEEPING REQUIREMENTS.

No additional record keeping requirements exist except as provided in other sections of this permit including Section B (Title V General Requirements).

V. REPORTING REQUIREMENTS.

No additional reporting requirements exist except as provided in other sections of this permit including Section B (Title V General Requirements).

VI. WORK PRACTICE REQUIREMENTS.

No additional work practice requirements exist except as provided in other sections of this permit including Section B (Title V General Requirements).

VII. ADDITIONAL REQUIREMENTS.**# 001 [40 CFR Part 63 NESHAPS for Source Categories §40 CFR 63.3880]****Subpart MMMM - National Emission Standards for Hazardous Air Pollutants for Surface Coating of Miscellaneous Metal Parts and Products****What is the purpose of this subpart?**

§63.3880 What is the purpose of this subpart?

This subpart establishes national emission standards for hazardous air pollutants (NESHAP) for miscellaneous metal parts and products surface coating facilities. This subpart also establishes requirements to demonstrate initial and continuous compliance with the emission limitations.

§63.3881 Am I subject to this subpart?

(a) Miscellaneous metal parts and products include, but are not limited to, metal components of the following types of products as well as the products themselves: motor vehicle parts and accessories, bicycles and sporting goods, recreational vehicles, extruded aluminum structural components, railroad cars, heavy duty trucks, medical equipment, lawn and garden equipment, electronic equipment, magnet wire, steel drums, industrial machinery, metal pipes, and numerous other industrial, household, and consumer products. Except as provided in paragraph (c) of this section, the source category to which this subpart applies is the surface coating of any miscellaneous metal parts or products, as described in paragraph (a)(1) of this section, and it includes the subcategories listed in paragraphs (a)(2) through (6) of this section.

**SECTION E. Source Group Restrictions.**

(1) Surface coating is the application of coating to a substrate using, for example, spray guns or dip tanks. When application of coating to a substrate occurs, then surface coating also includes associated activities, such as surface preparation, cleaning, mixing, and storage. However, these activities do not comprise surface coating if they are not directly related to the application of the coating. Coating application with handheld, non-refillable aerosol containers, touch-up markers, marking pens, or the application of paper film or plastic film which may be pre-coated with an adhesive by the manufacturer are not coating operations for the purposes of this subpart.

(2) The general use coating subcategory includes all surface coating operations that are not high performance, magnet wire, rubber-to-metal, or extreme performance fluoropolymer coating operations.

(3) - (6) [N/A-- GENERAL USE COATING USED]

(b) You are subject to this subpart if you own or operate a new, reconstructed, or existing affected source, as defined in §63.3882, that uses 946 liters (250 gallons (gal)) per year, or more, of coatings that contain hazardous air pollutants (HAP) in the surface coating of miscellaneous metal parts and products defined in paragraph (a) of this section; and that is a major source, is located at a major source, or is part of a major source of emissions of HAP. A major source of HAP emissions is any stationary source or group of stationary sources located within a contiguous area and under common control that emits or has the potential to emit any single HAP at a rate of 9.07 megagrams (Mg) (10 tons) or more per year or any combination of HAP at a rate of 22.68 Mg (25 tons) or more per year. You do not need to include coatings that meet the definition of non-HAP coating contained in §63.3981 in determining whether you use 946 liters (250 gal) per year, or more, of coatings in the surface coating of miscellaneous metal parts and products.

(c) This subpart does not apply to surface coating or a coating operation that meets any of the criteria of paragraphs (c)(1) through (17) of this section. [NA - NONE OF THE LISTED EXEMPTIONS APPLY]

(d) [N/A – SURFACE COATING NOT OF METAL COMPONENTS OF AUTOMOBILES OR LIGHT DUTY TRUCKS]

(e) [N/A – FACILITY DOES NOT MEET APPLICABILITY CRITERIA OF ANOTHER SURFACE COATING NESHAP]

[69 FR 157, Jan. 2, 2004, as amended at 69 FR 22660, Apr. 26, 2004; 71 FR 76927, Dec. 22, 2006]

§63.3882 What parts of my plant does this subpart cover?

(a) This subpart applies to each new, reconstructed, and existing affected source within each of the four subcategories listed in §63.3881(a).

(b) The affected source is the collection of all of the items listed in paragraphs (b)(1) through (4) of this section that are used for surface coating of miscellaneous metal parts and products within each subcategory.

(1) All coating operations as defined in §63.3981;

(2) All storage containers and mixing vessels in which coatings, thinners and/or other additives, and cleaning materials are stored or mixed;

(3) All manual and automated equipment and containers used for conveying coatings, thinners and/or other additives, and cleaning materials; and

(4) All storage containers and all manual and automated equipment and containers used for conveying waste materials generated by a coating operation.

(c) [NA - SOURCE IS EXISTING]

(d) [NA - SOURCE IS EXISTING]

(e) An affected source is existing if it is not new or reconstructed.

§63.3883 When do I have to comply with this subpart?

**SECTION E. Source Group Restrictions.**

The date by which you must comply with this subpart is called the compliance date. The compliance date for each type of affected source is specified in paragraphs (a) through (c) of this section. The compliance date begins the initial compliance period during which you conduct the initial compliance demonstration described in §§63.3940, 63.3950, and 63.3960.

(a) [NA - SOURCE IS EXISTING]

(b) For an existing affected source, the compliance date is the date 3 years after January 2, 2004.

(c) [NA - SOURCE WAS MAJOR PRIOR TO RULE EFFECTIVE DATE]

(d) You must meet the notification requirements in §63.3910 according to the dates specified in that section and in subpart A of this part. Some of the notifications must be submitted before the compliance dates described in paragraphs (a) through (c) of this section.

EMISSION LIMITATIONS

§63.3890 What emission limits must I meet?

(a) [NA - SOURCE IS EXISTING]

(b) For an existing affected source, you must limit organic HAP emissions to the atmosphere from the affected source to the applicable limit specified in paragraphs (b)(1) through (5) of this section, except as specified in paragraph (c) of this section, determined according to the requirements in §63.3941, §63.3951, or §63.3961.

(1) For each existing general use coating affected source, limit organic HAP emissions to no more than 0.31 kg (2.6 lb) organic HAP per liter (gal) coating solids used during each 12-month compliance period.

(2) - (5) [N/A – GENERAL USE COATING USED]

(c) [N/A – ONLY GENERAL USE COATING USED]

§63.3891 What are my options for meeting the emission limits?

You must include all coatings (as defined in §63.3981), thinners and/or other additives, and cleaning materials used in the affected source when determining whether the organic HAP emission rate is equal to or less than the applicable emission limit in §63.3890. To make this determination, you must use at least one of the three compliance options listed in paragraphs (a) through (c) of this section. You may apply any of the compliance options to an individual coating operation, or to multiple coating operations as a group, or to the entire affected source. You may use different compliance options for different coating operations, or at different times on the same coating operation. You may employ different compliance options when different coatings are applied to the same part, or when the same coating is applied to different parts. However, you may not use different compliance options at the same time on the same coating operation. If you switch between compliance options for any coating operation or group of coating operations, you must document this switch as required by §63.3930(c), and you must report it in the next semiannual compliance report required in §63.3920.

(a) [NA - EMISSION RATE WITHOUT ADD-ON CONTROL OPTION USED]

(b) Emission rate without add-on controls option. Demonstrate that, based on the coatings, thinners and/or other additives, and cleaning materials used in the coating operation(s), the organic HAP emission rate for the coating operation(s) is less than or equal to the applicable emission limit in §63.3890, calculated as a rolling 12-month emission rate and determined on a monthly basis. You must meet all the requirements of §§63.3950, 63.3951, and 63.3952 to demonstrate compliance with the emission limit using this option.

(c) [NA - EMISSION RATE WITHOUT ADD-ON CONTROL OPTION USED]

§63.3892 What operating limits must I meet?

(a) For any coating operation(s) on which you use the compliant material option or the emission rate without add-on

**SECTION E. Source Group Restrictions.**

controls option, you are not required to meet any operating limits.

(b) - (c) [NA - EMISSION RATE WITHOUT ADD-ON CONTROL OPTION USED]

§63.3893 What work practice standards must I meet?

(a) For any coating operation(s) on which you use the compliant material option or the emission rate without add-on controls option, you are not required to meet any work practice standards.

(b) - (c) [NA - EMISSION RATE WITHOUT ADD-ON CONTROL OPTION USED]

GENERAL COMPLIANCE REQUIREMENTS

§63.3900 What are my general requirements for complying with this subpart?

(a) You must be in compliance with the emission limitations in this subpart as specified in paragraphs (a)(1) and (2) of this section.

(1) Any coating operation(s) for which you use the compliant material option or the emission rate without add-on controls option, as specified in §63.3891(a) and (b), must be in compliance with the applicable emission limit in §63.3890 at all times.

(2) [NA - EMISSION RATE WITHOUT ADD-ON CONTROL OPTION USED]

(b) Before January 5, 2021, you must always operate and maintain your affected source, including all air pollution control and monitoring equipment you use for purposes of complying with this subpart, according to the provisions in § 63.6(e)(1)(i). On and after January 5, 2021, at all times, the owner or operator must operate and maintain any affected source, including associated air pollution control equipment and monitoring equipment, in a manner consistent with safety and good air pollution control practices for minimizing emissions. The general duty to minimize emissions does not require the owner or operator to make any further efforts to reduce emissions if levels required by the applicable standard have been achieved. Determination of whether a source is operating in compliance with operation and maintenance requirements will be based on information available to the Administrator that may include, but is not limited to, monitoring results, review of operation and maintenance procedures, review of operation and maintenance records, and inspection of the affected source.

(c) [NA - EMISSION RATE WITHOUT ADD-ON CONTROL OPTION USED]

[69 FR 157, Jan. 2, 2004, as amended at 71 FR 20465, Apr. 20, 2006; 85 FR 41138, July 8, 2020]

§63.3901 What parts of the General Provisions apply to me?

Table 2 to this subpart shows which parts of the General Provisions in §§63.1 through 63.15 apply to you.

NOTIFICATIONS, REPORTS, AND RECORDS

§63.3910 What notifications must I submit?

(a) General. You must submit the notifications in §§63.7(b) and (c), 63.8(f)(4), and 63.9(b) through (e) and (h) that apply to you by the dates specified in those sections, except as provided in paragraphs (b) and (c) of this section.

(b) [INITIAL NOTIFICATION REQUIREMENT IS IN THE PAST]

(c) [NOCS REQUIREMENT IS IN THE PAST]

[69 FR 157, Jan. 2, 2004, as amended at 69 FR 22660, Apr. 26, 2004; 85 FR 73906, Nov. 19, 2020]

§63.3920 What reports must I submit?

**SECTION E. Source Group Restrictions.**

- (a) Semiannual compliance reports. You must submit semiannual compliance reports for each affected source according to the requirements of paragraphs (a)(1) through (7) of this section. The semiannual compliance reporting requirements may be satisfied by reports required under other parts of the Clean Air Act (CAA), as specified in paragraph (a)(2) of this section.
- (1) Dates. Unless the Administrator has approved or agreed to a different schedule for submission of reports under §63.10(a), you must prepare and submit each semiannual compliance report according to the dates specified in paragraphs (a)(1)(i) through (iv) of this section. Note that the information reported for each of the months in the reporting period will be based on the last 12 months of data prior to the date of each monthly calculation.
- (i) The first semiannual compliance report must cover the first semiannual reporting period which begins the day after the end of the initial compliance period described in §63.3940, §63.3950, or §63.3960 that applies to your affected source and ends on June 30 or December 31, whichever date is the first date following the end of the initial compliance period.
- (ii) Each subsequent semiannual compliance report must cover the subsequent semiannual reporting period from January 1 through June 30 or the semiannual reporting period from July 1 through December 31.
- (iii) Each semiannual compliance report must be postmarked or delivered no later than July 31 or January 31, whichever date is the first date following the end of the semiannual reporting period.
- (iv) For each affected source that is subject to permitting regulations pursuant to 40 CFR part 70 or 40 CFR part 71, and if the permitting authority has established dates for submitting semiannual reports pursuant to 40 CFR 70.6(a)(3)(iii)(A) or 40 CFR 71.6(a)(3)(iii)(A), you may submit the first and subsequent compliance reports according to the dates the permitting authority has established instead of according to the date specified in paragraph (a)(1)(iii) of this section.
- (2) Inclusion with title V report. Each affected source that has obtained a title V operating permit pursuant to 40 CFR part 70 or 40 CFR part 71 must report all deviations as defined in this subpart in the semiannual monitoring report required by 40 CFR 70.6(a)(3)(iii)(A) or 40 CFR 71.6(a)(3)(iii)(A). If an affected source submits a semiannual compliance report pursuant to this section along with, or as part of, the semiannual monitoring report required by 40 CFR 70.6(a)(3)(iii)(A) or 40 CFR 71.6(a)(3)(iii)(A), and the semiannual compliance report includes all required information concerning deviations from any emission limitation in this subpart, its submission will be deemed to satisfy any obligation to report the same deviations in the semiannual monitoring report. However, submission of a semiannual compliance report shall not otherwise affect any obligation the affected source may have to report deviations from permit requirements to the permitting authority.
- (3) General requirements. The semiannual compliance report must contain the information specified in paragraphs (a)(3)(i) through (vii) of this section, and the information specified in paragraphs (a)(4) through (7) and (c)(1) of this section that is applicable to your affected source.
- (i) Company name and address.
- (ii) Statement by a responsible official with that official's name, title, and signature, certifying the truth, accuracy, and completeness of the content of the report.
- (iii) Date of report and beginning and ending dates of the reporting period. The reporting period is the 6-month period ending on June 30 or December 31. Note that the information reported for each of the 6 months in the reporting period will be based on the last 12 months of data prior to the date of each monthly calculation.
- (iv) Identification of the compliance option or options specified in §63.3891 that you used on each coating operation during the reporting period. If you switched between compliance options during the reporting period, you must report the beginning and ending dates for each option you used.
- (v) If you used the emission rate without add-on controls or the emission rate with add-on controls compliance option (§63.3891(b) or (c)), the calculation results for each rolling 12-month organic HAP emission rate during the 6-month reporting period.
- (vi) If you used the predominant activity alternative (§63.3890(c)(1)), include the annual determination of predominant activity if it was not included in the previous semi-annual compliance report.

**SECTION E. Source Group Restrictions.**

(vii) If you used the facility-specific emission limit alternative (§63.3890(c)(2)), include the calculation of the facility-specific emission limit for each 12-month compliance period during the 6-month reporting period.

(4) No deviations. If there were no deviations from the emission limitations in §§63.3890, 63.3892, and 63.3893 that apply to you, the semiannual compliance report must include a statement that there were no deviations from the emission limitations during the reporting period. If you used the emission rate with add-on controls option and there were no periods during which the continuous parameter monitoring systems (CPMS) were out-of-control as specified in §63.8(c)(7), the semiannual compliance report must include a statement that there were no periods during which the CPMS were out-of-control during the reporting period.

(5) [NA - EMISSION RATE WITHOUT ADD-ON CONTROL OPTION USED]

(6) Deviations: Emission rate without add-on controls option. If you used the emission rate without add-on controls option and there was a deviation from the applicable emission limit in § 63.3890, the semiannual compliance report must contain the information in paragraphs (a)(6)(i) through (iv) of this section.

(i) The beginning and ending dates of each compliance period during which the 12-month organic HAP emission rate exceeded the applicable emission limit in §63.3890.

(ii) The calculations used to determine the 12-month organic HAP emission rate for the compliance period in which the deviation occurred. You must submit the calculations for Equations 1, 1A through 1C, 2, and 3 of §63.3951; and if applicable, the calculation used to determine mass of organic HAP in waste materials according to §63.3951(e)(4). You do not need to submit background data supporting these calculations (e.g., information provided by materials suppliers or manufacturers, or test reports).

(iii) Before January 5, 2021, a statement of the cause of each deviation. On and after January 5, 2021, a statement of the cause of each deviation (including unknown cause, if applicable).

(iv) On and after January 5, 2021, the number of deviations and, for each deviation, the date, time, duration, a list of the affected source or equipment, an estimate of the quantity of each regulated pollutant emitted over any applicable emission limit in § 63.3890, a description of the method used to estimate the emissions, and the actions you took to minimize emissions in accordance with § 63.3900(b).

(7) [NA - EMISSION RATE WITHOUT ADD-ON CONTROL OPTION USED]

(b) - (c) [NA - EMISSION RATE WITHOUT ADD-ON CONTROL OPTION USED]

(d) Performance test reports. On and after January 5, 2021, you must submit the results of the performance test required in §§ 63.3940 and 63.3950 following the procedure specified in paragraphs (d)(1) through (3) of this section.

(1) For data collected using test methods supported by the EPA's Electronic Reporting Tool (ERT) as listed on the EPA's ERT website (<https://www.epa.gov/electronic-reporting-air-emissions/electronic-reporting-tool-ert>) at the time of the test, you must submit the results of the performance test to the EPA via the Compliance and Emissions Data Reporting Interface (CEDRI). The CEDRI interface can be accessed through the EPA's Central Data Exchange (CDX) (<https://cdx.epa.gov/>). Performance test data must be submitted in a file format generated through the use of the EPA's ERT or an alternate electronic file format consistent with the extensible markup language (XML) schema listed on the EPA's ERT website.

(2) For data collected using test methods that are not supported by the EPA's ERT as listed on the EPA's ERT website at the time of the test, you must submit the results of the performance test to the Administrator at the appropriate address listed in § 63.13, unless the Administrator agrees to or specifies an alternate reporting method.

(3) If you claim that some of the performance test information being submitted under paragraph (d)(1) of this section is Confidential Business Information (CBI), you must submit a complete file generated through the use of the EPA's ERT or an alternate electronic file consistent with the XML schema listed on the EPA's ERT website, including information claimed to be CBI, on a compact disc, flash drive, or other commonly used electronic storage medium to the EPA. The electronic medium must be clearly marked as CBI and mailed to U.S. EPA/OAPQS/CORE CBI Office, Attention: Group Leader, Measurement Policy Group, MD C404-02, 4930 Old Page Rd., Durham, NC 27703. The same ERT or alternate file with the CBI omitted must be submitted to the EPA via the EPA's CDX as described in paragraph (d)(1) of this section.

**SECTION E. Source Group Restrictions.**

(e) Initial notification reports. On and after January 5, 2021, the owner or operator shall submit the initial notifications required in § 63.9(b) and the notification of compliance status required in §§ 63.9(h) and 63.3910(c) to the EPA via the CEDRI. The CEDRI interface can be accessed through the EPA's CDX (<https://cdx.epa.gov/>). The owner or operator must upload to CEDRI an electronic copy of each applicable notification in portable document format (PDF). The applicable notification must be submitted by the deadline specified in this subpart, regardless of the method in which the reports are submitted. Owners or operators who claim that some of the information required to be submitted via CEDRI is CBI shall submit a complete report generated using the appropriate form in CEDRI or an alternate electronic file consistent with the XML schema listed on the EPA's CEDRI website, including information claimed to be CBI, on a compact disc, flash drive, or other commonly used electronic storage medium to the EPA. The electronic medium shall be clearly marked as CBI and mailed to U.S. EPA/OAQPS/CORE CBI Office, Attention: Group Leader, Measurement Policy Group, MD C404-02, 4930 Old Page Rd., Durham, NC 27703. The same file with the CBI omitted shall be submitted to the EPA via the EPA's CDX as described earlier in this paragraph.

(f) Semiannual compliance reports. On and after January 5, 2021, or once the reporting template has been available on the CEDRI website for 1 year, whichever date is later, the owner or operator shall submit the semiannual compliance report required in paragraph (a) of this section to the EPA via the CEDRI. The CEDRI interface can be accessed through the EPA's CDX (<https://cdx.epa.gov/>). The owner or operator must use the appropriate electronic template on the CEDRI website for this subpart or an alternate electronic file format consistent with the XML schema listed on the CEDRI website (<https://www.epa.gov/electronic-reporting-air-emissions/compliance-and-emissions-data-reporting-interface-cedri>). The date report templates become available will be listed on the CEDRI website. If the reporting form for the semiannual compliance report specific to this subpart is not available in CEDRI at the time that the report is due, you must submit the report to the Administrator at the appropriate addresses listed in § 63.13. Once the form has been available in CEDRI for 1 year, you must begin submitting all subsequent reports via CEDRI. The reports must be submitted by the deadlines specified in this subpart, regardless of the method in which the reports are submitted. Owners or operators who claim that some of the information required to be submitted via CEDRI is CBI shall submit a complete report generated using the appropriate form in CEDRI or an alternate electronic file consistent with the XML schema listed on the EPA's CEDRI website, including information claimed to be CBI, on a compact disc, flash drive, or other commonly used electronic storage medium to the EPA. The electronic medium shall be clearly marked as CBI and mailed to U.S. EPA/OAQPS/CORE CBI Office, Attention: Group Leader, Measurement Policy Group, MD C404-02, 4930 Old Page Rd., Durham, NC 27703. The same file with the CBI omitted shall be submitted to the EPA via the EPA's CDX as described earlier in this paragraph.

(g) Reporting during EPA system outages. If you are required to electronically submit a report through the CEDRI in the EPA's CDX, and due to a planned or actual outage of either the EPA's CEDRI or CDX systems within the period of time beginning 5 business days prior to the date that the submission is due, you will be or are precluded from accessing CEDRI or CDX and submitting a required report within the time prescribed, you may assert a claim of the EPA system outage for failure to timely comply with the reporting requirement. You must submit notification to the Administrator in writing as soon as possible following the date you first knew, or through due diligence should have known, that the event may cause or caused a delay in reporting. You must provide to the Administrator a written description identifying the date, time, and length of the outage; a rationale for attributing the delay in reporting beyond the regulatory deadline to the EPA system outage; describe the measures taken or to be taken to minimize the delay in reporting; and identify a date by which you propose to report, or if you have already met the reporting requirement at the time of the notification, the date you reported. In any circumstance, the report must be submitted electronically as soon as possible after the outage is resolved. The decision to accept the claim of the EPA system outage and allow an extension to the reporting deadline is solely within the discretion of the Administrator.

(h) Reporting during force majeure events. If you are required to electronically submit a report through CEDRI in the EPA's CDX and a force majeure event is about to occur, occurs, or has occurred or there are lingering effects from such an event within the period of time beginning 5 business days prior to the date the submission is due, the owner or operator may assert a claim of force majeure for failure to timely comply with the reporting requirement. For the purposes of this section, a force majeure event is defined as an event that will be or has been caused by circumstances beyond the control of the affected facility, its contractors, or any entity controlled by the affected facility that prevents you from complying with the requirement to submit a report electronically within the time period prescribed. Examples of such events are acts of nature (e.g., hurricanes, earthquakes, or floods), acts of war or terrorism, or equipment failure or safety hazard beyond the control of the affected facility (e.g., large scale power outage). If you intend to assert a claim of force majeure, you must submit notification to the Administrator in writing as soon as possible following the date you first knew, or through due diligence should have known, that the event may cause or caused a delay in reporting. You must provide to the Administrator a written description of the force majeure event and a rationale for attributing the delay in reporting beyond the regulatory deadline to

**SECTION E. Source Group Restrictions.**

the force majeure event; describe the measures taken or to be taken to minimize the delay in reporting; and identify a date by which you propose to report, or if you have already met the reporting requirement at the time of the notification, the date you reported. In any circumstance, the reporting must occur as soon as possible after the force majeure event occurs. The decision to accept the claim of force majeure and allow an extension to the reporting deadline is solely within the discretion of the Administrator.

[69 FR 157, Jan. 2, 2004, as amended at 85 FR 41138, July 8, 2020]

§63.3930 What records must I keep?

You must collect and keep records of the data and information specified in this section. Failure to collect and keep these records is a deviation from the applicable standard.

(a) A copy of each notification and report that you submitted to comply with this subpart, and the documentation supporting each notification and report. If you are using the predominant activity alternative under §63.3890(c), you must keep records of the data and calculations used to determine the predominant activity. If you are using the facility-specific emission limit alternative under §63.3890(c), you must keep records of the data used to calculate the facility-specific emission limit for the initial compliance demonstration. You must also keep records of any data used in each annual predominant activity determination and in the calculation of the facility-specific emission limit for each 12-month compliance period included in the semi-annual compliance reports.

(b) A current copy of information provided by materials suppliers or manufacturers, such as manufacturer's formulation data, or test data used to determine the mass fraction of organic HAP and density for each coating, thinner and/or other additive, and cleaning material, and the volume fraction of coating solids for each coating. If you conducted testing to determine mass fraction of organic HAP, density, or volume fraction of coating solids, you must keep a copy of the complete test report. If you use information provided to you by the manufacturer or supplier of the material that was based on testing, you must keep the summary sheet of results provided to you by the manufacturer or supplier. You are not required to obtain the test report or other supporting documentation from the manufacturer or supplier.

(c) For each compliance period, the records specified in paragraphs (c)(1) through (4) of this section.

(1) A record of the coating operations on which you used each compliance option and the time periods (beginning and ending dates and times) for each option you used.

(2) [NA - EMISSION RATE WITHOUT ADD-ON CONTROL OPTION USED]

(3) For the emission rate without add-on controls option, a record of the calculation of the total mass of organic HAP emissions for the coatings, thinners and/or other additives, and cleaning materials used each month using Equations 1, 1A through 1C, and 2 of §63.3951; and, if applicable, the calculation used to determine mass of organic HAP in waste materials according to §63.3951(e)(4); the calculation of the total volume of coating solids used each month using Equation 2 of §63.3951; and the calculation of each 12-month organic HAP emission rate using Equation 3 of §63.3951.

(4) [NA - EMISSION RATE WITHOUT ADD-ON CONTROL OPTION USED]

(d) A record of the name and volume of each coating, thinner and/or other additive, and cleaning material used during each compliance period. If you are using the compliant material option for all coatings at the source, you may maintain purchase records for each material used rather than a record of the volume used.

(e) A record of the mass fraction of organic HAP for each coating, thinner and/or other additive, and cleaning material used during each compliance period unless the material is tracked by weight.

(f) A record of the volume fraction of coating solids for each coating used during each compliance period.

(g) If you use either the emission rate without add-on controls or the emission rate with add-on controls compliance option, the density for each coating, thinner and/or other additive, and cleaning material used during each compliance period.

(h) If you use an allowance in Equation 1 of §63.3951 for organic HAP contained in waste materials sent to or designated

**SECTION E. Source Group Restrictions.**

for shipment to a treatment, storage, and disposal facility (TSDF) according to §63.3951(e)(4), you must keep records of the information specified in paragraphs (h)(1) through (3) of this section.

(1) The name and address of each TSDF to which you sent waste materials for which you use an allowance in Equation 1 of §63.3951; a statement of which subparts under 40 CFR parts 262, 264, 265, and 266 apply to the facility; and the date of each shipment.

(2) Identification of the coating operations producing waste materials included in each shipment and the month or months in which you used the allowance for these materials in Equation 1 of §63.3951.

(3) The methodology used in accordance with §63.3951(e)(4) to determine the total amount of waste materials sent to or the amount collected, stored, and designated for transport to a TSDF each month; and the methodology to determine the mass of organic HAP contained in these waste materials. This must include the sources for all data used in the determination, methods used to generate the data, frequency of testing or monitoring, and supporting calculations and documentation, including the waste manifest for each shipment.

(i) [Reserved]

(j) Before January 5, 2021, you must keep records of the date, time, and duration of each deviation. On and after January 5, 2021, for each deviation from an emission limitation reported under § 63.3920(a)(5) through (7), a record of the information specified in paragraphs (j)(1) through (4) of this section, as applicable.

(1) The date, time, and duration of the deviation, as reported under § 63.3920(a)(5) through (7).

(2) A list of the affected sources or equipment for which the deviation occurred and the cause of the deviation, as reported under § 63.3920(a)(5) through (7).

(3) An estimate of the quantity of each regulated pollutant emitted over any applicable emission limit in § 63.3890 or any applicable operating limit in table 1 to this subpart, and a description of the method used to calculate the estimate, as reported under § 63.3920(a)(5) through (7).

(4) A record of actions taken to minimize emissions in accordance with § 63.3900(b) and any corrective actions taken to return the affected unit to its normal or usual manner of operation.

(k) [NA - EMISSION RATE WITHOUT ADD-ON CONTROL OPTION USED]

[69 FR 157, Jan. 2, 2004, as amended at 85 FR 41141, July 8, 2020]

§63.3931 In what form and for how long must I keep my records?

(a) Your records must be in a form suitable and readily available for expeditious review, according to § 63.10(b)(1). Where appropriate, the records may be maintained as electronic spreadsheets or as a database. On and after January 5, 2021, any records required to be maintained by this subpart that are in reports that were submitted electronically via the EPA's CEDRI may be maintained in electronic format. This ability to maintain electronic copies does not affect the requirement for facilities to make records, data, and reports available upon request to a delegated air agency or the EPA as part of an on-site compliance evaluation

(b) As specified in §63.10(b)(1), you must keep each record for 5 years following the date of each occurrence, measurement, maintenance, corrective action, report, or record.

(c) You must keep each record on-site for at least 2 years after the date of each occurrence, measurement, maintenance, corrective action, report, or record according to §63.10(b)(1). You may keep the records off-site for the remaining 3 years. [69 FR 157, Jan. 2, 2004, as amended at 85 FR 41141, July 8, 2020]

COMPLIANCE REQUIREMENTS FOR THE COMPLIANT MATERIAL OPTION

§63.3940 - 63.3942 [NA - EMISSION RATE WITHOUT ADD-ON CONTROL OPTION USED]

**SECTION E. Source Group Restrictions.****COMPLIANCE REQUIREMENTS FOR THE EMISSION RATE WITHOUT ADD-ON CONTROLS OPTION**

§63.3950 By what date must I conduct the initial compliance demonstration?

You must complete the initial compliance demonstration for the initial compliance period according to the requirements of §63.3951. The initial compliance period begins on the applicable compliance date specified in §63.3883 and ends on the last day of the 12th month following the compliance date. If the compliance date occurs on any day other than the first day of a month, then the initial compliance period extends through the end of that month plus the next 12 months. You must determine the mass of organic HAP emissions and volume of coating solids used each month and then calculate an organic HAP emission rate at the end of the initial compliance period. The initial compliance demonstration includes the calculations according to §63.3951 and supporting documentation showing that during the initial compliance period the organic HAP emission rate was equal to or less than the applicable emission limit in §63.3890.

§63.3951 How do I demonstrate initial compliance with the emission limitations?

You may use the emission rate without add-on controls option for any individual coating operation, for any group of coating operations in the affected source, or for all the coating operations in the affected source. You must use either the compliant material option or the emission rate with add-on controls option for any coating operation in the affected source for which you do not use this option. To demonstrate initial compliance using the emission rate without add-on controls option, the coating operation or group of coating operations must meet the applicable emission limit in §63.3890, but is not required to meet the operating limits or work practice standards in §§63.3892 and 63.3893, respectively. You must conduct a separate initial compliance demonstration for each general use, magnet wire, rubber-to-metal, and extreme performance fluoropolymer coating operation unless you are demonstrating compliance with a predominant activity or facility-specific emission limit as provided in §63.3890(c). If you are demonstrating compliance with a predominant activity or facility-specific emission limit as provided in §63.3890(c), you must demonstrate that all coating operations included in the predominant activity determination or calculation of the facility-specific emission limit comply with that limit. You must meet all the requirements of this section. When calculating the organic HAP emission rate according to this section, do not include any coatings, thinners and/or other additives, or cleaning materials used on coating operations for which you use the compliant material option or the emission rate with add-on controls option. You do not need to redetermine the mass of organic HAP in coatings, thinners and/or other additives, or cleaning materials that have been reclaimed on-site (or reclaimed off-site if you have documentation showing that you received back the exact same materials that were sent off-site) and reused in the coating operation for which you use the emission rate without add-on controls option. If you use coatings, thinners and/or other additives, or cleaning materials that have been reclaimed on-site, the amount of each used in a month may be reduced by the amount of each that is reclaimed. That is, the amount used may be calculated as the amount consumed to account for materials that are reclaimed.

- (a) Determine the mass fraction of organic HAP for each material. Determine the mass fraction of organic HAP for each coating, thinner and/or other additive, and cleaning material used during each month according to the requirements in §63.3941(a).
- (b) Determine the volume fraction of coating solids. Determine the volume fraction of coating solids (liter (gal) of coating solids per liter (gal) of coating) for each coating used during each month according to the requirements in §63.3941(b).
- (c) Determine the density of each material. Determine the density of each liquid coating, thinner and/or other additive, and cleaning material used during each month from test results using ASTM D1475–13 or ASTM D2111–10 (Reapproved 2015) (both incorporated by reference, see § 63.14), information from the supplier or manufacturer of the material, or reference sources providing density or specific gravity data for pure materials. If you are including powder coatings in the compliance determination, determine the density of powder coatings, using ASTM D5965–02 (Reapproved 2013) (incorporated by reference, see § 63.14), or information from the supplier. If there is disagreement between ASTM D1475–13 or ASTM D2111–10 (Reapproved 2015) test results and other such information sources, the test results will take precedence unless, after consultation you demonstrate to the satisfaction of the enforcement agency that the formulation data are correct. If you purchase materials or monitor consumption by weight instead of volume, you do not need to determine material density. Instead, you may use the material weight in place of the combined terms for density and volume in Equations 1A, 1B, 1C, and 2 of this section.
- (d) Determine the volume of each material used. Determine the volume (liters) of each coating, thinner and/or other additive, and cleaning material used during each month by measurement or usage records. If you purchase materials or monitor

**SECTION E. Source Group Restrictions.**

consumption by weight instead of volume, you do not need to determine the volume of each material used. Instead, you may use the material weight in place of the combined terms for density and volume in Equations 1A, 1B, and 1C of this section.

(e) Calculate the mass of organic HAP emissions. The mass of organic HAP emissions is the combined mass of organic HAP contained in all coatings, thinners and/or other additives, and cleaning materials used during each month minus the organic HAP in certain waste materials. Calculate the mass of organic HAP emissions using Equation 1 of this section.

[SEE REGULATION FOR EQUATION]

(1) Calculate the kg organic HAP in the coatings used during the month using Equation 1A of this section:

[SEE REGULATION FOR EQUATION]

(2) Calculate the kg of organic HAP in the thinners and/or other additives used during the month using Equation 1B of this section:

[SEE REGULATION FOR EQUATION]

(3) Calculate the kg organic HAP in the cleaning materials used during the month using Equation 1C of this section:

[SEE REGULATION FOR EQUATION]

(4) If you choose to account for the mass of organic HAP contained in waste materials sent or designated for shipment to a hazardous waste TSDF in Equation 1 of this section, then you must determine the mass according to paragraphs (e)(4)(i) through (iv) of this section.

(i) You may only include waste materials in the determination that are generated by coating operations in the affected source for which you use Equation 1 of this section and that will be treated or disposed of by a facility that is regulated as a TSDF under 40 CFR part 262, 264, 265, or 266. The TSDF may be either off-site or on-site. You may not include organic HAP contained in wastewater.

(ii) You must determine either the amount of the waste materials sent to a TSDF during the month or the amount collected and stored during the month and designated for future transport to a TSDF. Do not include in your determination any waste materials sent to a TSDF during a month if you have already included them in the amount collected and stored during that month or a previous month.

(iii) Determine the total mass of organic HAP contained in the waste materials specified in paragraph (e)(4)(ii) of this section.

(iv) You must document the methodology you use to determine the amount of waste materials and the total mass of organic HAP they contain, as required in §63.3930(h). If waste manifests include this information, they may be used as part of the documentation of the amount of waste materials and mass of organic HAP contained in them.

(f) Calculate the total volume of coating solids used. Determine the total volume of coating solids used, liters, which is the combined volume of coating solids for all the coatings used during each month, using Equation 2 of this section:

[SEE REGULATION FOR EQUATION]

(g) Calculate the organic HAP emission rate. Calculate the organic HAP emission rate for the compliance period, kg (lb) organic HAP emitted per liter (gal) coating solids used, using Equation 3 of this section:

[SEE REGULATION FOR EQUATION]

(h) Compliance demonstration. The organic HAP emission rate for the initial compliance period calculated using Equation 3 of this section must be less than or equal to the applicable emission limit for each subcategory in §63.3890 or the predominant activity or facility-specific emission limit allowed in §63.3890(c). You must keep all records as required by

**SECTION E. Source Group Restrictions.**

§§63.3930 and 63.3931. As part of the notification of compliance status required by §63.3910, you must identify the coating operation(s) for which you used the emission rate without add-on controls option and submit a statement that the coating operation(s) was (were) in compliance with the emission limitations during the initial compliance period because the organic HAP emission rate was less than or equal to the applicable emission limit in §63.3890, determined according to the procedures in this section.

[69 FR 157, Jan. 2, 2004, as amended at 85 FR 41141, July 8, 2020]

§63.3952 How do I demonstrate continuous compliance with the emission limitations?

(a) To demonstrate continuous compliance, the organic HAP emission rate for each compliance period, determined according to §63.3951(a) through (g), must be less than or equal to the applicable emission limit in §63.3890. A compliance period consists of 12 months. Each month after the end of the initial compliance period described in §63.3950 is the end of a compliance period consisting of that month and the preceding 11 months. You must perform the calculations in §63.3951(a) through (g) on a monthly basis using data from the previous 12 months of operation. If you are complying with a facility-specific emission limit under §63.3890(c), you must also perform the calculation using Equation 1 in §63.3890(c)(2) on a monthly basis using the data from the previous 12 months of operation.

(b) If the organic HAP emission rate for any 12-month compliance period exceeded the applicable emission limit in §63.3890, this is a deviation from the emission limitation for that compliance period and must be reported as specified in §§63.3910(c)(6) and 63.3920(a)(6).

(c) As part of each semiannual compliance report required by §63.3920, you must identify the coating operation(s) for which you used the emission rate without add-on controls option. If there were no deviations from the emission limitations, you must submit a statement that the coating operation(s) was (were) in compliance with the emission limitations during the reporting period because the organic HAP emission rate for each compliance period was less than or equal to the applicable emission limit in §63.3890, determined according to §63.3951(a) through (g).

(d) You must maintain records as specified in §§63.3930 and 63.3931.

COMPLIANCE REQUIREMENTS FOR THE EMISSION RATE WITH ADD-ON CONTROLS OPTION

§63.3960-68 [NA - EMISSION RATE WITHOUT ADD-ON CONTROL OPTION USED]

§ 63.3981 What definitions apply to this subpart? [INCORPORATED BY REFERENCE]

Regulatory Changes

Individual sources within this source group that are subject to 40 CFR Part 63 Subpart Mmmm shall comply with all applicable requirements of the Subpart. 40 CFR 63.13(a) requires submission of copies of all requests, reports and other communications to both the Department and the EPA.

The EPA copies shall be forwarded to:

Associate Director
United States Environmental Protection Agency
Region III, Enforcement & Compliance Assurance Division
Air, RCRA and Toxics Branch (3ED21)
Four Penn Center
1600 John F. Kennedy Boulevard
Philadelphia, Pennsylvania 19103-2852

Unless otherwise approved by DEP, the DEP copies shall be reported through the Department's Greenport PUP system available through: <https://greenport.pa.gov/ePermitPublicAccess/PublicSubmission/Home>

In the event that the Federal Subpart that is the subject of this Source Group is revised, the permittee shall comply with the revised version of the subpart, and shall not be required to comply with any provisions in this permit designated as having

**SECTION E. Source Group Restrictions.**

the subpart as their authority, to the extent that such permit provisions would be inconsistent with the applicable provisions of the revised subpart.

***** Permit Shield in Effect. *****

**SECTION E. Source Group Restrictions.**

Group Name: SG19 SMELTER ANNEX
 Group Description: Smelter Annex Battery Assembly

Sources included in this group

ID	Name
517	SMELTER ANNEX LID SEALER BOOTHS #1-24
728	EQUIPMENT DECONSTRUCTION BUILDING

I. RESTRICTIONS.**Emission Restriction(s).****# 001 [25 Pa. Code §127.441]****Operating permit terms and conditions.**

The permittee shall limit the particulate emissions to the outdoor atmosphere from these sources to the following as measured at the associated control devices and/or stacks:

- a. Source 517 (Smelter Annex Lid Sealer) - 0.0075 grain per dry standard cubic foot
- b. Source 728 (Equipment Deconstruction Bldg) - 0.001 grain per dry standard cubic foot

II. TESTING REQUIREMENTS.

No additional testing requirements exist except as provided in other sections of this permit including Section B (Title V General Requirements).

III. MONITORING REQUIREMENTS.**# 002 [25 Pa. Code §127.441]****Operating permit terms and conditions.**

Periodically read and record the visible emissions and the pressure drop across each control device and HEPA filter, while the sources are in operation. The frequency of these readings shall be weekly, except as provided in the Section C 90% Monitoring Condition of TVOP 06-05069.

Periodically conduct inspections of each control device, HEPA filter and associated equipment, as appropriate to complete the following:

1. Visually inspect the control device and equipment
2. Check for the proper removal of collected materials
3. Check for fugitive emissions from the control device

Perform a semiannual inspection and maintenance, as needed, of each fabric collector, HEPA filter and associated equipment. This includes the inspection and maintenance of each fabric collector and HEPA filter to ensure proper performance, including the structural and filter integrity of the collector.

The permittee shall record the results of each reading and inspection on the approved inspection sheets. Any corrective actions should also be recorded in this manner.

IV. RECORDKEEPING REQUIREMENTS.**# 003 [25 Pa. Code §127.441]****Operating permit terms and conditions.**

The pressure differential across each control device and HEPA filter shall be recorded on a weekly basis.

V. REPORTING REQUIREMENTS.

No additional reporting requirements exist except as provided in other sections of this permit including Section B (Title V General Requirements).

**SECTION E. Source Group Restrictions.****VI. WORK PRACTICE REQUIREMENTS.****# 004 [25 Pa. Code §127.441]****Operating permit terms and conditions.**

Equipment (a differential manometer or equivalent, as approved by the Department), shall be installed and maintained so that at any time the pressure drop across each fabric collector and/or HEPA filter can be measured.

VII. ADDITIONAL REQUIREMENTS.

No additional requirements exist except as provided in other sections of this permit including Section B (Title V General Requirements).

***** Permit Shield in Effect. *****

**SECTION E. Source Group Restrictions.**

Group Name: SG20 RACT III PRESUMPTIVE

Group Description: §§129.111 - 129.115 - RACT III Presumptive Requirements

Sources included in this group

ID	Name
133A	A-2 CONCASTER (SCIEN FC #1 & SCIEN FC #10)
156A	A-3 CONCAST (SCIEN FC 6)
182A	S-1 CONCAST (SCIENTIFIC FC #1)
214	SPRAY BOOTH- CENTRAL MAINT PAINT BOOTH
404	A-4 CONCASTING (SCIEN FC #2)
508	A-2 COS/ENVELOPE/CONCAST (SCIEN 10)
601A	EMERGENCY ENGINES PRE-2006
601B	EMERGENCY SI ENGINES POST-2006
601C	EMERGENCY CI ENGINES POST-2006
601D	NON-EMERGENCY GENERATORS PRE-2006
603	SMALL PARTS COATING OPERATION
604	IND BATTERY TOUCH-UP OPERATION
604B	IND BATTERY TOUCH-UP OPERATION (POST-2012)
699	5D SOURCES
700	MISC COMBUSTION SOURCES (NOT 5D, NOT EMERGENCY GEN)

I. RESTRICTIONS.

No additional requirements exist except as provided in other sections of this permit including Section B (Title V General Requirements).

II. TESTING REQUIREMENTS.

No additional testing requirements exist except as provided in other sections of this permit including Section B (Title V General Requirements).

III. MONITORING REQUIREMENTS.

No additional monitoring requirements exist except as provided in other sections of this permit including Section B (Title V General Requirements).

IV. RECORDKEEPING REQUIREMENTS.

No additional record keeping requirements exist except as provided in other sections of this permit including Section B (Title V General Requirements).

V. REPORTING REQUIREMENTS.

No additional reporting requirements exist except as provided in other sections of this permit including Section B (Title V General Requirements).

VI. WORK PRACTICE REQUIREMENTS.

No additional work practice requirements exist except as provided in other sections of this permit including Section B (Title V General Requirements).

VII. ADDITIONAL REQUIREMENTS.**# 001 [25 Pa. Code §127.441]****Operating permit terms and conditions.**

(a) SG20, §§129.111 - 129.115 - RACT III Presumptive Requirements, applies only to those emission units that were in operation prior to August 3, 2018.

**SECTION E. Source Group Restrictions.**

(b) The permittee shall install, maintain and operate the sources in accordance with the manufacturer's specifications and with good operating practices pursuant to 25 Pa Code § 129.112(c)(2), (c)(4) & (c)(10). Specifically:

- (1) Source IDs 214, 603, 604, 604B, 133A, 156A, 182A, 404, 508 - 25 Pa Code §129.112(c)(2)
- (2) Source IDs 699 & 700 - 25 Pa Code §129.112(c)(4)
- (3) Source IDs 601A, 601B & 601C - 25 Pa Code §129.112(c)(10)
- (4) Source IDs 601D - 25 Pa Code §129.112(c)(6)

(c) In accordance with 25 Pa. Code §129.115(f), the owner and operator of an air contamination source subject to this section and § § 129.111—129.114 shall keep records to demonstrate compliance with § § 129.111—129.114 and submit reports to the Department or appropriate approved local air pollution control agency in accordance with the applicable regulations in 25 Pa. Code, Part I, Subpart C, Article III (relating to air resources) and as specified in the operating permit or plan approval for the air contamination source as follows:

(1) The records shall include sufficient data and calculations to demonstrate that the requirements of § § 129.111—129.114 are met.

(i) For sources subject to 25 Pa. Code §§129.112(c)(2), EPM shall keep record to demonstrate that the VOC PTE of each affected source is less than 2.7 tons per year.

(ii) For sources subject to 25 Pa. Code §§129.112(c)(4), EPM shall keep records to demonstrate that the individual rated gross heat input of each affected source is less than 20 million British thermal units per hour (MMBtu/hr).

(iii) For sources subject to 25 Pa. Code §§129.112(c)(10), EPM shall keep records to demonstrate that each affected source operates less than 500 hours per 12-month rolling period.

(2) Data or information required to determine compliance shall be recorded and maintained in a time frame consistent with the averaging period of the requirement.

(3) The records necessary to determine compliance shall be reported to the Department or appropriate approved local air pollution control agency on a schedule specified in the applicable regulation or as otherwise specified in the operating permit or plan approval for the air contamination source.

(d) In accordance with 25 Pa. Code §129.115(k), all records shall be retained by the owner or operator for 5 years and made available to the Department or appropriate approved local air pollution control agency upon receipt of a written request from the Department or appropriate approved local air pollution control agency.

Note: Upon approval of the presumptive RACT 3 requirements in this group as a SIP revision, the conditions in RACT 2 Group SG10B shall be superseded by the presumptive RACT 3 requirements of this group, except for the 2.7 tpy VOC limits for Sources 214, 603, 604 & the aggregate of Sources 133A, 156A, 182A, 404, 508.

*** **Permit Shield in Effect.** ***

**SECTION E. Source Group Restrictions.**

Group Name: SG21 RACT III CBC

Group Description: §§129.111 - 129.115 - RACT III Case-by-Case Requirements

Sources included in this group

ID	Name
213	MISCELLANEOUS CHEM
605	BATTERY FINISHING
719	IND BATT FINISHING FOR A-3 (2 LINES)

I. RESTRICTIONS.

No additional requirements exist except as provided in other sections of this permit including Section B (Title V General Requirements).

II. TESTING REQUIREMENTS.

No additional testing requirements exist except as provided in other sections of this permit including Section B (Title V General Requirements).

III. MONITORING REQUIREMENTS.

No additional monitoring requirements exist except as provided in other sections of this permit including Section B (Title V General Requirements).

IV. RECORDKEEPING REQUIREMENTS.

No additional record keeping requirements exist except as provided in other sections of this permit including Section B (Title V General Requirements).

V. REPORTING REQUIREMENTS.

No additional reporting requirements exist except as provided in other sections of this permit including Section B (Title V General Requirements).

VI. WORK PRACTICE REQUIREMENTS.

No additional work practice requirements exist except as provided in other sections of this permit including Section B (Title V General Requirements).

VII. ADDITIONAL REQUIREMENTS.**# 001 [25 Pa. Code §127.441]****Operating permit terms and conditions.****I. Source 213 (Miscellaneous Chemicals)**

(a) The permittee shall minimize the VOC emissions from the miscellaneous solvent usage in the following manner:

- (1) All solvents shall be stored and transported in closed containers or pipes.
- (2) All rags containing solvent shall be placed into closed storage containers for storage.
- (3) All rags containing solvent shall be placed into sealed containers and disposed of.
- (4) Spills of materials containing VOC shall be minimized and shall be cleaned up immediately with cleaning cloths or alternative approved methods that will minimize the evaporation of VOC into the atmosphere.
- (5) Minimize VOC emissions from cleaning of application, storage, mixing, and conveying equipment by ensuring that equipment cleaning is performed without atomizing the cleaning solvent, and all spent solvent is captured in closed containers.
- (6) Where possible, use products subject to 25 Pa. Code 130 - Standards for Products

(b) The permittee shall record the quantity and identity of all VOC-containing materials used in Source 213 on the various sources on a monthly basis. These records shall be maintained and shall be made part of the permittee's annual "AIMS" report to the Department. The records shall be compiled into a monthly and 12-month rolling total format.

**SECTION E. Source Group Restrictions.**

(c) Manufacturer supplied VOC data sheets for all coatings and cleaning agents applied within the most recent five (5) years shall be maintained at the facility and be made available to the Department at any time upon request.

II. Source 605 (Battery Finishing) & 719 (Ind Batt Finishing for A-3 (2 Lines))

(a) The permittee shall minimize the VOC emissions from the battery finishing operations through the use of good management procedures and standard operating procedures including the following:

- (1) Employee training detailing practices to control cleaning solution usage to minimize emissions.
- (2) Controlled distribution of VOC containing cleaning solutions.
- (3) Periodic evaluation of alternative cleaning solutions (i.e. low-VOC or non-VOC materials).
- (4) Good housekeeping procedures for the storage, use, and disposal of cleaning solutions.
- (5) Periodic inspection of cleaning solution usage practices and procedures.
- (6) Keeping cleaning solution containers closed when not in use.
- (7) Monitoring, recordkeeping, and reporting of cleaning solution VOC content and usage.

(b) The permittee shall record the quantity and identity of all VOC-containing battery finishing materials used at the facility on a monthly basis. These records shall be maintained and shall be made part of the permittee's annual "AIMS" report to the Department. The records shall be compiled into a monthly and 12-month rolling total format.

(c) Manufacturer supplied VOC data sheets for all coatings and cleaning agents applied within the most recent five (5) years shall be maintained at the facility and be made available to the Department at any time upon request.

Note: Upon approval of the case-by-case RACT 3 requirements in this group as a SIP revision, the conditions in RACT 2 Group SG10C shall be superseded by the case-by-case RACT 3 requirements of this group.

***** Permit Shield in Effect. *****

**SECTION E. Source Group Restrictions.**

Group Name: SG22 SUBPART ZZZZ

Group Description: Pre-2006 Non-Emergency RICE

Sources included in this group

ID	Name
601D	NON-EMERGENCY GENERATORS PRE-2006

I. RESTRICTIONS.

No additional requirements exist except as provided in other sections of this permit including Section B (Title V General Requirements).

II. TESTING REQUIREMENTS.

No additional testing requirements exist except as provided in other sections of this permit including Section B (Title V General Requirements).

III. MONITORING REQUIREMENTS.

No additional monitoring requirements exist except as provided in other sections of this permit including Section B (Title V General Requirements).

IV. RECORDKEEPING REQUIREMENTS.

No additional record keeping requirements exist except as provided in other sections of this permit including Section B (Title V General Requirements).

V. REPORTING REQUIREMENTS.

No additional reporting requirements exist except as provided in other sections of this permit including Section B (Title V General Requirements).

VI. WORK PRACTICE REQUIREMENTS.

No additional work practice requirements exist except as provided in other sections of this permit including Section B (Title V General Requirements).

VII. ADDITIONAL REQUIREMENTS.**# 001 [25 Pa. Code §127.441]****Operating permit terms and conditions.**

Regulatory Changes

Individual sources within this source group that are subject to 40 CFR Part 63, Subpart ZZZZ - National Emission Standards for Hazardous Air Pollutants for Stationary Reciprocating Internal Combustion Engines shall comply with all applicable requirements of the Subpart. 40 CFR 63.13(a) requires submission of copies of all requests, reports and other communications to both the Department and the EPA.

The EPA copies shall be forwarded to:

Associate Director
 United States Environmental Protection Agency
 Region III, Enforcement & Compliance Assurance Division
 Air, RCRA and Toxics Branch (3ED21)
 Four Penn Center
 1600 John F. Kennedy Boulevard
 Philadelphia, Pennsylvania 19103-2852

Unless otherwise approved by DEP, the DEP copies shall be reported through the Department's Greenport PUP system available through: <https://greenport.pa.gov/ePermitPublicAccess/PublicSubmission/Home>

**SECTION E. Source Group Restrictions.**

In the event that the Federal Subpart that is the subject of this Source Group is revised, the permittee shall comply with the revised version of the subpart, and shall not be required to comply with any provisions in this permit designated as having the subpart as their authority, to the extent that such permit provisions would be inconsistent with the applicable provisions of the revised subpart.

002 [40 CFR Part 63 NESHAPS for Source Categories §40 CFR 63.6580]**Subpart ZZZZ - National Emissions Standards for Hazardous Air Pollutants for Stationary Reciprocating Internal Combustion Engines****What is the purpose of subpart ZZZZ?**

Subpart ZZZZ establishes national emission limitations and operating limitations for hazardous air pollutants (HAP) emitted from stationary reciprocating internal combustion engines (RICE) located at major and area sources of HAP emissions. This subpart also establishes requirements to demonstrate initial and continuous compliance with the emission limitations and operating limitations.

[73 FR page 3603, Jan. 18, 2008, eff. Mar. 18, 2008]

003 [40 CFR Part 63 NESHAPS for Source Categories §40 CFR 63.6585]**Subpart ZZZZ - National Emissions Standards for Hazardous Air Pollutants for Stationary Reciprocating Internal Combustion Engines****Am I subject to this subpart?**

You are subject to this subpart if you own or operate a stationary RICE at a major or area source of HAP emissions, except if the stationary RICE is being tested at a stationary RICE test cell/stand.

63.6585(a) A stationary RICE is any internal combustion engine which uses reciprocating motion to convert heat energy into mechanical work and which is not mobile. Stationary RICE differ from mobile RICE in that a stationary RICE is not a non-road engine as defined at 40 CFR 1068.30, and is not used to propel a motor vehicle or a vehicle used solely for competition.

63.6585(b) A major source of HAP emissions is a plant site that emits or has the potential to emit any single HAP at a rate of 10 tons (9.07 megagrams) or more per year or any combination of HAP at a rate of 25 tons (22.68 megagrams) or more per year, except that for oil and gas production facilities, a major source of HAP emissions is determined for each surface site.

63.6585(c) An area source of HAP emissions is a source that is not a major source.

63.6585(d) [NA - THE FACILITY IS A MAJOR SOURCE]

63.6585(e) [NA - RICE NOT USED FOR NATIONAL SECURITY]

63.6585(f) [NA - NOT EMERGENCY RICE]

[69 FR 33506, June 15, 2004, as amended at 73 FR 3603, Jan. 18, 2008; 78 FR 6700, Jan. 30, 2013; 87 FR 48607, Aug. 10, 2022]

004 [40 CFR Part 63 NESHAPS for Source Categories §40 CFR 63.6590]**Subpart ZZZZ - National Emissions Standards for Hazardous Air Pollutants for Stationary Reciprocating Internal Combustion Engines****What parts of my plant does this subpart cover?**

This subpart applies to each affected source.

63.6590(a) Affected source. An affected source is any existing, new, or reconstructed stationary RICE located at a major or area source of HAP emissions, excluding stationary RICE being tested at a stationary RICE test cell/stand.

63.6590(a)(1) Existing stationary RICE.

63.6590(a)(1)(i) [NA - ENGINES < 500 HP]

63.6590(a)(1)(ii) For stationary RICE with a site rating of less than or equal to 500 brake HP located at a major source of

**SECTION E. Source Group Restrictions.**

HAP emissions, a stationary RICE is existing if you commenced construction or reconstruction of the stationary RICE before June 12, 2006.

63.6590(a)(1)(iii) [NA - THE FACILITY IS A MAJOR SOURCE]

63.6590(a)(1)(iv) A change in ownership of an existing stationary RICE does not make that stationary RICE a new or reconstructed stationary RICE.

63.6590(a)(2) [NA - NOT A NEW STATIONARY RICE]

63.6590(a)(3) [NA - ENGINES ARE NOT RECONSTRUCTED RICE]

63.6590(b) [NA - ENGINES NOT SUBJECT TO LIMITED REQUIREMENTS]

63.6590(c) [NA - NOT SUBJECT TO REGULATIONS UNDER 40 CFR PART 60]

[69 FR 33506 preview citation details, June 15, 2004, as amended at 73 FR 3604, Jan. 18, 2008; 75 FR 9674, Mar. 3, 2010; 75 FR 37733, June 30, 2010; 75 FR 51588, Aug. 20, 2010; 78 FR 6700, Jan. 30, 2013; 87 FR 48607, Aug. 10, 2022]

005 [40 CFR Part 63 NESHAPS for Source Categories §40 CFR 63.6595]

Subpart ZZZZ - National Emissions Standards for Hazardous Air Pollutants for Stationary Reciprocating Internal Combustion Engines

When do I have to comply with this subpart?

63.6595(a) Affected Sources.

63.6595(a)(1) If you have an existing stationary RICE, excluding existing non-emergency CI stationary RICE, with a site rating of more than 500 brake HP located at a major source of HAP emissions, you must comply with the applicable emission limitations, operating limitations and other requirements no later than June 15, 2007. If you have an existing non-emergency CI stationary RICE with a site rating of more than 500 brake HP located at a major source of HAP emissions, an existing stationary CI RICE with a site rating of less than or equal to 500 brake HP located at a major source of HAP emissions, or an existing stationary CI RICE located at an area source of HAP emissions, you must comply with the applicable emission limitations, operating limitations, and other requirements no later than May 3, 2013. If you have an existing stationary SI RICE with a site rating of less than or equal to 500 brake HP located at a major source of HAP emissions, or an existing stationary SI RICE located at an area source of HAP emissions, you must comply with the applicable emission limitations, operating limitations, and other requirements no later than October 19, 2013.

63.6595(a)(2) [NA - ENGINES < 500 HP]

63.6595(a)(3) - (7) [NA - ENGINES ARE EXISTING]

63.6595(b) [NA - THE FACILITY IS A MAJOR SOURCE OF HAP EMISSIONS]

63.6595(c) If you own or operate an affected source, you must meet the applicable notification requirements in § 63.6645 and in 40 CFR part 63, subpart A.

[69 FR page 33506, June 15, 2004, as amended at 73 FR page 3604, Jan. 18, 2008; 75 FR page 9675, Mar. 3, 2010; 75 FR page 51589, Aug. 20, 2010; 78 FR page 6701, Jan. 30, 2013]

006 [40 CFR Part 63 NESHAPS for Source Categories §40 CFR 63.6602]

Subpart ZZZZ - National Emissions Standards for Hazardous Air Pollutants for Stationary Reciprocating Internal Combustion Engines

What emission limitations must I meet if I own or operate an existing stationary RICE with a site rating of equal to or less than 500 brake HP located at a major source of HAP emissions?

If you own or operate an existing stationary RICE with a site rating of equal to or less than 500 brake HP located at a major source of HAP emissions, you must comply with the emission limitations and other requirements in Table 2c to this subpart which apply to you. Compliance with the numerical emission limitations established in this subpart is based on the results of testing the average of three 1-hour runs using the testing requirements and procedures in § 63.6620 and Table 4 to this subpart. [ENGINES ARE NOT SUBJECT TO NUMERICAL EMISSION LIMITATIONS]

**SECTION E. Source Group Restrictions.**

TABLE 2c REQUIREMENTS

For each ...

8. Non-Emergency, non-black start 2SLB stationary SI RICE <100 HP

You must meet the following requirement, except during periods of startup ...

- a. Change oil and filter every 4,320 hours of operation or annually, whichever comes first; NOTE 2
- b. Inspect spark plugs every 4,320 hours of operation or annually, whichever comes first, and replace as necessary;
- c. Inspect all hoses and belts every 4,320 hours of operation or annually, whichever comes first, and replace as necessary. NOTE 3

During periods of startup you must...

Minimize the engine's time spent at idle and minimize the engine's startup time at startup to a period needed for appropriate and safe loading of the engine, not to exceed 30 minutes, after which time the non-startup emission limitations apply. NOTE 3

NOTE 2: Sources have the option to utilize an oil analysis program as described in § 63.6625(i) or (j) in order to extend the specified oil change requirement in Table 2c of this subpart.

NOTE 3: Sources can petition the Administrator pursuant to the requirements of 40 CFR 63.6(g) for alternative work practices.

END OF TABLE 2c REQUIREMENTS

[78 FR 6701, Jan. 30, 2013]

007 [40 CFR Part 63 NESHAPS for Source Categories §40 CFR 63.6605]**Subpart ZZZZ - National Emissions Standards for Hazardous Air Pollutants for Stationary Reciprocating Internal Combustion Engines****What are my general requirements for complying with this subpart?**

63.6605(a) You must be in compliance with the emission limitations, operating limitations, and other requirements in this subpart that apply to you at all times.

63.6605(b) At all times you must operate and maintain any affected source, including associated air pollution control equipment and monitoring equipment, in a manner consistent with safety and good air pollution control practices for minimizing emissions. The general duty to minimize emissions does not require you to make any further efforts to reduce emissions if levels required by this standard have been achieved. Determination of whether such operation and maintenance procedures are being used will be based on information available to the Administrator which may include, but is not limited to, monitoring results, review of operation and maintenance procedures, review of operation and maintenance records, and inspection of the source.

[75 FR 9675, Mar. 3, 2010, as amended at 78 FR 6702, Jan. 30, 2013]

008 [40 CFR Part 63 NESHAPS for Source Categories §40 CFR 63.6612]**Subpart ZZZZ - National Emissions Standards for Hazardous Air Pollutants for Stationary Reciprocating Internal Combustion Engines****By what date must I conduct the initial performance tests or other initial compliance demonstrations if I own or operate an existing stationary RICE with a site rating of less than or equal to 500 brake (please see below)**

[NA - PERFORMANCE TEST NOT REQUIRED]

009 [40 CFR Part 63 NESHAPS for Source Categories §40 CFR 63.6625]**Subpart ZZZZ - National Emissions Standards for Hazardous Air Pollutants for Stationary Reciprocating Internal Combustion Engines****What are my monitoring, installation, operation, and maintenance requirements?**

63.6625(a) [NA - CEMS NOT INSTALLED]

63.6625(b) [NA - NOT REQUIRED TO INSTALL CPMS]

63.6625(c) [NA - ENGINES DO NOT COMBUST LFG OR DIGESTER GAS]

**SECTION E. Source Group Restrictions.**

63.6625(d) - (j) [NA - ENGINES < 100 HP]

63.6625(e) If you own or operate any of the following stationary RICE, you must operate and maintain the stationary RICE and after-treatment control device (if any) according to the manufacturer's emission-related written instructions or develop your own maintenance plan which must provide to the extent practicable for the maintenance and operation of the engine in a manner consistent with good air pollution control practice for minimizing emissions:

63.6625(e)(1) An existing stationary RICE with a site rating of less than 100 HP located at a major source of HAP emissions;

63.6625(e)(2) - (3) [NA - ENGINES ARE NON-EMERGENCY]

63.6625(e)(4) [NA - ENGINES ARE SI]

63.6625(e)(5) - (9) [NA - THE FACILITY IS A MAJOR SOURCE OF HAP EMISSIONS]

63.6625(e)(10) [NA - ENGINES < 100 HP]

63.6625(f) [NA - ENGINES ARE NON-EMERGENCY]

63.6625(h) If you operate a new, reconstructed, or existing stationary engine, you must minimize the engine's time spent at idle during startup and minimize the engine's startup time to a period needed for appropriate and safe loading of the engine, not to exceed 30 minutes, after which time the emission standards applicable to all times other than startup in Tables 1a, 2a, 2c, and 2d to this subpart apply.

63.6625(i) [NA - ENGINES ARE SI]

63.6625(j) If you own or operate a stationary SI engine that is subject to the work, operation or management practices in items 6, 7, or 8 of Table 2c to this subpart or in items 5, 6, 7, 9, or 11 of Table 2d to this subpart, you have the option of utilizing an oil analysis program in order to extend the specified oil change requirement in Tables 2c and 2d to this subpart. The oil analysis must be performed at the same frequency specified for changing the oil in Table 2c or 2d to this subpart. The analysis program must at a minimum analyze the following three parameters: Total Acid Number, viscosity, and percent water content. The condemning limits for these parameters are as follows: Total Acid Number increases by more than 3.0 milligrams of potassium hydroxide (KOH) per gram from Total Acid Number of the oil when new; viscosity of the oil has changed by more than 20 percent from the viscosity of the oil when new; or percent water content (by volume) is greater than 0.5. If all of these condemning limits are not exceeded, the engine owner or operator is not required to change the oil. If any of the limits are exceeded, the engine owner or operator must change the oil within 2 business days of receiving the results of the analysis; if the engine is not in operation when the results of the analysis are received, the engine owner or operator must change the oil within 2 business days or before commencing operation, whichever is later. The owner or operator must keep records of the parameters that are analyzed as part of the program, the results of the analysis, and the oil changes for the engine. The analysis program must be part of the maintenance plan for the engine.

[69 FR page 33506, June 15, 2004, as amended at 73 FR page 3606, Jan. 18, 2008; 75 FR page 9676, Mar. 3, 2010; 75 FR page 51589, Aug. 20, 2010; 76 FR page 12866, Mar. 9, 2011; 78 FR page 6703, Jan. 30, 2013]

010 [40 CFR Part 63 NESHAPS for Source Categories §40 CFR 63.6640]

Subpart ZZZZ - National Emissions Standards for Hazardous Air Pollutants for Stationary Reciprocating Internal Combustion Engines

How do I demonstrate continuous compliance with the emission limitations, operating limitations, and other requirements?

63.6640(a) You must demonstrate continuous compliance with each emission limitation, operating limitation, and other requirements in Tables 1a and 1b, Tables 2a and 2b, Table 2c, and Table 2d to this subpart that apply to you according to methods specified in Table 6 to this subpart.

TABLE 6 REQUIREMENTS

For each...

**SECTION E. Source Group Restrictions.**

9. Existing emergency and black start stationary RICE =500 HP located at a major source of HAP, existing non-emergency stationary RICE <100 HP located at a major source of HAP, existing emergency and black start stationary RICE located at an area source of HAP, existing non-emergency stationary CI RICE =300 HP located at an area source of HAP, existing non-emergency 2SLB stationary RICE located at an area source of HAP, existing non-emergency stationary SI RICE located at an area source of HAP which combusts landfill or digester gas equivalent to 10 percent or more of the gross heat input on an annual basis, existing non-emergency 4SLB and 4SRB stationary RICE =500 HP located at an area source of HAP, existing non-emergency 4SLB and 4SRB stationary RICE >500 HP located at an area source of HAP that operate 24 hours or less per calendar year, and existing non-emergency 4SLB and 4SRB stationary RICE >500 HP located at an area source of HAP that are remote stationary RICE.

Complying with the requirement to...

- a. Work or Management practices

You must demonstrate continuous compliance by...

- i. Operating and maintaining the stationary RICE according to the manufacturer's emission-related operation and maintenance instructions; or
 ii. Develop and follow your own maintenance plan which must provide to the extent practicable for the maintenance and operation of the engine in a manner consistent with good air pollution control practice for minimizing emissions.

END OF TABLE 6 REQUIREMENTS

63.6640(b) [NA - EXISTING ENGINES < 100 HP NOT REQUIRED TO SUBMIT REPORTS PER 63.6645(a)(5)]

63.6640(c) [NA - ENGINES < 500 HP]

63.6640(d) [NA - ENGINES ARE EXISTING]

63.6640(e) [NA - EXISTING ENGINES < 100 HP NOT REQUIRED TO SUBMIT REPORTS PER 63.6645(a)(5)]

63.6640(f) [NA - ENGINES ARE NON-EMERGENCY]

[69 FR 33506, June 15, 2004, as amended at 71 FR 20467, Apr. 20, 2006; 73 FR 3606, Jan. 18, 2008; 75 FR 9676, Mar. 3, 2010; 75 FR 51591, Aug. 20, 2010; 78 FR 6704, Jan. 30, 2013; 87 FR 48607, Aug. 10, 2022]

011 [40 CFR Part 63 NESHAPS for Source Categories §40 CFR 63.6645]

Subpart ZZZZ - National Emissions Standards for Hazardous Air Pollutants for Stationary Reciprocating Internal Combustion Engines

What notifications must I submit and when?

63.6645(a) You must submit all of the notifications in § 63.7(b) and (c), 63.8(e), (f)(4) and (f)(6), 63.9(b) through (e), and (g) and (h) that apply to you by the dates specified if you own or operate any of the following;

63.6645(a)(1) [NA - EXEMPT PER 63.6645(a)(5)]

63.6645(a)(2) [NA - THE FACILITY IS A MAJOR SOURCE OF HAP EMISSIONS]

63.6645(a)(3) [NA - ENGINES < 500 HP]

63.6645(a)(4) [NA - ENGINES ARE EXISTING]

63.6645(a)(5) This requirement does not apply if you own or operate an existing stationary RICE less than 100 HP, an existing stationary emergency RICE, or an existing stationary RICE that is not subject to any numerical emission standards.

63.6645(b) - (c) [NA - ENGINES < 500 HP]

63.6645(d) [NA - NOTIFICATION EXEMPT PER 63.6645(a)(5)]

63.6645(e) [NA - ENGINES STARTED RIOR TO 3/18/08]

**SECTION E. Source Group Restrictions.**

63.6645(f) [NA - NOTIFICATION EXEMPT PER 63.6645(a)(5)]

63.6645(g) [NA - PERFORMANCE TEST NOT REQUIRED]

63.6645(h) [NA - PERFORMANCE TEST AND/OR OTHER INITIAL COMPLIANCE DEMONSTRATION AS SPECIFIED IN TABLES 4 AND 5 TO MACT SUBPART ZZZZ NOT REQUIRED]

63.6645(i) [NA - ENGINES ARE SI]

[73 FR 3606, Jan. 18, 2008, as amended at 75 FR 9677, Mar. 3, 2010; 75 FR 51591, Aug. 20, 2010; 78 FR 6705preview citation details, Jan. 30, 2013; 85 FR 73912preview citation details, Nov. 19, 2020]

012 [40 CFR Part 63 NESHAPS for Source Categories §40 CFR 63.6650]

Subpart ZZZZ - National Emissions Standards for Hazardous Air Pollutants for Stationary Reciprocating Internal Combustion Engines

What reports must I submit and when?

[NA - EXISTING NON-EMERGENCY ENGINES < 100 HP NOT REQUIRED TO SUBMIT REPORTS]

013 [40 CFR Part 63 NESHAPS for Source Categories §40 CFR 63.6655]

Subpart ZZZZ - National Emissions Standards for Hazardous Air Pollutants for Stationary Reciprocating Internal Combustion Engines

What records must I keep?

63.6655(a) If you must comply with the emission and operating limitations, you must keep the records described in paragraphs (a)(1) through (a)(5), (b)(1) through (b)(3) and (c) of this section.

63.6655(a)(1) A copy of each notification and report that you submitted to comply with this subpart, including all documentation supporting any Initial Notification or Notification of Compliance Status that you submitted, according to the requirement in § 63.10(b)(2)(xiv).

63.6655(a)(2) Records of the occurrence and duration of each malfunction of operation (i.e., process equipment) or the air pollution control and monitoring equipment.

63.6655(a)(3) Records of performance tests and performance evaluations as required in § 63.10(b)(2)(viii).

63.6655(a)(4) Records of all required maintenance performed on the air pollution control and monitoring equipment.

63.6655(a)(5) Records of actions taken during periods of malfunction to minimize emissions in accordance with § 63.6605(b), including corrective actions to restore malfunctioning process and air pollution control and monitoring equipment to its normal or usual manner of operation.

63.6655(b) [NA - NO CEM OR CPMS]

63.6655(c) [NA - ENGINES DO NOT COMBUST LFG OR DIGESTER GAS]

63.6655(d) You must keep the records required in Table 6 of this subpart to show continuous compliance with each emission or operating limitation that applies to you.

63.6655(e) You must keep records of the maintenance conducted on the stationary RICE in order to demonstrate that you operated and maintained the stationary RICE and after-treatment control device (if any) according to your own maintenance plan if you own or operate any of the following stationary RICE;

63.6655(e)(1) An existing stationary RICE with a site rating of less than 100 brake HP located at a major source of HAP emissions.

63.6655(e)(2) [NA - ENGINES ARE NON-EMERGENCY]

63.6655(e)(3) [NA - THE FACILITY IS A MAJOR SOURCE OF HAPS]

**SECTION E. Source Group Restrictions.**

63.6655(f) [NA - ENGINES ARE NON-EMERGENCY]

[69 FR 33506, June 15, 2004, as amended at 75 FR 9678, Mar. 3, 2010; 75 FR 51592, Aug. 20, 2010; 78 FR 6706, Jan. 30, 2013; 87 FR 48607, Aug. 10, 2022]

014 [40 CFR Part 63 NESHAPS for Source Categories §40 CFR 63.6660]

Subpart ZZZZ - National Emissions Standards for Hazardous Air Pollutants for Stationary Reciprocating Internal Combustion Engines

In what form and how long must I keep my records?

63.6660(a) Your records must be in a form suitable and readily available for expeditious review according to § 63.10(b)(1).

63.6660(b) As specified in § 63.10(b)(1), you must keep each record for 5 years following the date of each occurrence, measurement, maintenance, corrective action, report, or record.

63.6660(c) You must keep each record readily accessible in hard copy or electronic form for at least 5 years after the date of each occurrence, measurement, maintenance, corrective action, report, or record, according to § 63.10(b)(1).

[69 FR page 33506, June 15, 2004, as amended at 75 FR page 9678, Mar. 3, 2010]

015 [40 CFR Part 63 NESHAPS for Source Categories §40 CFR 63.6665]

Subpart ZZZZ - National Emissions Standards for Hazardous Air Pollutants for Stationary Reciprocating Internal Combustion Engines

What parts of the General Provisions apply to me?

Table 8 to this subpart shows which parts of the General Provisions in §§ 63.1 through 63.15 apply to you. If you own or operate a new or reconstructed stationary RICE with a site rating of less than or equal to 500 brake HP located at a major source of HAP emissions (except new or reconstructed 4SLB engines greater than or equal to 250 and less than or equal to 500 brake HP), a new or reconstructed stationary RICE located at an area source of HAP emissions, or any of the following RICE with a site rating of more than 500 brake HP located at a major source of HAP emissions, you do not need to comply with any of the requirements of the General Provisions specified in Table 8: An existing 2SLB stationary RICE, an existing 4SLB stationary RICE, an existing stationary RICE that combusts landfill or digester gas equivalent to 10 percent or more of the gross heat input on an annual basis, an existing emergency stationary RICE, or an existing limited use stationary RICE. If you own or operate any of the following RICE with a site rating of more than 500 brake HP located at a major source of HAP emissions, you do not need to comply with the requirements in the General Provisions specified in Table 8 except for the initial notification requirements: A new stationary RICE that combusts landfill gas or digester gas equivalent to 10 percent or more of the gross heat input on an annual basis, a new emergency stationary RICE, or a new limited use stationary RICE.

[75 FR 9678, Mar. 3, 2010]

*** **Permit Shield in Effect.** ***



SECTION F. Alternative Operation Requirements.

No Alternative Operations exist for this Title V facility.



SECTION G. Emission Restriction Summary.

No emission restrictions listed in this section of the permit.

**SECTION H. Miscellaneous.**

#001

This permit includes the sources & conditions of Title V Operating Permit No. 06-05069, issued on 9/20/22 and amended on 5/8/24, & Plan Approval No. 06-05069AE. This permit supersedes those permits.

#002

The capacity/throughput values listed in this permit are for information purposes only and are not operating limits unless they are included within a condition in Section D or Section E.

#003

The Fugitive Stack Z400 is a grouping of various emissions from uncontrolled burner exhausts. Source 405 and 407 include various lead pots in which lead is melted for use in the processes. These pots are heated by burners that use natural gas or a propane-air mixture. The exhaust from this combustion is not directed to either a control device or stack. These fugitive emissions are not subject to 40 CFR Part 60, Subpart KK, Standards of Performance for New Stationary Sources.

#004

EPM's Lyon Station Battery Manufacturing Facility includes the following insignificant miscellaneous activities:

Source 606 - Central Services Wood Shop

Source 607 - Central Services Welding

Source 701 - A-1 Central Vacuum System

Plan Approval 06-05069AA added:

A) Two (2) make-up air units 2.250 mmBtu/hr each

B) Three (3) make-up air units 5.274 mmBtu/hr each

C) Three (3) make-up air units 3.614 mmBtu/hr each

RFDs approved the following additions:

1) On 3/5/15 in S-1 Maintenance Shop, RFD #1130 added fabric filter dust collector with secondary HEPA filtration

2) On 4/28/16 in IM1 Maintenance Shop, RFD #1354 added cartridge dust collector with secondary HEPA filtration

3) On 4/28/16 in Smelter Annex Maintenance Shop, RFD #1353 added cartridge dust collector with secondary HEPA filtration

4) On 6/19/18 in the Industrial Maintenance Shop, RFD #1865 added cartridge dust collector with secondary HEPA filtration

5) On 9/28/18 in the Machine Shop, RFD #1913 added a cartridge dust collector

6) On 4/9/19 in Tech Center Battery Laboratory, RFD #2016 added lab fume hood and scrubber

7) On 7/12/19 in Industrial Building Laboratory, RFD #2061 added a fabric filter dust collector and a Lab Fume Hood

8) On 2/5/2019 in the Industrial Facility, RFD #1979 added two 2.0-MMBtu/Hr natural gas-fired water heaters

9) On 6/11/2021 in Oxide Building No. 1, RFD #9249 added three general building exhaust fans

#005

40 CFR 63 Subpart DDDDD sources are:

EPM Internal

Tracking No.	Source Description	Classification
336	BOILER	1.47 mmBtu/hr
169	BOILER	5.5 mmBtu/hr
173	BOILER	6.0 mmBtu/hr

#006

Source 601A (Emergency Engines Pre-2006) includes the following emergency generator engines installed prior June 12, 2006, and subject to 40 CFR 63 Subpart ZZZZ:

ID#	BLDG	HP	FUEL
A2-025	A-2	26	NG
S1A-010	S1 ANNEX	16	NG
CS-024	CENTRAL	23	NG
IM-028	IM-2	150	NG
WTP-020	WTP	170	D

Source 601B (Emergency SI Engines Post-2006) includes the following natural gas fueled emergency generator engines subject to 40 CFR 60 Subpart JJJJ:

ID#	BLDG	BHP	START-UP	EPA Certified?
-----	------	-----	----------	----------------

**SECTION H. Miscellaneous.**

TC-040	TECH CENTER	150	2011	Yes (per manufacturer)
GE-044	SMELTER ANNEX	16	2012	Yes (per manufacturer)
GE-043	OXIDE 2	16	2012	Yes (per manufacturer)
GE-042	A-1	16	2013	Yes (per manufacturer)
GE-048	IM-1	44	2014	Yes (per manufacturer)
GE-056	MEDICAL	133	2015	Yes (per manufacturer)
GE-057	A-2	50	2016	Yes (per manufacturer)
GE-073	IND	115	2016	Yes (per manufacturer)
GE-074	OXIDE	50	2016	Yes (per manufacturer)
GE-078	IND	67	2017	Yes (per manufacturer)
GE-103	A-3	126	2024	Yes (per manufacturer)

TC-060 - 109 bhp

GE-072 - 158 bhp

Source 601C (Emergency CI Engines Post-2006) includes the following diesel fueled emergency generator engine subject to 40 CFR 60 Subpart IIII:

ID#	BLDG	BHP	START-UP	EPA Certified?
MO-039	MAIN OFFICE	109	2015	Yes (per manufacturer)
PU-3001	FIRE PUMP	316	2024	Yes (per manufacturer)

NOTE: Emergency Generator A4-035 was started up 6/1/2008. In accordance with 40 CFR 63.6585 the natural gas fueled, 136 HP engine is subject to 40 CFR 63 Subpart ZZZZ. In accordance with 40 CFR 63.6590(a)(2)(ii) and CFR 63.6590(c)(6), an engine manufactured after 6/12/2006 must meet the requirements of 40 CFR 63 Subpart ZZZZ by meeting the requirements of 40 CFR 60 Subpart JJJJ. However, 40 CFR 60.4230(a)(4)(iii) specifies that for engines with a maximum engine power less than 500 HP, Subpart JJJJ only applies if the engine was manufactured on or after 7/1/08, except as provided under 60.4230(a)(6). Since this engine was manufactured prior to 7/1/08, it is not subject to Subpart JJJJ, except as provided under 60.4230(a)(6). Therefore, the engine currently does not have to meet any requirements, except as provided under 60.4230(a)(6). The EPA may address requirements for engines manufactured between 6/12/2006 and 7/1/2008 through future rulemaking.

Source 601D (Emergency Engines Pre-2006) includes the following non-emergency generator engines installed prior June 12, 2006, and subject to 40 CFR 63 Subpart ZZZZ

ID#	BLDG	HP	FUEL
S1-017	S-1	41	NG

#007

Source 604 (Ind Battery Touch-Up Operation) consists of the following:

- (1) Finish line #1 Spray Booth/Touch-Up: Pre-1997
- (2) Finish Line #2 Spray Booth/Touch-Up: Pre-1997
- (3) Finish Line #3 Spray Booth/Touch-Up: Pre-1997

Source 604B (Ind Battery Touch-Up Operation) consists of the following:

- (1) Finish Line #4 Spray Booth/Touch-Up: July 2017
- (2) Finish Line #5 Spray Booth/Touch-Up: July 2017

#008

This is Revision No.4 of the facility's Title V Operating Permit issued on 9/20/22. This revision incorporates the requirements from PA 06-05069AE.



***** End of Report *****
